



Biopython Tutorial and Cookbook

Jeff Chang, Brad Chapman, Iddo Friedberg, Thomas Hamelryck,
Michiel de Hoon, Peter Cock, Tiago Antão

Last Update – 2 April 2010 (Biopython 1.54 *beta*)

Contents

| | | |
|----------|--|-----------|
| 1 | Introduction | 7 |
| 1.1 | What is Biopython? | 7 |
| 1.2 | What can I find in the Biopython package | 7 |
| 1.3 | Installing Biopython | 8 |
| 1.4 | Frequently Asked Questions (FAQ) | 8 |
| 2 | Quick Start – What can you do with Biopython? | 12 |
| 2.1 | General overview of what Biopython provides | 12 |
| 2.2 | Working with sequences | 12 |
| 2.3 | A usage example | 13 |
| 2.4 | Parsing sequence file formats | 14 |
| 2.4.1 | Simple FASTA parsing example | 14 |
| 2.4.2 | Simple GenBank parsing example | 15 |
| 2.4.3 | I love parsing – please don’t stop talking about it! | 15 |
| 2.5 | Connecting with biological databases | 15 |
| 2.6 | What to do next | 16 |
| 3 | Sequence objects | 17 |
| 3.1 | Sequences and Alphabets | 17 |
| 3.2 | Sequences act like strings | 18 |
| 3.3 | Slicing a sequence | 19 |
| 3.4 | Turning Seq objects into strings | 20 |
| 3.5 | Concatenating or adding sequences | 20 |
| 3.6 | Changing case | 21 |
| 3.7 | Nucleotide sequences and (reverse) complements | 21 |
| 3.8 | Transcription | 22 |
| 3.9 | Translation | 23 |
| 3.10 | Translation Tables | 25 |
| 3.11 | Comparing Seq objects | 27 |
| 3.12 | MutableSeq objects | 28 |
| 3.13 | UnknownSeq objects | 29 |
| 3.14 | Working with directly strings | 30 |
| 4 | Sequence Record objects | 31 |
| 4.1 | The SeqRecord object | 31 |
| 4.2 | Creating a SeqRecord | 32 |
| 4.2.1 | SeqRecord objects from scratch | 32 |
| 4.2.2 | SeqRecord objects from FASTA files | 33 |
| 4.2.3 | SeqRecord objects from GenBank files | 34 |
| 4.3 | SeqFeature objects | 35 |

| | | |
|----------|---|-----------|
| 4.3.1 | SeqFeatures themselves | 35 |
| 4.3.2 | Locations | 37 |
| 4.4 | References | 38 |
| 4.5 | The format method | 39 |
| 4.6 | Slicing a SeqRecord | 39 |
| 4.7 | Adding SeqRecord objects | 42 |
| 5 | Sequence Input/Output | 44 |
| 5.1 | Parsing or Reading Sequences | 44 |
| 5.1.1 | Reading Sequence Files | 44 |
| 5.1.2 | Iterating over the records in a sequence file | 45 |
| 5.1.3 | Getting a list of the records in a sequence file | 46 |
| 5.1.4 | Extracting data | 47 |
| 5.2 | Parsing sequences from the net | 49 |
| 5.2.1 | Parsing GenBank records from the net | 49 |
| 5.2.2 | Parsing SwissProt sequences from the net | 50 |
| 5.3 | Sequence files as Dictionaries – In memory | 50 |
| 5.3.1 | Specifying the dictionary keys | 51 |
| 5.3.2 | Indexing a dictionary using the SEGUID checksum | 52 |
| 5.4 | Sequence files as Dictionaries – Indexed files | 53 |
| 5.4.1 | Specifying the dictionary keys | 53 |
| 5.4.2 | Getting the raw data for a record | 54 |
| 5.4.3 | Discussion | 54 |
| 5.5 | Writing Sequence Files | 54 |
| 5.5.1 | Round trips | 56 |
| 5.5.2 | Converting between sequence file formats | 56 |
| 5.5.3 | Converting a file of sequences to their reverse complements | 57 |
| 5.5.4 | Getting your SeqRecord objects as formatted strings | 58 |
| 6 | Multiple Sequence Alignment objects | 59 |
| 6.1 | Parsing or Reading Sequence Alignments | 59 |
| 6.1.1 | Single Alignments | 60 |
| 6.1.2 | Multiple Alignments | 62 |
| 6.1.3 | Ambiguous Alignments | 64 |
| 6.2 | Writing Alignments | 66 |
| 6.2.1 | Converting between sequence alignment file formats | 67 |
| 6.2.2 | Getting your alignment objects as formatted strings | 69 |
| 6.3 | Manipulating Alignments | 69 |
| 6.4 | Alignment Tools | 72 |
| 6.4.1 | ClustalW | 72 |
| 6.4.2 | MUSCLE | 75 |
| 6.4.3 | MUSCLE using stdout | 76 |
| 6.4.4 | MUSCLE using stdin and stdout | 76 |
| 6.4.5 | EMBOSS needle and water | 77 |
| 7 | BLAST | 80 |
| 7.1 | Running BLAST over the Internet | 80 |
| 7.2 | Running BLAST locally | 82 |
| 7.2.1 | Introduction | 82 |
| 7.2.2 | Standalone NCBI “legacy” BLAST | 82 |
| 7.2.3 | Standalone NCBI BLAST+ | 82 |
| 7.2.4 | WU-BLAST and AB-BLAST | 83 |

| | | |
|----------|--|------------|
| 7.3 | Parsing BLAST output | 83 |
| 7.4 | The BLAST record class | 85 |
| 7.5 | Deprecated BLAST parsers | 86 |
| 7.5.1 | Parsing plain-text BLAST output | 86 |
| 7.5.2 | Parsing a plain-text BLAST file full of BLAST runs | 89 |
| 7.5.3 | Finding a bad record somewhere in a huge plain-text BLAST file | 90 |
| 7.6 | Dealing with PSI-BLAST | 91 |
| 7.7 | Dealing with RPS-BLAST | 91 |
| 8 | Accessing NCBI's Entrez databases | 92 |
| 8.1 | Entrez Guidelines | 93 |
| 8.2 | EInfo: Obtaining information about the Entrez databases | 93 |
| 8.3 | ESearch: Searching the Entrez databases | 95 |
| 8.4 | EPost: Uploading a list of identifiers | 96 |
| 8.5 | ESummary: Retrieving summaries from primary IDs | 97 |
| 8.6 | EFetch: Downloading full records from Entrez | 97 |
| 8.7 | ELink: Searching for related items in NCBI Entrez | 100 |
| 8.8 | EGQuery: Global Query - counts for search terms | 101 |
| 8.9 | ESpell: Obtaining spelling suggestions | 102 |
| 8.10 | Parsing huge Entrez XML files | 102 |
| 8.11 | Specialized parsers | 103 |
| 8.11.1 | Parsing Medline records | 103 |
| 8.11.2 | Parsing GEO records | 105 |
| 8.11.3 | Parsing UniGene records | 106 |
| 8.12 | Using a proxy | 107 |
| 8.13 | Examples | 108 |
| 8.13.1 | PubMed and Medline | 108 |
| 8.13.2 | Searching, downloading, and parsing Entrez Nucleotide records | 109 |
| 8.13.3 | Searching, downloading, and parsing GenBank records | 111 |
| 8.13.4 | Finding the lineage of an organism | 112 |
| 8.14 | Using the history and WebEnv | 113 |
| 8.14.1 | Searching for and downloading sequences using the history | 113 |
| 8.14.2 | Searching for and downloading abstracts using the history | 114 |
| 8.14.3 | Searching for citations | 114 |
| 9 | Swiss-Prot and ExpASy | 116 |
| 9.1 | Parsing Swiss-Prot files | 116 |
| 9.1.1 | Parsing Swiss-Prot records | 116 |
| 9.1.2 | Parsing the Swiss-Prot keyword and category list | 118 |
| 9.2 | Parsing Prosite records | 119 |
| 9.3 | Parsing Prosite documentation records | 120 |
| 9.4 | Parsing Enzyme records | 120 |
| 9.5 | Accessing the ExpASy server | 122 |
| 9.5.1 | Retrieving a Swiss-Prot record | 122 |
| 9.5.2 | Searching Swiss-Prot | 123 |
| 9.5.3 | Retrieving Prosite and Prosite documentation records | 123 |
| 9.6 | Scanning the Prosite database | 124 |

| | |
|---|------------|
| 10 Going 3D: The PDB module | 126 |
| 10.1 Structure representation | 126 |
| 10.1.1 Structure | 128 |
| 10.1.2 Model | 129 |
| 10.1.3 Chain | 129 |
| 10.1.4 Residue | 129 |
| 10.1.5 Atom | 130 |
| 10.2 Disorder | 131 |
| 10.2.1 General approach | 131 |
| 10.2.2 Disordered atoms | 131 |
| 10.2.3 Disordered residues | 131 |
| 10.3 Hetero residues | 132 |
| 10.3.1 Associated problems | 132 |
| 10.3.2 Water residues | 132 |
| 10.3.3 Other hetero residues | 132 |
| 10.4 Some random usage examples | 132 |
| 10.5 Common problems in PDB files | 133 |
| 10.5.1 Examples | 133 |
| 10.5.2 Automatic correction | 134 |
| 10.5.3 Fatal errors | 134 |
| 10.6 Other features | 135 |
| 11 Bio.PopGen: Population genetics | 136 |
| 11.1 GenePop | 136 |
| 11.2 Coalescent simulation | 138 |
| 11.2.1 Creating scenarios | 138 |
| 11.2.2 Running SIMCOAL2 | 140 |
| 11.3 Other applications | 141 |
| 11.3.1 FDist: Detecting selection and molecular adaptation | 141 |
| 11.4 Future Developments | 144 |
| 12 Supervised learning methods | 145 |
| 12.1 The Logistic Regression Model | 145 |
| 12.1.1 Background and Purpose | 145 |
| 12.1.2 Training the logistic regression model | 146 |
| 12.1.3 Using the logistic regression model for classification | 148 |
| 12.1.4 Logistic Regression, Linear Discriminant Analysis, and Support Vector Machines | 150 |
| 12.2 k -Nearest Neighbors | 150 |
| 12.2.1 Background and purpose | 150 |
| 12.2.2 Initializing a k -nearest neighbors model | 151 |
| 12.2.3 Using a k -nearest neighbors model for classification | 151 |
| 12.3 Naïve Bayes | 153 |
| 12.4 Maximum Entropy | 153 |
| 12.5 Markov Models | 153 |
| 13 Graphics including GenomeDiagram | 154 |
| 13.1 GenomeDiagram | 154 |
| 13.1.1 Introduction | 154 |
| 13.1.2 Diagrams, tracks, feature-sets and features | 154 |
| 13.1.3 A top down example | 155 |
| 13.1.4 A bottom up example | 157 |
| 13.1.5 Features without a SeqFeature | 157 |

| | | |
|-----------|---|------------|
| 13.1.6 | Feature captions | 158 |
| 13.1.7 | Feature sigils | 160 |
| 13.1.8 | A nice example | 160 |
| 13.1.9 | Further options | 163 |
| 13.1.10 | Converting old code | 164 |
| 13.2 | Chromosomes | 165 |
| 14 | Cookbook – Cool things to do with it | 168 |
| 14.1 | Working with sequence files | 168 |
| 14.1.1 | Producing randomised genomes | 168 |
| 14.1.2 | Translating a FASTA file of CDS entries | 170 |
| 14.1.3 | Sorting a sequence file | 170 |
| 14.1.4 | Simple quality filtering for FASTQ files | 171 |
| 14.1.5 | Trimming off primer sequences | 172 |
| 14.1.6 | Trimming off adaptor sequences | 173 |
| 14.1.7 | Converting FASTQ files | 174 |
| 14.1.8 | Converting FASTA and QUAL files into FASTQ files | 176 |
| 14.1.9 | Indexing a FASTQ file | 176 |
| 14.1.10 | Converting SFF files | 177 |
| 14.1.11 | Identifying open reading frames | 178 |
| 14.2 | Sequence parsing plus simple plots | 180 |
| 14.2.1 | Histogram of sequence lengths | 180 |
| 14.2.2 | Plot of sequence GC% | 181 |
| 14.2.3 | Nucleotide dot plots | 182 |
| 14.2.4 | Plotting the quality scores of sequencing read data | 185 |
| 14.3 | Dealing with alignments | 186 |
| 14.3.1 | Calculating summary information | 186 |
| 14.3.2 | Calculating a quick consensus sequence | 187 |
| 14.3.3 | Position Specific Score Matrices | 187 |
| 14.3.4 | Information Content | 189 |
| 14.4 | Substitution Matrices | 190 |
| 14.4.1 | Using common substitution matrices | 190 |
| 14.4.2 | Creating your own substitution matrix from an alignment | 190 |
| 14.5 | BioSQL – storing sequences in a relational database | 192 |
| 14.6 | InterPro | 192 |
| 15 | The Biopython testing framework | 193 |
| 15.1 | Running the tests | 193 |
| 15.2 | Writing tests | 194 |
| 15.2.1 | Writing a print-and-compare test | 195 |
| 15.2.2 | Writing a unittest-based test | 196 |
| 15.3 | Writing doctests | 199 |
| 16 | Advanced | 200 |
| 16.1 | Parser Design | 200 |
| 16.2 | Substitution Matrices | 200 |
| 16.2.1 | SubsMat | 200 |
| 16.2.2 | FreqTable | 203 |

| | |
|---|------------|
| 17 Where to go from here – contributing to Biopython | 205 |
| 17.1 Bug Reports + Feature Requests | 205 |
| 17.2 Mailing lists and helping newcomers | 205 |
| 17.3 Contributing Documentation | 205 |
| 17.4 Contributing cookbook examples | 205 |
| 17.5 Maintaining a distribution for a platform | 206 |
| 17.6 Contributing Unit Tests | 206 |
| 17.7 Contributing Code | 207 |
| 18 Appendix: Useful stuff about Python | 208 |
| 18.1 What the heck is a handle? | 208 |
| 18.1.1 Creating a handle from a string | 208 |

Chapter 1

Introduction

1.1 What is Biopython?

The Biopython Project is an international association of developers of freely available Python (<http://www.python.org>) tools for computational molecular biology. The web site <http://www.biopython.org> provides an online resource for modules, scripts, and web links for developers of Python-based software for life science research.

Basically, we just like to program in Python and want to make it as easy as possible to use Python for bioinformatics by creating high-quality, reusable modules and scripts.

1.2 What can I find in the Biopython package

The main Biopython releases have lots of functionality, including:

- The ability to parse bioinformatics files into Python utilizable data structures, including support for the following formats:
 - Blast output – both from standalone and WWW Blast
 - Clustalw
 - FASTA
 - GenBank
 - PubMed and Medline
 - ExPASy files, like Enzyme and Prosite
 - SCOP, including ‘dom’ and ‘lin’ files
 - UniGene
 - SwissProt
- Files in the supported formats can be iterated over record by record or indexed and accessed via a Dictionary interface.
- Code to deal with popular on-line bioinformatics destinations such as:
 - NCBI – Blast, Entrez and PubMed services
 - ExPASy – Swiss-Prot and Prosite entries, as well as Prosite searches
- Interfaces to common bioinformatics programs such as:

- Standalone Blast from NCBI
 - Clustalw alignment program
 - EMBOSS command line tools
- A standard sequence class that deals with sequences, ids on sequences, and sequence features.
 - Tools for performing common operations on sequences, such as translation, transcription and weight calculations.
 - Code to perform classification of data using k Nearest Neighbors, Naive Bayes or Support Vector Machines.
 - Code for dealing with alignments, including a standard way to create and deal with substitution matrices.
 - Code making it easy to split up parallelizable tasks into separate processes.
 - GUI-based programs to do basic sequence manipulations, translations, BLASTing, etc.
 - Extensive documentation and help with using the modules, including this file, on-line wiki documentation, the web site, and the mailing list.
 - Integration with BioSQL, a sequence database schema also supported by the BioPerl and BioJava projects.

We hope this gives you plenty of reasons to download and start using Biopython!

1.3 Installing Biopython

All of the installation information for Biopython was separated from this document to make it easier to keep updated.

The short version is go to our downloads page (<http://biopython.org/wiki/Download>), download and install the listed dependencies, then download and install Biopython. For Windows we provide pre-compiled click-and-run installers, while for Unix and other operating systems you must install from source as described in the included README file. This is usually as simple as the standard commands:

```
python setup.py build
python setup.py test
sudo python setup.py install
```

(You can in fact skip the build and test, and go straight to the install – but its better to make sure everything seems to be working.)

The longer version of our installation instructions covers installation of Python, Biopython dependencies and Biopython itself. It is available in PDF (<http://biopython.org/DIST/docs/install/Installation.pdf>) and HTML formats (<http://biopython.org/DIST/docs/install/Installation.html>).

1.4 Frequently Asked Questions (FAQ)

1. *How do I cite Biopython in a scientific publication?*

Please cite our application note, Cock *et al.* 2009, [doi:10.1093/bioinformatics/btp163](https://doi.org/10.1093/bioinformatics/btp163), and/or one of the publications listed on our website describing specific modules within Biopython.

2. *How should I capitalize “Biopython”? Is “BioPython” OK?*

The correct capitalization is “Biopython”, not “BioPython” (even though that would have matched BioPerl, BioJava and BioRuby).

3. *How do I find out what version of Biopython I have installed?*

Use this:

```
>>> import Bio
>>> print Bio.__version__
...
```

If the “import Bio” line fails, Biopython is not installed. If the second line fails, your version is very out of date. If the version string ends with a plus, you don’t have an official release, but a snapshot of the in development code.

4. *Where is the latest version of this document?*

If you download a Biopython source code archive, it will include the relevant version in both HTML and PDF formats. The latest published version of this document (updated at each release) is online:

- <http://biopython.org/DIST/docs/tutorial/Tutorial.html>
- <http://biopython.org/DIST/docs/tutorial/Tutorial.pdf>

If you are using the very latest unreleased code from our repository you can find copies of the in-progress tutorial here:

- <http://biopython.org/DIST/docs/tutorial/Tutorial-dev.html>
- <http://biopython.org/DIST/docs/tutorial/Tutorial-dev.pdf>

5. *Which “Numerical Python” do I need?*

For Biopython 1.48 or earlier, you needed the old Numeric module. For Biopython 1.49 onwards, you need the newer NumPy instead. Both Numeric and NumPy can be installed on the same machine fine. See also: <http://numpy.scipy.org/>

6. *Why is the Seq object missing the (back) transcription & translation methods described in this Tutorial?*

You need Biopython 1.49 or later. Alternatively, use the Bio.Seq module functions described in Section 3.14.

7. *Why is the Seq object missing the upper & lower methods described in this Tutorial?*

You need Biopython 1.53 or later. Alternatively, use `str(my_seq).upper()` to get an upper case string. If you need a Seq object, try `Seq(str(my_seq).upper())` but be careful about blindly re-using the same alphabet.

8. *Why doesn't the Seq object translation method support the cds option described in this Tutorial?*

You need Biopython 1.51 or later.

9. *Why doesn't Bio.SeqIO work? It imports fine but there is no parse function etc.*

You need Biopython 1.43 or later. Older versions did contain some related code under the Bio.SeqIO name which has since been removed - and this is why the import “works”.

10. *Why doesn't Bio.SeqIO.read() work? The module imports fine but there is no read function!*

You need Biopython 1.45 or later. Or, use `Bio.SeqIO.parse(...).next()` instead.

11. *Why isn't Bio.AlignIO present? The module import fails!*

You need Biopython 1.46 or later.

12. *What file formats do Bio.SeqIO and Bio.AlignIO read and write?*
Check the built in docstrings (from `Bio import SeqIO`, then `help(SeqIO)`), or see <http://biopython.org/wiki/SeqIO> and <http://biopython.org/wiki/AlignIO> on the wiki for the latest listing.
13. *Why don't the Bio.SeqIO and Bio.AlignIO input functions let me provide a sequence alphabet?*
You need Biopython 1.49 or later.
14. *Why won't the Bio.SeqIO and Bio.AlignIO functions parse, read and write take filenames? They insist on handles!*
You need Biopython 1.54 or later, or just use handles explicitly. It is especially important to remember to close output handles explicitly after writing your data.
15. *Why won't the Bio.SeqIO.write() and Bio.AlignIO.write() functions accept a single record or alignment? They insist on a list or iterator!*
You need Biopython 1.54 or later, or just wrap the item with `[...]` to create a list of one element.
16. *Why doesn't str(...) give me the full sequence of a Seq object?*
You need Biopython 1.45 or later. Alternatively, rather than `str(my_seq)`, use `my_seq.tostring()` (which will also work on recent versions of Biopython).
17. *Why doesn't Bio.Blast work with the latest plain text NCBI blast output?*
The NCBI keep tweaking the plain text output from the BLAST tools, and keeping our parser up to date is/was an ongoing struggle. If you aren't using the latest version of Biopython, you could try upgrading. However, we (and the NCBI) recommend you use the XML output instead, which is designed to be read by a computer program.
18. *Why doesn't Bio.Entrez.read() work? The module imports fine but there is no read function!*
You need Biopython 1.46 or later.
19. *Why doesn't Bio.Entrez.parse() work? The module imports fine but there is no parse function!*
You need Biopython 1.52 or later.
20. *Why doesn't Bio.PDB.MMCIFParser work? I see an import error about MMCIFlex*
Since Biopython 1.42, the underlying `Bio.PDB.mmCIF.MMCIFlex` module has not been installed by default. It requires a third party tool called flex (fast lexical analyzer generator). At the time of writing, you'll have install flex, then tweak your Biopython `setup.py` file and reinstall from source.
21. *Why doesn't Bio.Blast.NCBIXML.read() work? The module imports but there is no read function!*
You need Biopython 1.50 or later. Or, use `Bio.Blast.NCBIXML.parse(...).next()` instead.
22. *Why doesn't my SeqRecord object have a letter_annotations attribute?*
Per-letter-annotation support was added in Biopython 1.50.
23. *Why can't I slice my SeqRecord to get a sub-record?*
You need Biopython 1.50 or later.
24. *Why can't I add SeqRecord objects together?*
You need Biopython 1.53 or later.
25. *Why doesn't Bio.SeqIO.convert() or Bio.AlignIO.convert() work? The modules import fine but there is no convert function!*
You need Biopython 1.52 or later. Alternatively, combine the `parse` and `write` functions as described in this tutorial (see Sections [5.5.2](#) and [6.2.1](#)).
26. *Why doesn't Bio.SeqIO.index() work? The module imports fine but there is no index function!*
You need Biopython 1.52 or later.

27. *Where is the `MultipleSeqAlignment` object? The `Bio.Align` module imports fine but this class isn't there!*

You need Biopython 1.54 or later. Alternatively, the older `Bio.Align.Generic.Alignment` class supports some of its functionality, but using this is now discouraged.

28. *I looked in a directory for code, but I couldn't find the code that does something. Where's it hidden?*

One thing to know is that we put code in `__init__.py` files. If you are not used to looking for code in this file this can be confusing. The reason we do this is to make the imports easier for users. For instance, instead of having to do a “repetitive” import like `from Bio.GenBank import GenBank`, you can just use `from Bio import GenBank`.

29. *Why does the code from CVS seem out of date?*

In late September 2009, just after the release of Biopython 1.52, we switched from using CVS to git, a distributed version control system. The old CVS server will remain available as a static and read only backup, but if you want to grab the latest code, you'll need to use git instead. See our website for more details.

For more general questions, the Python FAQ pages <http://www.python.org/doc/faq/> may be useful.

Chapter 2

Quick Start – What can you do with Biopython?

This section is designed to get you started quickly with Biopython, and to give a general overview of what is available and how to use it. All of the examples in this section assume that you have some general working knowledge of Python, and that you have successfully installed Biopython on your system. If you think you need to brush up on your Python, the main Python web site provides quite a bit of free documentation to get started with (<http://www.python.org/doc/>).

Since much biological work on the computer involves connecting with databases on the internet, some of the examples will also require a working internet connection in order to run.

Now that that is all out of the way, let's get into what we can do with Biopython.

2.1 General overview of what Biopython provides

As mentioned in the introduction, Biopython is a set of libraries to provide the ability to deal with “things” of interest to biologists working on the computer. In general this means that you will need to have at least some programming experience (in Python, of course!) or at least an interest in learning to program. Biopython's job is to make your job easier as a programmer by supplying reusable libraries so that you can focus on answering your specific question of interest, instead of focusing on the internals of parsing a particular file format (of course, if you want to help by writing a parser that doesn't exist and contributing it to Biopython, please go ahead!). So Biopython's job is to make you happy!

One thing to note about Biopython is that it often provides multiple ways of “doing the same thing.” Things have improved in recent releases, but this can still be frustrating as in Python there should ideally be one right way to do something. However, this can also be a real benefit because it gives you lots of flexibility and control over the libraries. The tutorial helps to show you the common or easy ways to do things so that you can just make things work. To learn more about the alternative possibilities, look in the Cookbook (Chapter 14, this has some cool tricks and tips), the Advanced section (Chapter 16), the built in “docstrings” (via the Python help command, or the [API documentation](#)) or ultimately the code itself.

2.2 Working with sequences

Disputably (of course!), the central object in bioinformatics is the sequence. Thus, we'll start with a quick introduction to the Biopython mechanisms for dealing with sequences, the `Seq` object, which we'll discuss in more detail in Chapter 3.

Most of the time when we think about sequences we have in my mind a string of letters like 'AGTACTGTT'. You can create such `Seq` object with this sequence as follows - the ">>>" represents the Python prompt

followed by what you would type in:

```
>>> from Bio.Seq import Seq
>>> my_seq = Seq("AGTACTGGT")
>>> my_seq
Seq('AGTACTGGT', Alphabet())
>>> print my_seq
AGTACTGGT
>>> my_seq.alphabet
Alphabet()
```

What we have here is a sequence object with a *generic* alphabet - reflecting the fact we have *not* specified if this is a DNA or protein sequence (okay, a protein with a lot of Alanines, Glycines, Cysteines and Threonines!). We'll talk more about alphabets in Chapter 3.

In addition to having an alphabet, the `Seq` object differs from the Python string in the methods it supports. You can't do this with a plain string:

```
>>> my_seq
Seq('AGTACTGGT', Alphabet())
>>> my_seq.complement()
Seq('TCATGTGACCA', Alphabet())
>>> my_seq.reverse_complement()
Seq('ACCAGTGTACT', Alphabet())
```

The next most important class is the `SeqRecord` or Sequence Record. This holds a sequence (as a `Seq` object) with additional annotation including an identifier, name and description. The `Bio.SeqIO` module for reading and writing sequence file formats works with `SeqRecord` objects, which will be introduced below and covered in more detail by Chapter 5.

This covers the basic features and uses of the Biopython sequence class. Now that you've got some idea of what it is like to interact with the Biopython libraries, it's time to delve into the fun, fun world of dealing with biological file formats!

2.3 A usage example

Before we jump right into parsers and everything else to do with Biopython, let's set up an example to motivate everything we do and make life more interesting. After all, if there wasn't any biology in this tutorial, why would you want you read it?

Since I love plants, I think we're just going to have to have a plant based example (sorry to all the fans of other organisms out there!). Having just completed a recent trip to our local greenhouse, we've suddenly developed an incredible obsession with Lady Slipper Orchids (if you wonder why, have a look at some [Lady Slipper Orchids photos on Flickr](#), or try a [Google Image Search](#)).

Of course, orchids are not only beautiful to look at, they are also extremely interesting for people studying evolution and systematics. So let's suppose we're thinking about writing a funding proposal to do a molecular study of Lady Slipper evolution, and would like to see what kind of research has already been done and how we can add to that.

After a little bit of reading up we discover that the Lady Slipper Orchids are in the Orchidaceae family and the Cypripedioideae sub-family and are made up of 5 genera: *Cypripedium*, *Paphiopedilum*, *Phragmipedium*, *Selenipedium* and *Mexipedium*.

That gives us enough to get started delving for more information. So, let's look at how the Biopython tools can help us. We'll start with sequence parsing in Section 2.4, but the orchids will be back later on as well - for example we'll search PubMed for papers about orchids and extract sequence data from GenBank in Chapter 8, extract data from Swiss-Prot from certain orchid proteins in Chapter 9, and work with ClustalW multiple sequence alignments of orchid proteins in Section 6.4.1.

2.4 Parsing sequence file formats

A large part of much bioinformatics work involves dealing with the many types of file formats designed to hold biological data. These files are loaded with interesting biological data, and a special challenge is parsing these files into a format so that you can manipulate them with some kind of programming language. However the task of parsing these files can be frustrated by the fact that the formats can change quite regularly, and that formats may contain small subtleties which can break even the most well designed parsers.

We are now going to briefly introduce the `Bio.SeqIO` module – you can find out more in Chapter 5. We'll start with an online search for our friends, the lady slipper orchids. To keep this introduction simple, we're just using the NCBI website by hand. Let's just take a look through the nucleotide databases at NCBI, using an Entrez online search (<http://www.ncbi.nlm.nih.gov:80/entrez/query.fcgi?db=Nucleotide>) for everything mentioning the text `Cypripedioideae` (this is the subfamily of lady slipper orchids).

When this tutorial was originally written, this search gave us only 94 hits, which we saved as a FASTA formatted text file and as a GenBank formatted text file (files `ls_orchid.fasta` and `ls_orchid.gbk`, also included with the Biopython source code under `docs/tutorial/examples/`).

If you run the search today, you'll get hundreds of results! When following the tutorial, if you want to see the same list of genes, just download the two files above or copy them from `docs/examples/` in the Biopython source code. In Section 2.5 we will look at how to do a search like this from within Python.

2.4.1 Simple FASTA parsing example

If you open the lady slipper orchids FASTA file `ls_orchid.fasta` in your favourite text editor, you'll see that the file starts like this:

```
>gi|2765658|emb|Z78533.1|CIZ78533 C.irapeanum 5.8S rRNA gene and ITS1 and ITS2 DNA
CGTAACAAGGTTTCCGTAGGTGAACCTGCGGAAGGATCATTGATGAGACCGTGAATAAACGATCGAGTG
AATCCGGAGGACCGGTGTACTCAGCTCACCGGGGGCATTGCTCCCGTGGTGACCCTGATTTGTTGTTGGG
...
```

It contains 94 records, each has a line starting with ">" (greater-than symbol) followed by the sequence on one or more lines. Now try this in Python:

```
from Bio import SeqIO
for seq_record in SeqIO.parse("ls_orchid.fasta", "fasta"):
    print seq_record.id
    print repr(seq_record.seq)
    print len(seq_record)
```

You should get something like this on your screen:

```
gi|2765658|emb|Z78533.1|CIZ78533
Seq('CGTAACAAGGTTTCCGTAGGTGAACCTGCGGAAGGATCATTGATGAGACCGTGG...CGC', SingleLetterAlphabet())
740
...
gi|2765664|emb|Z78439.1|PBZ78439
Seq('CATTGTTGAGATCACATAATAATTGATCGAGTTAATCTGGAGGATCTGTTTACT...GCC', SingleLetterAlphabet())
592
```

Notice that the FASTA format does not specify the alphabet, so `Bio.SeqIO` has defaulted to the rather generic `SingleLetterAlphabet()` rather than something DNA specific.

2.4.2 Simple GenBank parsing example

Now let's load the GenBank file [ls_orchid.gbk](#) instead - notice that the code to do this is almost identical to the snippet used above for the FASTA file - the only difference is we change the filename and the format string:

```
from Bio import SeqIO
for seq_record in SeqIO.parse("ls_orchid.gbk", "genbank"):
    print seq_record.id
    print repr(seq_record.seq)
    print len(seq_record)
```

This should give:

```
Z78533.1
Seq('CGTAACAAGGTTTCCGTAGGTGAACCTGCGGAAGGATCATTGATGAGACCGTGG...CGC', IUPACAmbiguousDNA())
740
...
Z78439.1
Seq('CATTGTTGATCACATAATAATTGATCGAGTTAATCTGGAGGATCTGTTTACT...GCC', IUPACAmbiguousDNA())
592
```

This time `Bio.SeqIO` has been able to choose a sensible alphabet, IUPAC Ambiguous DNA. You'll also notice that a shorter string has been used as the `seq_record.id` in this case.

2.4.3 I love parsing – please don't stop talking about it!

Biopython has a lot of parsers, and each has its own little special niches based on the sequence format it is parsing and all of that. Chapter 5 covers `Bio.SeqIO` in more detail, while Chapter 6 introduces `Bio.AlignIO` for sequence alignments.

While the most popular file formats have parsers integrated into `Bio.SeqIO` and/or `Bio.AlignIO`, for some of the rarer and unloved file formats there is either no parser at all, or an old parser which has not been linked in yet. Please also check the wiki pages <http://biopython.org/wiki/SeqIO> and <http://biopython.org/wiki/AlignIO> for the latest information, or ask on the mailing list. The wiki pages should include an up to date list of supported file types, and some additional examples.

The next place to look for information about specific parsers and how to do cool things with them is in the Cookbook (Chapter 14 of this Tutorial). If you don't find the information you are looking for, please consider helping out your poor overworked documentors and submitting a cookbook entry about it! (once you figure out how to do it, that is!)

2.5 Connecting with biological databases

One of the very common things that you need to do in bioinformatics is extract information from biological databases. It can be quite tedious to access these databases manually, especially if you have a lot of repetitive work to do. Biopython attempts to save you time and energy by making some on-line databases available from Python scripts. Currently, Biopython has code to extract information from the following databases:

- [Entrez](#) (and [PubMed](#)) from the NCBI – See Chapter 8.
- [ExPASy](#) – See Chapter 9.
- [SCOP](#) – See the `Bio.SCOP.search()` function.

The code in these modules basically makes it easy to write Python code that interact with the CGI scripts on these pages, so that you can get results in an easy to deal with format. In some cases, the results can be tightly integrated with the Biopython parsers to make it even easier to extract information.

2.6 What to do next

Now that you've made it this far, you hopefully have a good understanding of the basics of Biopython and are ready to start using it for doing useful work. The best thing to do now is finish reading this tutorial, and then if you want start snooping around in the source code, and looking at the automatically generated documentation.

Once you get a picture of what you want to do, and what libraries in Biopython will do it, you should take a peak at the Cookbook (Chapter 14), which may have example code to do something similar to what you want to do.

If you know what you want to do, but can't figure out how to do it, please feel free to post questions to the main Biopython list (see http://biopython.org/wiki/Mailing_lists). This will not only help us answer your question, it will also allow us to improve the documentation so it can help the next person do what you want to do.

Enjoy the code!

Chapter 3

Sequence objects

Biological sequences are arguably the central object in Bioinformatics, and in this chapter we'll introduce the Biopython mechanism for dealing with sequences, the `Seq` object. Chapter 4 will introduce the related `SeqRecord` object, which combines the sequence information with any annotation, used again in Chapter 5 for Sequence Input/Output.

Sequences are essentially strings of letters like `AGTACTGGT`, which seems very natural since this is the most common way that sequences are seen in biological file formats.

There are two important differences between `Seq` objects and standard Python strings. First of all, they have different methods. Although the `Seq` object supports many of the same methods as a plain string, its `translate()` method differs by doing biological translation, and there are also additional biologically relevant methods like `reverse_complement()`. Secondly, the `Seq` object has an important attribute, `alphabet`, which is an object describing what the individual characters making up the sequence string “mean”, and how they should be interpreted. For example, is `AGTACTGGT` a DNA sequence, or just a protein sequence that happens to be rich in Alanines, Glycines, Cysteines and Threonines?

3.1 Sequences and Alphabets

The alphabet object is perhaps the important thing that makes the `Seq` object more than just a string. The currently available alphabets for Biopython are defined in the `Bio.Alphabet` module. We'll use the IUPAC alphabets (<http://www.chem.qmw.ac.uk/iupac/>) here to deal with some of our favorite objects: DNA, RNA and Proteins.

`Bio.Alphabet.IUPAC` provides basic definitions for proteins, DNA and RNA, but additionally provides the ability to extend and customize the basic definitions. For instance, for proteins, there is a basic `IUPACProtein` class, but there is an additional `ExtendedIUPACProtein` class providing for the additional elements “U” (or “Sec” for selenocysteine) and “O” (or “Pyl” for pyrrolysine), plus the ambiguous symbols “B” (or “Asx” for asparagine or aspartic acid), “Z” (or “Glx” for glutamine or glutamic acid), “J” (or “Xle” for leucine isoleucine) and “X” (or “Xxx” for an unknown amino acid). For DNA you've got choices of `IUPACUnambiguousDNA`, which provides for just the basic letters, `IUPACAmbiguousDNA` (which provides for ambiguity letters for every possible situation) and `ExtendedIUPACDNA`, which allows letters for modified bases. Similarly, RNA can be represented by `IUPACAmbiguousRNA` or `IUPACUnambiguousRNA`.

The advantages of having an alphabet class are two fold. First, this gives an idea of the type of information the `Seq` object contains. Secondly, this provides a means of constraining the information, as a means of type checking.

Now that we know what we are dealing with, let's look at how to utilize this class to do interesting work. You can create an ambiguous sequence with the default generic alphabet like this:

```
>>> from Bio.Seq import Seq
```

```

>>> my_seq = Seq("AGTACTGGT")
>>> my_seq
Seq('AGTACTGGT', Alphabet())
>>> my_seq.alphabet
Alphabet()

```

However, where possible you should specify the alphabet explicitly when creating your sequence objects - in this case an unambiguous DNA alphabet object:

```

>>> from Bio.Seq import Seq
>>> from Bio.Alphabet import IUPAC
>>> my_seq = Seq("AGTACTGGT", IUPAC.unambiguous_dna)
>>> my_seq
Seq('AGTACTGGT', IUPACUnambiguousDNA())
>>> my_seq.alphabet
IUPACUnambiguousDNA()

```

Unless of course, this really is an amino acid sequence:

```

>>> from Bio.Seq import Seq
>>> from Bio.Alphabet import IUPAC
>>> my_prot = Seq("AGTACTGGT", IUPAC.protein)
>>> my_prot
Seq('AGTACTGGT', IUPACProtein())
>>> my_prot.alphabet
IUPACProtein()

```

3.2 Sequences act like strings

In many ways, we can deal with Seq objects as if they were normal Python strings, for example getting the length, or iterating over the elements:

```

from Bio.Seq import Seq
from Bio.Alphabet import IUPAC
my_seq = Seq("GATCGATGGGCCTATATAGGATCGAAAATCGC", IUPAC.unambiguous_dna)
for index, letter in enumerate(my_seq):
    print index, letter
print len(letter)

```

You can access elements of the sequence in the same way as for strings (but remember, Python counts from zero!):

```

>>> print my_seq[0] #first letter
>>> print my_seq[2] #third letter
>>> print my_seq[-1] #last letter

```

The Seq object has a `.count()` method, just like a string. Note that this means that like a Python string, this gives a *non-overlapping* count:

```

>>> "AAAA".count("AA")
2
>>> Seq("AAAA").count("AA")
2

```

For some biological uses, you may actually want an overlapping count (i.e. 3 in this trivial example). When searching for single letters, this makes no difference:

```
>>> len(my_seq)
32
>>> my_seq.count("G")
10
>>> 100 * float(my_seq.count("G") + my_seq.count("C")) / len(my_seq)
46.875
```

While you could use the above snippet of code to calculate a GC%, note that the `Bio.SeqUtils` module has several GC functions already built. For example:

```
>>> from Bio.Seq import Seq
>>> from Bio.Alphabet import IUPAC
>>> from Bio.SeqUtils import GC
>>> my_seq = Seq('GATCGATGGGCCTATATAGGATCGAAAATCGC', IUPAC.unambiguous_dna)
>>> GC(my_seq)
46.875
```

Note that using the `Bio.SeqUtils.GC()` function should automatically cope with mixed case sequences and the ambiguous nucleotide S which means G or C.

Also note that just like a normal Python string, the `Seq` object is in some ways “read-only”. If you need to edit your sequence, for example simulating a point mutation, look at the Section 3.12 below which talks about the `MutableSeq` object.

3.3 Slicing a sequence

A more complicated example, let’s get a slice of the sequence:

```
>>> from Bio.Seq import Seq
>>> from Bio.Alphabet import IUPAC
>>> my_seq = Seq("GATCGATGGGCCTATATAGGATCGAAAATCGC", IUPAC.unambiguous_dna)
>>> my_seq[4:12]
Seq('GATGGGCC', IUPACUnambiguousDNA())
```

Two things are interesting to note. First, this follows the normal conventions for Python strings. So the first element of the sequence is 0 (which is normal for computer science, but not so normal for biology). When you do a slice the first item is included (i.e. 4 in this case) and the last is excluded (12 in this case), which is the way things work in Python, but of course not necessarily the way everyone in the world would expect. The main goal is to stay consistent with what Python does.

The second thing to notice is that the slice is performed on the sequence data string, but the new object produced is another `Seq` object which retains the alphabet information from the original `Seq` object.

Also like a Python string, you can do slices with a start, stop and *stride* (the step size, which defaults to one). For example, we can get the first, second and third codon positions of this DNA sequence:

```
>>> my_seq[0:3]
Seq('GCTGTAGTAAG', IUPACUnambiguousDNA())
>>> my_seq[1:3]
Seq('AGGCATGCATC', IUPACUnambiguousDNA())
>>> my_seq[2:3]
Seq('TAGCTAAGAC', IUPACUnambiguousDNA())
```

Another stride trick you might have seen with a Python string is the use of a -1 stride to reverse the string. You can do this with a `Seq` object too:

```
>>> my_seq[::-1]
Seq('CGCTAAAAGCTAGGATATATCCGGGTAGCTAG', IUPACUnambiguousDNA())
```

3.4 Turning `Seq` objects into strings

If you really do just need a plain string, for example to write to a file, or insert into a database, then this is very easy to get:

```
>>> str(my_seq)
'GATCGATGGGCCTATATAGGATCGAAAATCGC'
```

Since calling `str()` on a `Seq` object returns the full sequence as a string, you often don't actually have to do this conversion explicitly. Python does this automatically with a print statement:

```
>>> print my_seq
GATCGATGGGCCTATATAGGATCGAAAATCGC
```

You can also use the `Seq` object directly with a `%s` placeholder when using the Python string formatting or interpolation operator (`%`):

```
>>> fasta_format_string = ">Name\n%s\n" % my_seq
>>> print fasta_format_string
>Name
GATCGATGGGCCTATATAGGATCGAAAATCGC
```

This line of code constructs a simple FASTA format record (without worrying about line wrapping). Section 4.5 describes a neat way to get a FASTA formatted string from a `SeqRecord` object, while the more general topic of reading and writing FASTA format sequence files is covered in Chapter 5.

NOTE: If you are using Biopython 1.44 or older, using `str(my_seq)` will give just a truncated representation. Instead use `my_seq.tostring()` (which is still available in the current Biopython releases for backwards compatibility):

```
>>> my_seq.tostring()
'GATCGATGGGCCTATATAGGATCGAAAATCGC'
```

3.5 Concatenating or adding sequences

Naturally, you can in principle add any two `Seq` objects together - just like you can with Python strings to concatenate them. However, you can't add sequences with incompatible alphabets, such as a protein sequence and a DNA sequence:

```
>>> protein_seq + dna_seq
Traceback (most recent call last):
...
TypeError: ('incompatable alphabets', 'IUPACProtein()', 'IUPACUnambiguousDNA()')
```

If you *really* wanted to do this, you'd have to first give both sequences generic alphabets:

```
>>> from Bio.Alphabet import generic_alphabet
>>> protein_seq.alphabet = generic_alphabet
>>> dna_seq.alphabet = generic_alphabet
>>> protein_seq + dna_seq
Seq('EVRNAKACGT', Alphabet())
```

Here is an example of adding a generic nucleotide sequence to an unambiguous IUPAC DNA sequence, resulting in an ambiguous nucleotide sequence:

```
>>> from Bio.Seq import Seq
>>> from Bio.Alphabet import generic_nucleotide
>>> from Bio.Alphabet import IUPAC
>>> nuc_seq = Seq("GATCGATGC", generic_nucleotide)
>>> dna_seq = Seq("ACGT", IUPAC.unambiguous_dna)
>>> nuc_seq
Seq('GATCGATGC', NucleotideAlphabet())
>>> dna_seq
Seq('ACGT', IUPACUnambiguousDNA())
>>> nuc_seq + dna_seq
Seq('GATCGATGCACGT', NucleotideAlphabet())
```

3.6 Changing case

Python strings have very useful `upper` and `lower` methods for changing the case. As of Biopython 1.53, the `Seq` object gained similar methods which are alphabet aware. For example,

```
>>> from Bio.Seq import Seq
>>> from Bio.Alphabet import generic_dna
>>> dna_seq = Seq("acgtACGT", generic_dna)
>>> dna_seq
Seq('acgtACGT', DNAAlphabet())
>>> dna_seq.upper()
Seq('ACGTACGT', DNAAlphabet())
>>> dna_seq.lower()
Seq('acgtacgt', DNAAlphabet())
```

These are useful for doing case insensitive matching:

```
>>> "GTAC" in dna_seq
False
>>> "GTAC" in dna_seq.upper()
True
```

Note that strictly speaking the IUPAC alphabets are for upper case sequences only, thus:

```
>>> from Bio.Seq import Seq
>>> from Bio.Alphabet import IUPAC
>>> dna_seq = Seq("ACGT", IUPAC.unambiguous_dna)
>>> dna_seq
Seq('ACGT', IUPACUnambiguousDNA())
>>> dna_seq.lower()
Seq('acgt', DNAAlphabet())
```

3.7 Nucleotide sequences and (reverse) complements

For nucleotide sequences, you can easily obtain the complement or reverse complement of a `Seq` object using its built-in methods:

```

>>> from Bio.Seq import Seq
>>> from Bio.Alphabet import IUPAC
>>> my_seq = Seq("GATCGATGGGCCTATATAGGATCGAAAATCGC", IUPAC.unambiguous_dna)
>>> my_seq
Seq('GATCGATGGGCCTATATAGGATCGAAAATCGC', IUPACUnambiguousDNA())
>>> my_seq.complement()
Seq('CTAGCTACCCGGATATATCCTAGCTTTTAGCG', IUPACUnambiguousDNA())
>>> my_seq.reverse_complement()
Seq('GCGATTTTCGATCCTATATAGGCCCATCGATC', IUPACUnambiguousDNA())

```

As mentioned earlier, an easy way to just reverse a `Seq` object (or a Python string) is slice it with `-1` step:

```

>>> my_seq[::-1]
Seq('CGCTAAAAGCTAGGATATATCCGGGTAGCTAG', IUPACUnambiguousDNA())

```

In all of these operations, the alphabet property is maintained. This is very useful in case you accidentally end up trying to do something weird like take the (reverse)complement of a protein sequence:

```

>>> from Bio.Seq import Seq
>>> from Bio.Alphabet import IUPAC
>>> protein_seq = Seq("EVRNAK", IUPAC.protein)
>>> protein_seq.complement()
...
ValueError: Proteins do not have complements!

```

The example in Section 5.5.3 combines the `Seq` object's reverse complement method with `Bio.SeqIO` for sequence input/output.

3.8 Transcription

Before talking about transcription, I want to try and clarify the strand issue. Consider the following (made up) stretch of double stranded DNA which encodes a short peptide:

```

      DNA coding strand (aka Crick strand, strand +1)
5'   ATGGCCATTGTAATGGGCCGCTGAAAGGGTGCCCGATAG   3'
      |||
3'   TACCGGTAACATTACCCGGCGACTTCCACGGGCTATC   5'
      DNA template strand (aka Watson strand, strand -1)

```

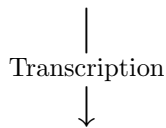

```

5'   AUGGCCAUUGUAAUGGGCCGUGAAAGGGUGCCCGAUAG   3'
      Single stranded messenger RNA

```

The actual biological transcription process works from the template strand, doing a reverse complement (TCAG → CUGA) to give the mRNA. However, in Biopython and bioinformatics in general, we typically work directly with the coding strand because this means we can get the mRNA sequence just by switching T → U.

Now let's actually get down to doing a transcription in Biopython. First, let's create `Seq` objects for the coding and template DNA strands:

```

>>> from Bio.Seq import Seq
>>> from Bio.Alphabet import IUPAC
>>> coding_dna = Seq("ATGGCCATTGTAATGGGCCGCTGAAAGGGTGCCCGATAG", IUPAC.unambiguous_dna)
>>> coding_dna
Seq('ATGGCCATTGTAATGGGCCGCTGAAAGGGTGCCCGATAG', IUPACUnambiguousDNA())
>>> template_dna = coding_dna.reverse_complement()
>>> template_dna
Seq('CTATCGGGCACCCCTTTCAGCGGCCATTACAATGGCCAT', IUPACUnambiguousDNA())

```

These should match the figure above - remember by convention nucleotide sequences are normally read from the 5' to 3' direction, while in the figure the template strand is shown reversed.

Now let's transcribe the coding strand into the corresponding mRNA, using the `Seq` object's built in `transcribe` method:

```

>>> coding_dna
Seq('ATGGCCATTGTAATGGGCCGCTGAAAGGGTGCCCGATAG', IUPACUnambiguousDNA())
>>> messenger_rna = coding_dna.transcribe()
>>> messenger_rna
Seq('AUGGCCAUUGUAAUGGGCCGCUGAAAGGGUGCCCGAUAG', IUPACUnambiguousRNA())

```

As you can see, all this does is switch $T \rightarrow U$, and adjust the alphabet.

If you do want to do a true biological transcription starting with the template strand, then this becomes a two-step process:

```

>>> template_dna.reverse_complement().transcribe()
Seq('AUGGCCAUUGUAAUGGGCCGCUGAAAGGGUGCCCGAUAG', IUPACUnambiguousRNA())

```

The `Seq` object also includes a back-transcription method for going from the mRNA to the coding strand of the DNA. Again, this is a simple $U \rightarrow T$ substitution and associated change of alphabet:

```

>>> from Bio.Seq import Seq
>>> from Bio.Alphabet import IUPAC
>>> messenger_rna = Seq("AUGGCCAUUGUAAUGGGCCGCUGAAAGGGUGCCCGAUAG", IUPAC.unambiguous_rna)
>>> messenger_rna
Seq('AUGGCCAUUGUAAUGGGCCGCUGAAAGGGUGCCCGAUAG', IUPACUnambiguousRNA())
>>> messenger_rna.back_transcribe()
Seq('ATGGCCATTGTAATGGGCCGCTGAAAGGGTGCCCGATAG', IUPACUnambiguousDNA())

```

Note: The `Seq` object's `transcribe` and `back_transcribe` methods were added in Biopython 1.49. For older releases you would have to use the `Bio.Seq` module's functions instead, see Section [3.14](#).

3.9 Translation

Sticking with the same example discussed in the transcription section above, now let's translate this mRNA into the corresponding protein sequence - again taking advantage of one of the `Seq` object's biological methods:

```

>>> from Bio.Seq import Seq
>>> from Bio.Alphabet import IUPAC
>>> messenger_rna = Seq("AUGGCCAUUGUAAUGGGCCGCUGAAAGGGUGCCCGAUAG", IUPAC.unambiguous_rna)
>>> messenger_rna
Seq('AUGGCCAUUGUAAUGGGCCGCUGAAAGGGUGCCCGAUAG', IUPACUnambiguousRNA())
>>> messenger_rna.translate()
Seq('MAIVMGR*KGAR*', HasStopCodon(IUPACProtein(), '*'))

```

You can also translate directly from the coding strand DNA sequence:

```
>>> from Bio.Seq import Seq
>>> from Bio.Alphabet import IUPAC
>>> coding_dna = Seq("ATGGCCATTGTAATGGGCCGCTGAAAGGGTGCCCGATAG", IUPAC.unambiguous_dna)
>>> coding_dna
Seq('ATGGCCATTGTAATGGGCCGCTGAAAGGGTGCCCGATAG', IUPACUnambiguousDNA())
>>> coding_dna.translate()
Seq('MAIVMGR*KGAR*', HasStopCodon(IUPACProtein(), '*'))
```

You should notice in the above protein sequences that in addition to the end stop character, there is an internal stop as well. This was a deliberate choice of example, as it gives an excuse to talk about some optional arguments, including different translation tables (Genetic Codes).

The translation tables available in Biopython are based on those [from the NCBI](#) (see the next section of this tutorial). By default, translation will use the *standard* genetic code (NCBI table id 1). Suppose we are dealing with a mitochondrial sequence. We need to tell the translation function to use the relevant genetic code instead:

```
>>> coding_dna.translate(table="Vertebrate Mitochondrial")
Seq('MAIVMGRWKGAR*', HasStopCodon(IUPACProtein(), '*'))
```

You can also specify the table using the NCBI table number which is shorter, and often included in the feature annotation of GenBank files:

```
>>> coding_dna.translate(table=2)
Seq('MAIVMGRWKGAR*', HasStopCodon(IUPACProtein(), '*'))
```

Now, you may want to translate the nucleotides up to the first in frame stop codon, and then stop (as happens in nature):

```
>>> coding_dna.translate()
Seq('MAIVMGR*KGAR*', HasStopCodon(IUPACProtein(), '*'))
>>> coding_dna.translate(to_stop=True)
Seq('MAIVMGR', IUPACProtein())
>>> coding_dna.translate(table=2)
Seq('MAIVMGRWKGAR*', HasStopCodon(IUPACProtein(), '*'))
>>> coding_dna.translate(table=2, to_stop=True)
Seq('MAIVMGRWKGAR', IUPACProtein())
```

Notice that when you use the `to_stop` argument, the stop codon itself is not translated - and the stop symbol is not included at the end of your protein sequence.

You can even specify the stop symbol if you don't like the default asterisk:

```
>>> coding_dna.translate(table=2, stop_symbol="@")
Seq('MAIVMGRWKGAR@', HasStopCodon(IUPACProtein(), '@'))
```

Now, suppose you have a complete coding sequence CDS, which is to say a nucleotide sequence (e.g. mRNA - after any splicing) which is a whole number of codons (i.e. the length is a multiple of three), commences with a start codon, ends with a stop codon, and has no internal in-frame stop codons. In general, given a complete CDS, the default translate method will do what you want (perhaps with the `to_stop` option). However, what if your sequence uses a non-standard start codon? This happens a lot in bacteria - for example the gene `yaaX` in *E. coli* K12:

```
>>> gene = Seq("GTGAAAAGATGCAATCTATCGTACTCGCACTTTCCTGGTTCTGGTCGCTCCCATGGCA" + \
...           "GCACAGGCTGCGGAAATTACGTTAGTCCCGTCAGTAAAATTACAGATAGGCGATCGTGAT" + \
...           "AATCGTGGCTATTACTGGGATGGAGTCACTGGCGCGACCACGGCTGGTGGAAACAACAT" + \
```

```

...         "TATGAATGGCGAGGCAATCGCTGGCACCTACACGGACCGCCGCCACCGCCGCCACCAT" + \
...         "AAGAAAGCTCCTCATGATCATCACGGCGGTCATGGTCCAGGCAAACATCACCGCTAA",
...         generic_dna)
>>> gene.translate(table="Bacterial")
Seq('VKKMQSIVLALS LVLVAPMAAQAAEITLVPSVKLQIGDRDNRGYYWDGGHWRDH...HR*',
HasStopCodon(ExtendedIUPACProtein(), '*'))
>>> gene.translate(table="Bacterial", to_stop=True)
Seq('VKKMQSIVLALS LVLVAPMAAQAAEITLVPSVKLQIGDRDNRGYYWDGGHWRDH...HHR',
ExtendedIUPACProtein())

```

In the bacterial genetic code **GTG** is a valid start codon, and while it does *normally* encode valine, if used as a start codon it should be translated as methionine. This happens if you tell Biopython your sequence is a complete CDS:

```

>>> gene.translate(table="Bacterial", cds=True)
Seq('MKKMQSIVLALS LVLVAPMAAQAAEITLVPSVKLQIGDRDNRGYYWDGGHWRDH...HHR',
ExtendedIUPACProtein())

```

In addition to telling Biopython to translate an alternative start codon as methionine, using this option also makes sure your sequence really is a valid CDS (you'll get an exception if not).

The example in Section 14.1.2 combines the `Seq` object's `translate` method with `Bio.SeqIO` for sequence input/output.

Note: The `Seq` object's `translate` method is new in Biopython 1.49. For older releases you would have to use the `Bio.Seq` module's `translate` function instead, see Section 3.14. The `cds` option was added in Biopython 1.51, and there is no simple way to do this with older versions of Biopython.

3.10 Translation Tables

In the previous sections we talked about the `Seq` object translation method (and mentioned the equivalent function in the `Bio.Seq` module – see Section 3.14). Internally these use codon table objects derived from the NCBI information at <ftp://ftp.ncbi.nlm.nih.gov/entrez/misc/data/gc.prt>, also shown on <http://www.ncbi.nlm.nih.gov/Taxonomy/Utils/wprintgc.cgi> in a much more readable layout.

As before, let's just focus on two choices: the Standard translation table, and the translation table for Vertebrate Mitochondrial DNA.

```

>>> from Bio.Data import CodonTable
>>> standard_table = CodonTable.unambiguous_dna_by_name["Standard"]
>>> mito_table = CodonTable.unambiguous_dna_by_name["Vertebrate Mitochondrial"]

```

Alternatively, these tables are labeled with ID numbers 1 and 2, respectively:

```

>>> from Bio.Data import CodonTable
>>> standard_table = CodonTable.unambiguous_dna_by_id[1]
>>> mito_table = CodonTable.unambiguous_dna_by_id[2]

```

You can compare the actual tables visually by printing them:

```

>>> print standard_table
Table 1 Standard, SGC0

```

| | T | C | A | G | |
|---|-------|-------|-------|-------|---|
| T | TTT F | TCT S | TAT Y | TGT C | T |

| | | | | | |
|-------|----------|-------|----------|----------|---|
| T | TTC F | TCC S | TAC Y | TGC C | C |
| T | TTA L | TCA S | TAA Stop | TGA Stop | A |
| T | TTG L(s) | TCG S | TAG Stop | TGG W | G |
| ----- | | | | | |
| C | CTT L | CCT P | CAT H | CGT R | T |
| C | CTC L | CCC P | CAC H | CGC R | C |
| C | CTA L | CCA P | CAA Q | CGA R | A |
| C | CTG L(s) | CCG P | CAG Q | CGG R | G |
| ----- | | | | | |
| A | ATT I | ACT T | AAT N | AGT S | T |
| A | ATC I | ACC T | AAC N | AGC S | C |
| A | ATA I | ACA T | AAA K | AGA R | A |
| A | ATG M(s) | ACG T | AAG K | AGG R | G |
| ----- | | | | | |
| G | GTT V | GCT A | GAT D | GGT G | T |
| G | GTC V | GCC A | GAC D | GGC G | C |
| G | GTA V | GCA A | GAA E | GGA G | A |
| G | GTG V | GCG A | GAG E | GGG G | G |
| ----- | | | | | |

and:

```
>>> print mito_table
```

Table 2 Vertebrate Mitochondrial, SGC1

| | T | C | A | G | |
|-------|----------|-------|----------|----------|---|
| ----- | | | | | |
| T | TTT F | TCT S | TAT Y | TGT C | T |
| T | TTC F | TCC S | TAC Y | TGC C | C |
| T | TTA L | TCA S | TAA Stop | TGA W | A |
| T | TTG L | TCG S | TAG Stop | TGG W | G |
| ----- | | | | | |
| C | CTT L | CCT P | CAT H | CGT R | T |
| C | CTC L | CCC P | CAC H | CGC R | C |
| C | CTA L | CCA P | CAA Q | CGA R | A |
| C | CTG L | CCG P | CAG Q | CGG R | G |
| ----- | | | | | |
| A | ATT I(s) | ACT T | AAT N | AGT S | T |
| A | ATC I(s) | ACC T | AAC N | AGC S | C |
| A | ATA M(s) | ACA T | AAA K | AGA Stop | A |
| A | ATG M(s) | ACG T | AAG K | AGG Stop | G |
| ----- | | | | | |
| G | GTT V | GCT A | GAT D | GGT G | T |
| G | GTC V | GCC A | GAC D | GGC G | C |
| G | GTA V | GCA A | GAA E | GGA G | A |
| G | GTG V(s) | GCG A | GAG E | GGG G | G |
| ----- | | | | | |

You may find these following properties useful – for example if you are trying to do your own gene finding:

```
>>> mito_table.stop_codons
['TAA', 'TAG', 'AGA', 'AGG']
>>> mito_table.start_codons
```

```
['ATT', 'ATC', 'ATA', 'ATG', 'GTG']
>>> mito_table.forward_table["ACG"]
'T'
```

3.11 Comparing Seq objects

Sequence comparison is actually a very complicated topic, and there is no easy way to decide if two sequences are equal. The basic problem is the meaning of the letters in a sequence are context dependent - the letter "A" could be part of a DNA, RNA or protein sequence. Biopython uses alphabet objects as part of each `Seq` object to try and capture this information - so comparing two `Seq` objects means considering both the sequence strings *and* the alphabets.

For example, you might argue that the two DNA `Seq` objects `Seq("ACGT", IUPAC.unambiguous_dna)` and `Seq("ACGT", IUPAC.ambiguous_dna)` should be equal, even though they do have different alphabets. Depending on the context this could be important.

This gets worse – suppose you think `Seq("ACGT", IUPAC.unambiguous_dna)` and `Seq("ACGT")` (i.e. the default generic alphabet) should be equal. Then, logically, `Seq("ACGT", IUPAC.protein)` and `Seq("ACGT")` should also be equal. Now, in logic if $A = B$ and $B = C$, by transitivity we expect $A = C$. So for logical consistency we'd require `Seq("ACGT", IUPAC.unambiguous_dna)` and `Seq("ACGT", IUPAC.protein)` to be equal – which most people would agree is just not right. This transitivity problem would also have implications for using `Seq` objects as Python dictionary keys.

So, what does Biopython do? Well, the equality test is the default for Python objects – it tests to see if they are the same object in memory. This is a very strict test:

```
>>> from Bio.Seq import Seq
>>> from Bio.Alphabet import IUPAC
>>> seq1 = Seq("ACGT", IUPAC.unambiguous_dna)
>>> seq2 = Seq("ACGT", IUPAC.unambiguous_dna)
>>> seq1 == seq2
False
>>> seq1 == seq1
True
```

If you actually want to do this, you can be more explicit by using the Python `id` function,

```
>>> id(seq1) == id(seq2)
False
>>> id(seq1) == id(seq1)
True
```

Now, in every day use, your sequences will probably all have the same alphabet, or at least all be the same type of sequence (all DNA, all RNA, or all protein). What you probably want is to just compare the sequences as strings – so do this explicitly:

```
>>> str(seq1) == str(seq2)
True
>>> str(seq1) == str(seq1)
True
```

As an extension to this, while you can use a Python dictionary with `Seq` objects as keys, it is generally more useful to use the sequence a string for the key. See also Section [3.4](#).

3.12 MutableSeq objects

Just like the normal Python string, the `Seq` object is “read only”, or in Python terminology, immutable. Apart from wanting the `Seq` object to act like a string, this is also a useful default since in many biological applications you want to ensure you are not changing your sequence data:

```
>>> from Bio.Seq import Seq
>>> from Bio.Alphabet import IUPAC
>>> my_seq = Seq("GCCATTGTAATGGGCCGCTGAAAGGGTGCCCGA", IUPAC.unambiguous_dna)
>>> my_seq[5] = "G"
Traceback (most recent call last):
  File "<stdin>", line 1, in ?
AttributeError: 'Seq' instance has no attribute '__setitem__'
```

However, you can convert it into a mutable sequence (a `MutableSeq` object) and do pretty much anything you want with it:

```
>>> mutable_seq = my_seq.tomutable()
>>> mutable_seq
MutableSeq('GCCATTGTAATGGGCCGCTGAAAGGGTGCCCGA', IUPACUnambiguousDNA())
```

Alternatively, you can create a `MutableSeq` object directly from a string:

```
>>> from Bio.Seq import MutableSeq
>>> from Bio.Alphabet import IUPAC
>>> mutable_seq = MutableSeq("GCCATTGTAATGGGCCGCTGAAAGGGTGCCCGA", IUPAC.unambiguous_dna)
```

Either way will give you a sequence object which can be changed:

```
>>> mutable_seq
MutableSeq('GCCATTGTAATGGGCCGCTGAAAGGGTGCCCGA', IUPACUnambiguousDNA())
>>> mutable_seq[5] = "T"
>>> mutable_seq
MutableSeq('GCCATTGTAATGGGCCGCTGAAAGGGTGCCCGA', IUPACUnambiguousDNA())
>>> mutable_seq.remove("T")
>>> mutable_seq
MutableSeq('GCCATGTAATGGGCCGCTGAAAGGGTGCCCGA', IUPACUnambiguousDNA())
>>> mutable_seq.reverse()
>>> mutable_seq
MutableSeq('AGCCCGTGGGAAAGTCGCCGGTAATGTACCG', IUPACUnambiguousDNA())
```

Do note that unlike the `Seq` object, the `MutableSeq` object’s methods like `reverse_complement()` and `reverse()` act in-situ!

An important technical difference between mutable and immutable objects in Python means that you can’t use a `MutableSeq` object as a dictionary key, but you can use a Python string or a `Seq` object in this way.

Once you have finished editing your a `MutableSeq` object, it’s easy to get back to a read-only `Seq` object should you need to:

```
>>> new_seq = mutable_seq.toseq()
>>> new_seq
Seq('AGCCCGTGGGAAAGTCGCCGGTAATGTACCG', IUPACUnambiguousDNA())
```

You can also get a string from a `MutableSeq` object just like from a `Seq` object (Section 3.4).

3.13 UnknownSeq objects

Biopython 1.50 introduced another basic sequence object, the `UnknownSeq` object. This is a subclass of the basic `Seq` object and its purpose is to represent a sequence where we know the length, but not the actual letters making it up. You could of course use a normal `Seq` object in this situation, but it wastes rather a lot of memory to hold a string of a million “N” characters when you could just store a single letter “N” and the desired length as an integer.

```
>>> from Bio.Seq import UnknownSeq
>>> unk = UnknownSeq(20)
>>> unk
UnknownSeq(20, alphabet = Alphabet(), character = '?')
>>> print unk
????????????????????
>>> len(unk)
20
```

You can of course specify an alphabet, meaning for nucleotide sequences the letter defaults to “N” and for proteins “X”, rather than just “?”.

```
>>> from Bio.Seq import UnknownSeq
>>> from Bio.Alphabet import IUPAC
>>> unk_dna = UnknownSeq(20, alphabet=IUPAC.ambiguous_dna)
>>> unk_dna
UnknownSeq(20, alphabet = IUPACAmbiguousDNA(), character = 'N')
>>> print unk_dna
NNNNNNNNNNNNNNNNNNNN
```

You can use all the usual `Seq` object methods too, note these give back memory saving `UnknownSeq` objects where appropriate as you might expect:

```
>>> unk_dna
UnknownSeq(20, alphabet = IUPACAmbiguousDNA(), character = 'N')
>>> unk_dna.complement()
UnknownSeq(20, alphabet = IUPACAmbiguousDNA(), character = 'N')
>>> unk_dna.reverse_complement()
UnknownSeq(20, alphabet = IUPACAmbiguousDNA(), character = 'N')
>>> unk_dna.transcribe()
UnknownSeq(20, alphabet = IUPACAmbiguousRNA(), character = 'N')
>>> unk_protein = unk_dna.translate()
>>> unk_protein
UnknownSeq(6, alphabet = ProteinAlphabet(), character = 'X')
>>> print unk_protein
XXXXXX
>>> len(unk_protein)
6
```

You may be able to find a use for the `UnknownSeq` object in your own code, but it is more likely that you will first come across them in a `SeqRecord` object created by `Bio.SeqIO` (see Chapter 5). Some sequence file formats don’t always include the actual sequence, for example GenBank and EMBL files may include a list of features but for the sequence just present the contig information. Alternatively, the QUAL files used in sequencing work hold quality scores but they *never* contain a sequence – instead there is a partner FASTA file which *does* have the sequence.

3.14 Working with directly strings

To close this chapter, for those you who *really* don't want to use the sequence objects (or who prefer a functional programming style to an object orientated one), there are module level functions in `Bio.Seq` will accept plain Python strings, `Seq` objects (including `UnknownSeq` objects) or `MutableSeq` objects:

```
>>> from Bio.Seq import reverse_complement, transcribe, back_transcribe, translate
>>> my_string = "GCTGTTATGGGTCGTTGGAAGGGTGGTCGTGCTGCTGGTTAG"
>>> reverse_complement(my_string)
'CTAACCAGCAGCAGACCACCCTTCCAACGACCCATAACAGC'
>>> transcribe(my_string)
'GCUGUUAUGGGUCGUUGGAAGGGUGGUCGUGCUGCUGGUUAG'
>>> back_transcribe(my_string)
'GCTGTTATGGGTCGTTGGAAGGGTGGTCGTGCTGCTGGTTAG'
>>> translate(my_string)
'AVMGRWKGGRAAG*'

```

You are, however, encouraged to work with `Seq` objects by default.

Chapter 4

Sequence Record objects

Chapter 3 introduced the sequence classes. Immediately “above” the `Seq` class is the Sequence Record or `SeqRecord` class, defined in the `Bio.SeqRecord` module. This class allows higher level features such as identifiers and features to be associated with the sequence, and is used throughout the sequence input/output interface `Bio.SeqIO` described fully in Chapter 5.

If you are only going to be working with simple data like FASTA files, you can probably skip this chapter for now. If on the other hand you are going to be using richly annotated sequence data, say from GenBank or EMBL files, this information is quite important.

While this chapter should cover most things to do with the `SeqRecord` object in this chapter, you may also want to read the `SeqRecord` wiki page (<http://biopython.org/wiki/SeqRecord>), and the built in documentation (also [online](#)):

```
>>> from Bio.SeqRecord import SeqRecord
>>> help(SeqRecord)
...
```

4.1 The `SeqRecord` object

The `SeqRecord` (Sequence Record) class is defined in the `Bio.SeqRecord` module. This class allows higher level features such as identifiers and features to be associated with a sequence (see Chapter 3), and is the basic data type for the `Bio.SeqIO` sequence input/output interface (see Chapter 5).

The `SeqRecord` class itself is quite simple, and offers the following information as attributes:

seq – The sequence itself, typically a `Seq` object.

id – The primary ID used to identify the sequence – a string. In most cases this is something like an accession number.

name – A “common” name/id for the sequence – a string. In some cases this will be the same as the accession number, but it could also be a clone name. I think of this as being analagous to the LOCUS id in a GenBank record.

description – A human readable description or expressive name for the sequence – a string.

letter_annotations – Holds per-letter-annotations using a (restricted) dictionary of additional information about the letters in the sequence. The keys are the name of the information, and the information is contained in the value as a Python sequence (i.e. a list, tuple or string) with the same length as the sequence itself. This is often used for quality scores (e.g. Section 14.1.4) or secondary structure information (e.g. from Stockholm/PFAM alignment files).

annotations – A dictionary of additional information about the sequence. The keys are the name of the information, and the information is contained in the value. This allows the addition of more “unstructured” information to the sequence.

features – A list of `SeqFeature` objects with more structured information about the features on a sequence (e.g. position of genes on a genome, or domains on a protein sequence). The structure of sequence features is described below in Section 4.3.

dbxrefs – A list of database cross-references as strings.

4.2 Creating a `SeqRecord`

Using a `SeqRecord` object is not very complicated, since all of the information is presented as attributes of the class. Usually you won’t create a `SeqRecord` “by hand”, but instead use `Bio.SeqIO` to read in a sequence file for you (see Chapter 5 and the examples below). However, creating `SeqRecord` can be quite simple.

4.2.1 `SeqRecord` objects from scratch

To create a `SeqRecord` at a minimum you just need a `Seq` object:

```
>>> from Bio.Seq import Seq
>>> simple_seq = Seq("GATC")
>>> from Bio.SeqRecord import SeqRecord
>>> simple_seq_r = SeqRecord(simple_seq)
```

Additionally, you can also pass the id, name and description to the initialization function, but if not they will be set as strings indicating they are unknown, and can be modified subsequently:

```
>>> simple_seq_r.id
'<unknown id>'
>>> simple_seq_r.id = "AC12345"
>>> simple_seq_r.description = "Made up sequence I wish I could write a paper about"
>>> print simple_seq_r.description
Made up sequence I wish I could write a paper about
>>> simple_seq_r.seq
Seq('GATC', Alphabet())
```

Including an identifier is very important if you want to output your `SeqRecord` to a file. You would normally include this when creating the object:

```
>>> from Bio.Seq import Seq
>>> simple_seq = Seq("GATC")
>>> from Bio.SeqRecord import SeqRecord
>>> simple_seq_r = SeqRecord(simple_seq, id="AC12345")
```

As mentioned above, the `SeqRecord` has an dictionary attribute `annotations`. This is used for any miscellaneous annotations that doesn’t fit under one of the other more specific attributes. Adding annotations is easy, and just involves dealing directly with the annotation dictionary:

```
>>> simple_seq_r.annotations["evidence"] = "None. I just made it up."
>>> print simple_seq_r.annotations
{'evidence': 'None. I just made it up.'}
>>> print simple_seq_r.annotations["evidence"]
None. I just made it up.
```

Working with per-letter-annotations is similar, `letter_annotations` is a dictionary like attribute which will let you assign any Python sequence (i.e. a string, list or tuple) which has the same length as the sequence:

```
>>> simple_seq_r.letter_annotations["phred_quality"] = [40,40,38,30]
>>> print simple_seq_r. letter_annotations
{'phred_quality': [40, 40, 38, 30]}
>>> print simple_seq_r.letter_annotations["phred_quality"]
[40, 40, 38, 30]
```

The `dbxrefs` and `features` attributes are just Python lists, and should be used to store strings and `SeqFeature` objects (discussed later in this chapter) respectively.

4.2.2 SeqRecord objects from FASTA files

This example uses a fairly large FASTA file containing the whole sequence for *Yersinia pestis biovar Microtus* str. 91001 plasmid pPCP1, originally downloaded from the NCBI. This file is included with the Biopython unit tests under the GenBank folder, or online [NC_005816.fna](#) from our website.

The file starts like this - and you can check there is only one record present (i.e. only one line starting with a greater than symbol):

```
>gi|45478711|ref|NC_005816.1| Yersinia pestis biovar Microtus ... pPCP1, complete sequence
TGTAACGAACGGTGCAATAGTGATCCACACCCAACGCCTGAAATCAGATCCAGGGGTAATCTGCTCTCC
...
```

Back in Chapter 2 you will have seen the function `Bio.SeqIO.parse(...)` used to loop over all the records in a file as `SeqRecord` objects. The `Bio.SeqIO` module has a sister function for use on files which contain just one record which we'll use here (see Chapter 5 for details):

```
>>> from Bio import SeqIO
>>> record = SeqIO.read("NC_005816.fna", "fasta")
>>> record
SeqRecord(seq=Seq('TGTAACGAACGGTGCAATAGTGATCCACACCCAACGCCTGAAATCAGATCCAGG...CTG',
SingleLetterAlphabet()), id='gi|45478711|ref|NC_005816.1|', name='gi|45478711|ref|NC_005816.1|',
description='gi|45478711|ref|NC_005816.1| Yersinia pestis biovar Microtus ... sequence',
dbxrefs=[])
```

Now, let's have a look at the key attributes of this `SeqRecord` individually - starting with the `seq` attribute which gives you a `Seq` object:

```
>>> record.seq
Seq('TGTAACGAACGGTGCAATAGTGATCCACACCCAACGCCTGAAATCAGATCCAGG...CTG', SingleLetterAlphabet())
```

Here `Bio.SeqIO` has defaulted to a generic alphabet, rather than guessing that this is DNA. If you know in advance what kind of sequence your FASTA file contains, you can tell `Bio.SeqIO` which alphabet to use (see Chapter 5).

Next, the identifiers and description:

```
>>> record.id
'gi|45478711|ref|NC_005816.1|'
>>> record.name
'gi|45478711|ref|NC_005816.1|'
>>> record.description
'gi|45478711|ref|NC_005816.1| Yersinia pestis biovar Microtus ... pPCP1, complete sequence'
```

As you can see above, the first word of the FASTA record's title line (after removing the greater than symbol) is used for both the `id` and `name` attributes. The whole title line (after removing the greater than symbol) is used for the record description. This is deliberate, partly for backwards compatibility reasons, but it also makes sense if you have a FASTA file like this:

```
>Yersinia pestis biovar Microtus str. 91001 plasmid pPCP1
TGTAACGAACGGTGCAATAGTGATCCACACCCAACGCCTGAAATCAGATCCAGGGGTAATCTGCTCTCC
...
```

Note that none of the other annotation attributes get populated when reading a FASTA file:

```
>>> record.dbxrefs
[]
>>> record.annotations
{}
>>> record.letter_annotations
{}
>>> record.features
[]
```

In this case our example FASTA file was from the NCBI, and they have a fairly well defined set of conventions for formatting their FASTA lines. This means it would be possible to parse this information and extract the GI number and accession for example. However, FASTA files from other sources vary, so this isn't possible in general.

4.2.3 SeqRecord objects from GenBank files

As in the previous example, we're going to look at the whole sequence for *Yersinia pestis biovar Microtus* str. 91001 plasmid pPCP1, originally downloaded from the NCBI, but this time as a GenBank file. Again, this file is included with the Biopython unit tests under the GenBank folder, or online [NC_005816.gb](#) from our website.

This file contains a single record (i.e. only one LOCUS line) and starts:

```
LOCUS      NC_005816                9609 bp    DNA     circular BCT 21-JUL-2008
DEFINITION Yersinia pestis biovar Microtus str. 91001 plasmid pPCP1, complete
           sequence.
ACCESSION  NC_005816
VERSION    NC_005816.1  GI:45478711
PROJECT    GenomeProject:10638
...
```

Again, we'll use `Bio.SeqIO` to read this file in, and the code is almost identical to that for used above for the FASTA file (see Chapter 5 for details):

```
>>> from Bio import SeqIO
>>> record = SeqIO.read("NC_005816.gb", "genbank")
>>> record
SeqRecord(seq=Seq('TGTAACGAACGGTGCAATAGTGATCCACACCCAACGCCTGAAATCAGATCCAGG...CTG',
IUPACAmbiguousDNA()), id='NC_005816.1', name='NC_005816',
description='Yersinia pestis biovar Microtus str. 91001 plasmid pPCP1, complete sequence.',
dbxrefs=['Project:10638'])
```

You should be able to spot some differences already! But taking the attributes individually, the sequence string is the same as before, but this time `Bio.SeqIO` has been able to automatically assign a more specific alphabet (see Chapter 5 for details):

```
>>> record.seq
Seq('TGTAACGAACGGTGC AATAGTGATCCACACCCAACGCCTGAAATCAGATCCAGG...CTG', IUPACAmbiguousDNA())
```

The `name` comes from the LOCUS line, while the `id` includes the version suffix. The description comes from the DEFINITION line:

```
>>> record.id
'NC_005816.1'
>>> record.name
'NC_005816'
>>> record.description
'Yersinia pestis biovar Microtus str. 91001 plasmid pPCP1, complete sequence.'
```

GenBank files don't have any per-letter annotations:

```
>>> record.letter_annotations
{}
```

Most of the annotations information gets recorded in the `annotations` dictionary, for example:

```
>>> len(record.annotations)
11
>>> record.annotations["source"]
'Yersinia pestis biovar Microtus str. 91001'
```

The `dbxrefs` list gets populated from any PROJECT or DBLINK lines:

```
>>> record.dbxrefs
['Project:10638']
```

Finally, and perhaps most interestingly, all the entries in the features table (e.g. the genes or CDS features) get recorded as `SeqFeature` objects in the `features` list.

```
>>> len(record.features)
29
```

We'll talk about `SeqFeature` objects next, in [Section 4.3](#).

4.3 SeqFeature objects

Sequence features are an essential part of describing a sequence. Once you get beyond the sequence itself, you need some way to organize and easily get at the more “abstract” information that is known about the sequence. While it is probably impossible to develop a general sequence feature class that will cover everything, the Biopython `SeqFeature` class attempts to encapsulate as much of the information about the sequence as possible. The design is heavily based on the GenBank/EMBL feature tables, so if you understand how they look, you'll probably have an easier time grasping the structure of the Biopython classes.

4.3.1 SeqFeatures themselves

The first level of dealing with sequence features is the `SeqFeature` class itself. This class has a number of attributes, so first we'll list them and their general features, and then work through an example to show how this applies to a real life example, a GenBank feature table. The attributes of a `SeqFeature` are:

location – The location of the `SeqFeature` on the sequence that you are dealing with. The locations end-points may be fuzzy – section 4.3.2 has a lot more description on how to deal with descriptions.

type – This is a textual description of the type of feature (for instance, this will be something like ‘CDS’ or ‘gene’).

ref – A reference to a different sequence. Some times features may be “on” a particular sequence, but may need to refer to a different sequence, and this provides the reference (normally an accession number). A good example of this is a genomic sequence that has most of a coding sequence, but one of the exons is on a different accession. In this case, the feature would need to refer to this different accession for this missing exon. You are most likely to see this in contig GenBank files.

ref_db – This works along with `ref` to provide a cross sequence reference. If there is a reference, `ref_db` will be set as `None` if the reference is in the same database, and will be set to the name of the database otherwise.

strand – The strand on the sequence that the feature is located on. This may either be 1 for the top strand, -1 for the bottom strand, or 0 or `None` for both strands (or if it doesn’t matter). Keep in mind that this only really makes sense for double stranded DNA, and not for proteins or RNA.

qualifiers – This is a Python dictionary of additional information about the feature. The key is some kind of terse one-word description of what the information contained in the value is about, and the value is the actual information. For example, a common key for a qualifier might be “evidence” and the value might be “computational (non-experimental).” This is just a way to let the person who is looking at the feature know that it has not be experimentally (i. e. in a wet lab) confirmed. Note that other the value will be a list of strings (even when there is only one string). This is a reflection of the feature tables in GenBank/EMBL files.

sub_features – A very important feature of a feature is that it can have additional `sub_features` underneath it. This allows nesting of features, and helps us to deal with things such as the GenBank/EMBL feature lines in a (we hope) intuitive way.

To show an example of `SeqFeatures` in action, let’s take a look at the following feature from a GenBank feature table:

```
mRNA          complement(join(<49223..49300,49780..>50208))
              /gene="F28B23.12"
```

To look at the easiest attributes of the `SeqFeature` first, if you got a `SeqFeature` object for this it would have its `type` of ‘mRNA’, a `strand` of -1 (due to the ‘complement’), and would have `None` for the `ref` and `ref_db` since there are no references to external databases. The `qualifiers` for this `SeqFeature` would be a Python dictionary that looked like `{‘gene’ : [‘F28B23.12’]}`.

Now let’s look at the more tricky part, how the ‘join’ in the location line is handled. First, the location for the top level `SeqFeature` (the one we are dealing with right now) is set as going from ‘<49223’ to ‘>50208’ (see section 4.3.2 for the nitty gritty on how fuzzy locations like this are handled). So the location of the top level object is the entire span of the feature. So, how do you get at the information in the ‘join’? Well, that’s where the `sub_features` go in.

The `sub_features` attribute will have a list with two `SeqFeature` objects in it, and these contain the information in the join. Let’s look at `top_level_feature.sub_features[0]` (the first `sub_feature`). This object is a `SeqFeature` object with a `type` of ‘mRNA,’ a `strand` of -1 (inherited from the parent `SeqFeature`) and a location going from ‘<49223’ to ‘>49300’.

So, the `sub_features` allow you to get at the internal information if you want it (i. e. if you were trying to get only the exons out of a genomic sequence), or just to deal with the broad picture (i. e. you just want to know that the coding sequence for a gene lies in a region). Hopefully this structuring makes it easy and intuitive to get at the sometimes complex information that can be contained in a `SeqFeature`.

4.3.2 Locations

In the section on SeqFeatures above, we skipped over one of the more difficult parts of features, dealing with the locations. The reason this can be difficult is because of fuzziness of the positions in locations. Before we get into all of this, let's just define the vocabulary we'll use to talk about this. Basically there are two terms we'll use:

position – This refers to a single position on a sequence, which may be fuzzy or not. For instance, 5, 20, <100 and 3^5 are all positions.

location – A location is two positions that defines a region of a sequence. For instance 5..20 (i. e. 5 to 20) is a location.

I just mention this because sometimes I get confused between the two.

The complication in dealing with locations comes in the positions themselves. In biology many times things aren't entirely certain (as much as us wet lab biologists try to make them certain!). For instance, you might do a dinucleotide priming experiment and discover that the start of mRNA transcript starts at one of two sites. This is very useful information, but the complication comes in how to represent this as a position. To help us deal with this, we have the concept of fuzzy positions. Basically there are five types of fuzzy positions, so we have five classes to deal with them:

ExactPosition – As its name suggests, this class represents a position which is specified as exact along the sequence. This is represented as just a a number, and you can get the position by looking at the `position` attribute of the object.

BeforePosition – This class represents a fuzzy position that occurs prior to some specified site. In GenBank/EMBL notation, this is represented as something like '<13', signifying that the real position is located somewhere less than 13. To get the specified upper boundary, look at the `position` attribute of the object.

AfterPosition – Contrary to **BeforePosition**, this class represents a position that occurs after some specified site. This is represented in GenBank as '>13', and like **BeforePosition**, you get the boundary number by looking at the `position` attribute of the object.

WithinPosition – This class models a position which occurs somewhere between two specified nucleotides. In GenBank/EMBL notation, this would be represented as '(1.5)', to represent that the position is somewhere within the range 1 to 5. To get the information in this class you have to look at two attributes. The `position` attribute specifies the lower boundary of the range we are looking at, so in our example case this would be one. The `extension` attribute specifies the range to the higher boundary, so in this case it would be 4. So `object.position` is the lower boundary and `object.position + object.extension` is the upper boundary.

BetweenPosition – This class deals with a position that occurs between two coordinates. For instance, you might have a protein binding site that occurs between two nucleotides on a sequence. This is represented as '2^3', which indicates that the real position happens between position 2 and 3. Getting this information from the object is very similar to **WithinPosition**, the `position` attribute specifies the lower boundary (2, in this case) and the `extension` indicates the range to the higher boundary (1 in this case).

Now that we've got all of the types of fuzzy positions we can have taken care of, we are ready to actually specify a location on a sequence. This is handled by the **FeatureLocation** class. An object of this type basically just holds the potentially fuzzy start and end positions of a feature. You can create a **FeatureLocation** object by creating the positions and passing them in:

```

>>> from Bio import SeqFeature
>>> start_pos = SeqFeature.AfterPosition(5)
>>> end_pos = SeqFeature.BetweenPosition(8, 1)
>>> my_location = SeqFeature.FeatureLocation(start_pos, end_pos)

```

If you print out a `FeatureLocation` object, you can get a nice representation of the information:

```

>>> print my_location
[>5:(8^9)]

```

We can access the fuzzy start and end positions using the `start` and `end` attributes of the location:

```

>>> my_location.start
Bio.SeqFeature.AfterPosition(5)
>>> print my_location.start
>5
>>> my_location.end
Bio.SeqFeature.BetweenPosition(8,1)
>>> print my_location.end
(8^9)

```

If you don't want to deal with fuzzy positions and just want numbers, you just need to ask for the `nofuzzy_start` and `nofuzzy_end` attributes of the location:

```

>>> my_location.nofuzzy_start
5
>>> my_location.nofuzzy_end
8

```

Notice that this just gives you back the position attributes of the fuzzy locations.

Similarly, to make it easy to create a position without worrying about fuzzy positions, you can just pass in numbers to the `FeaturePosition` constructors, and you'll get back out `ExactPosition` objects:

```

>>> exact_location = SeqFeature.FeatureLocation(5, 8)
>>> print exact_location
[5:8]
>>> exact_location.start
Bio.SeqFeature.ExactPosition(5)
>>> exact_location.nofuzzy_start
5

```

That is all of the nitty gritty about dealing with fuzzy positions in Biopython. It has been designed so that dealing with fuzziness is not that much more complicated than dealing with exact positions, and hopefully you find that true!

4.4 References

Another common annotation related to a sequence is a reference to a journal or other published work dealing with the sequence. We have a fairly simple way of representing a Reference in Biopython – we have a `Bio.SeqFeature.Reference` class that stores the relevant information about a reference as attributes of an object.

The attributes include things that you would expect to see in a reference like `journal`, `title` and `authors`. Additionally, it also can hold the `medline_id` and `pubmed_id` and a `comment` about the reference. These are all accessed simply as attributes of the object.

A reference also has a `location` object so that it can specify a particular location on the sequence that the reference refers to. For instance, you might have a journal that is dealing with a particular gene located on a BAC, and want to specify that it only refers to this position exactly. The `location` is a potentially fuzzy location, as described in section 4.3.2.

Any reference objects are stored as a list in the `SeqRecord` object's `annotations` dictionary under the key "references". That's all there is too it. References are meant to be easy to deal with, and hopefully general enough to cover lots of usage cases.

4.5 The format method

Biopython 1.48 added a new `format()` method to the `SeqRecord` class which gives a string containing your record formatted using one of the output file formats supported by `Bio.SeqIO`, such as FASTA:

```
from Bio.Seq import Seq
from Bio.SeqRecord import SeqRecord
from Bio.Alphabet import generic_protein

record = SeqRecord(Seq("MMYQQGCFAGGTVLRLAKDLAENNRGARVLVVCSEITAVTFRGPPSETHLDSMVGQALFGD" \
    +"GAGAVIVGSDPDLSEVERPLYELVWTGATLLPDSEGAIDGHLREVGLTFHLLKDVPGLISK" \
    +"NIEKSLKEAFTPLGISDWNSTFWIAHPGGPAILDQVEAKLGLKEEKMRAATREVLSEYGNM" \
    +"SSAC", generic_protein),
    id="gi|14150838|gb|AAK54648.1|AF376133_1",
    description="chalcone synthase [Cucumis sativus]")

print record.format("fasta")
```

which should give:

```
>gi|14150838|gb|AAK54648.1|AF376133_1 chalcone synthase [Cucumis sativus]
MMYQQGCFAGGTVLRLAKDLAENNRGARVLVVCSEITAVTFRGPPSETHLDSMVGQALFGD
GAGAVIVGSDPDLSEVERPLYELVWTGATLLPDSEGAIDGHLREVGLTFHLLKDVPGLISK
NIEKSLKEAFTPLGISDWNSTFWIAHPGGPAILDQVEAKLGLKEEKMRAATREVLSEYGNM
SSAC
```

This `format` method takes a single mandatory argument, a lower case string which is supported by `Bio.SeqIO` as an output format (see Chapter 5). However, some of the file formats `Bio.SeqIO` can write to *require* more than one record (typically the case for multiple sequence alignment formats), and thus won't work via this `format()` method. See also Section 5.5.4.

4.6 Slicing a SeqRecord

One of the new features in Biopython 1.50 was the ability to slice a `SeqRecord`, to give you a new `SeqRecord` covering just part of the sequence. What is important here is that any per-letter annotations are also sliced, and any features which fall completely within the new sequence are preserved (with their locations adjusted).

For example, taking the same GenBank file used earlier:

```
>>> from Bio import SeqIO
>>> record = SeqIO.read("NC_005816.gb", "genbank")
>>> record
SeqRecord(seq=Seq('TGTAACGAACGGTGCAATAGTGATCCACACCCAACGCCTGAAATCAGATCCAGG...CTG',
IUPACAmbiguousDNA()), id='NC_005816.1', name='NC_005816',
description='Yersinia pestis biovar Microtus str. 91001 plasmid pPCP1, complete sequence.',
```



```

dbxrefs=['Project:10638'])
>>> len(record)
9609
>>> len(record.features)
29

```

For this example we're going to focus in on the `pim` gene, `YP_pPCP05`. If you have a look at the GenBank file directly you'll find this gene/CDS has location string `4343..4780`, or in Python counting `4342:4780`. From looking at the file you can work out that these are the twelfth and thirteenth entries in the file, so in Python zero-based counting they are entries 11 and 12 in the `features` list:

```

>>> print record.features[11]
type: gene
location: [4342:4780]
ref: None:None
strand: 1
qualifiers:
  Key: db_xref, Value: ['GeneID:2767712']
  Key: gene, Value: ['pim']
  Key: locus_tag, Value: ['YP_pPCP05']

>>> print record.features[12]
type: CDS
location: [4342:4780]
ref: None:None
strand: 1
qualifiers:
  Key: codon_start, Value: ['1']
  Key: db_xref, Value: ['GI:45478716', 'GeneID:2767712']
  Key: gene, Value: ['pim']
  Key: locus_tag, Value: ['YP_pPCP05']
  Key: note, Value: ['similar to many previously sequenced pesticin immunity ...']
  Key: product, Value: ['pesticin immunity protein']
  Key: protein_id, Value: ['NP_995571.1']
  Key: transl_table, Value: ['11']
  Key: translation, Value: ['MGGGMISKLFCLALIFLSSSGLAEKNTYTAKDILQNLLENTFGNSLSH...']

```

Let's slice this parent record from 4300 to 4800 (enough to include the `pim` gene/CDS), and see how many features we get:

```

>>> sub_record = record[4300:4800]
>>> sub_record
SeqRecord(seq=Seq('ATAAATAGATTATTCCAAATAATTTATTTATGTAAGAACAGGATGGGAGGGGGA...TTA',
IUPACAmbiguousDNA()), id='NC_005816.1', name='NC_005816',
description='Yersinia pestis biovar Microtus str. 91001 plasmid pPCP1, complete sequence.',
dbxrefs=[])
>>> len(sub_record)
500
>>> len(sub_record.features)
2

```

Our sub-record just has two features, the gene and CDS entries for `YP_pPCP05`:

```

>>> print sub_record.features[0]
type: gene
location: [42:480]
ref: None:None
strand: 1
qualifiers:
  Key: db_xref, Value: ['GeneID:2767712']
  Key: gene, Value: ['pim']
  Key: locus_tag, Value: ['YP_pPCP05']

>>> print sub_record.features[1]
type: CDS
location: [42:480]
ref: None:None
strand: 1
qualifiers:
  Key: codon_start, Value: ['1']
  Key: db_xref, Value: ['GI:45478716', 'GeneID:2767712']
  Key: gene, Value: ['pim']
  Key: locus_tag, Value: ['YP_pPCP05']
  Key: note, Value: ['similar to many previously sequenced pesticin immunity ...']
  Key: product, Value: ['pesticin immunity protein']
  Key: protein_id, Value: ['NP_995571.1']
  Key: transl_table, Value: ['11']
  Key: translation, Value: ['MGGGMISKLFCLALIFLSSSGLAEKNTYTAKDILQNLELNTFGNSLSH...']

```

Notice that their locations have been adjusted to reflect the new parent sequence!

While Biopython has done something sensible and hopefully intuitive with the features (and any per-letter annotation), for the other annotation it is impossible to know if this still applies to the sub-sequence or not. To avoid guessing, the `annotations` and `dbxrefs` are omitted from the sub-record, and it is up to you to transfer any relevant information as appropriate.

```

>>> sub_record.annotations
{}
>>> sub_record.dbxrefs
[]

```

The same point could be made about the record `id`, `name` and `description`, but for practicality these are preserved:

```

>>> sub_record.id
'NC_005816.1'
>>> sub_record.name
'NC_005816'
>>> sub_record.description
'Yersinia pestis biovar Microtus str. 91001 plasmid pPCP1, complete sequence.'

```

This illustrates the problem nicely though, our new sub-record is *not* the complete sequence of the plasmid, so the description is wrong! Let's fix this and then view the sub-record as a reduced GenBank file using the `format` method described above in Section 4.5:

```

>>> sub_record.description = "Yersinia pestis biovar Microtus str. 91001 plasmid pPCP1, partial."
>>> print sub_record.format("genbank")
...

```

See Sections 14.1.5 and 14.1.6 for some FASTQ examples where the per-letter annotations (the read quality scores) are also sliced.

4.7 Adding SeqRecord objects

One of the new features in Biopython 1.53 was the ability to add `SeqRecord` objects together, giving a new `SeqRecord`. What is important here is that any common per-letter annotations are also added, all the features are preserved (with their locations adjusted), and any other common annotation is also kept (like the id, name and description).

For an example with per-letter annotation, we'll use the first record in a FASTQ file. Chapter 5 will explain the `SeqIO` functions:

```
>>> from Bio import SeqIO
>>> record = SeqIO.parse("example.fastq", "fastq").next()
>>> len(record)
25
>>> print record.seq
CCCTTCTTGTCTTCAGCGTTCTCC
>>> print record.letter_annotations["phred_quality"]
[26, 26, 18, 26, 26, 26, 26, 26, 26, 26, 26, 26, 26, 26, 22, 26, 26, 26, 26,
26, 26, 26, 23, 23]
```

Let's suppose this was Roche 454 data, and that from other information you think the TTT should be only TT. We can make a new edited record by first slicing the `SeqRecord` before and after the "extra" third T:

```
>>> left = record[:20]
>>> print left.seq
CCCTTCTTGTCTTCAGCGTT
>>> print left.letter_annotations["phred_quality"]
[26, 26, 18, 26, 26, 26, 26, 26, 26, 26, 26, 26, 26, 26, 26, 22, 26, 26, 26, 26]
>>> right = record[21:]
>>> print right.seq
CTCC
>>> print right.letter_annotations["phred_quality"]
[26, 26, 23, 23]
```

Now add the two parts together:

```
>>> edited = left + right
>>> len(edited)
24
>>> print edited.seq
CCCTTCTTGTCTTCAGCGTTCTCC
>>> print edited.letter_annotations["phred_quality"]
[26, 26, 18, 26, 26, 26, 26, 26, 26, 26, 26, 26, 26, 26, 26, 22, 26, 26, 26, 26,
26, 26, 23, 23]
```

Easy and intuitive? We hope so! You can make this shorter with just:

```
>>> edited = record[:20] + record[21:]
```

Now, for an example with features, we'll use a GenBank file. Suppose you have a circular genome:

```

>>> from Bio import SeqIO
>>> record = SeqIO.read("NC_005816.gb", "genbank")
>>> record
SeqRecord(seq=Seq('TGTAACGAACGGTGCAATAGTGATCCACACCCAACGCCTGAAATCAGATCCAGG...CTG',
IUPACAmbiguousDNA()), id='NC_005816.1', name='NC_005816',
description='Yersinia pestis biovar Microtus str. 91001 plasmid pPCP1, complete sequence.',
dbxrefs=['Project:10638'])
>>> len(record)
9609
>>> len(record.features)
29
>>> record.dbxrefs
['Project:10638']
>>> record.annotations.keys()
['comment', 'sequence_version', 'source', 'taxonomy', 'keywords', 'references',
'accessions', 'data_file_division', 'date', 'organism', 'gi']

```

You can shift the origin like this:

```

>>> shifted = record[2000:] + record[:2000]
>>> shifted
SeqRecord(seq=Seq('GATACGCAGTCATATTTTTTACACAATTCTCTAATCCCGACAAGGTCGTAGGTC...GGA',
IUPACAmbiguousDNA()), id='NC_005816.1', name='NC_005816',
description='Yersinia pestis biovar Microtus str. 91001 plasmid pPCP1, complete sequence.',
dbxrefs=[])
>>> len(shifted)
9609

```

Note that this isn't perfect in that some annotation like the database cross references and one of the features (the source feature) have been lost:

```

>>> len(shifted.features)
28
>>> shifted.dbxrefs
[]
>>> record.annotations.keys()
[]

```

This is because the `SeqRecord` slicing step is cautious in what annotation it preserves (erroneously propagating annotation can cause major problems). If you want to keep the database cross references or the annotations dictionary, this must be done explicitly:

```

>>> shifted.dbxrefs = record.dbxrefs[:]
>>> shifted.annotations = record.annotations.copy()
>>> shifted.dbxrefs
['Project:10638']
>>> shifted.annotations.keys()
['comment', 'sequence_version', 'source', 'taxonomy', 'keywords', 'references',
'accessions', 'data_file_division', 'date', 'organism', 'gi']

```

Also note that in an example like this, you should probably change the record identifiers since the NCBI references refer to the *original* unmodified sequence.

Chapter 5

Sequence Input/Output

In this chapter we'll discuss in more detail the `Bio.SeqIO` module, which was briefly introduced in Chapter 2 and also used in Chapter 4. This aims to provide a simple interface for working with assorted sequence file formats in a uniform way. See also the `Bio.SeqIO` wiki page (<http://biopython.org/wiki/SeqIO>), and the built in documentation (also [online](#)):

```
>>> from Bio import SeqIO
>>> help(SeqIO)
...
```

The “catch” is that you have to work with `SeqRecord` objects (see Chapter 4), which contain a `Seq` object (see Chapter 3) plus annotation like an identifier and description.

5.1 Parsing or Reading Sequences

The workhorse function `Bio.SeqIO.parse()` is used to read in sequence data as `SeqRecord` objects. This function expects two arguments:

1. The first argument is a *handle* to read the data from, or a filename. A handle is typically a file opened for reading, but could be the output from a command line program, or data downloaded from the internet (see Section 5.2). See Section 18.1 for more about handles.
2. The second argument is a lower case string specifying sequence format – we don't try and guess the file format for you! See <http://biopython.org/wiki/SeqIO> for a full listing of supported formats.

As of Biopython 1.49 there is an optional argument `alphabet` to specify the alphabet to be used. This is useful for file formats like FASTA where otherwise `Bio.SeqIO` will default to a generic alphabet.

The `Bio.SeqIO.parse()` function returns an *iterator* which gives `SeqRecord` objects. Iterators are typically used in a for loop as shown below.

Sometimes you'll find yourself dealing with files which contain only a single record. For this situation Biopython 1.45 introduced the function `Bio.SeqIO.read()` which takes the same arguments. Provided there is one and only one record in the file, this is returned as a `SeqRecord` object. Otherwise an exception is raised.

5.1.1 Reading Sequence Files

In general `Bio.SeqIO.parse()` is used to read in sequence files as `SeqRecord` objects, and is typically used with a for loop like this:

```

from Bio import SeqIO
for seq_record in SeqIO.parse("ls_orchid.fasta", "fasta"):
    print seq_record.id
    print repr(seq_record.seq)
    print len(seq_record)

```

The above example is repeated from the introduction in Section 2.4, and will load the orchid DNA sequences in the FASTA format file `ls_orchid.fasta`. If instead you wanted to load a GenBank format file like `ls_orchid.gbk` then all you need to do is change the filename and the format string:

```

from Bio import SeqIO
for seq_record in SeqIO.parse("ls_orchid.gbk", "genbank"):
    print seq_record.id
    print seq_record.seq
    print len(seq_record)

```

Similarly, if you wanted to read in a file in another file format, then assuming `Bio.SeqIO.parse()` supports it you would just need to change the format string as appropriate, for example “swiss” for SwissProt files or “embl” for EMBL text files. There is a full listing on the wiki page (<http://biopython.org/wiki/SeqIO>) and in the built in documentation (also [online](#)).

Another very common way to use a Python iterator is within a list comprehension (or a generator expression). For example, if all you wanted to extract from the file was a list of the record identifiers we can easily do this with the following list comprehension:

```

>>> from Bio import SeqIO
>>> identifiers = [seq_record.id for seq_record in SeqIO.parse("ls_orchid.gbk", "genbank")]
>>> identifiers
['Z78533.1', 'Z78532.1', 'Z78531.1', 'Z78530.1', 'Z78529.1', 'Z78527.1', ..., 'Z78439.1']

```

There are more examples using `SeqIO.parse()` in a list comprehension like this in Section 14.2 (e.g. for plotting sequence lengths or GC%).

5.1.2 Iterating over the records in a sequence file

In the above examples, we have usually used a for loop to iterate over all the records one by one. You can use the for loop with all sorts of Python objects (including lists, tuples and strings) which support the iteration interface.

The object returned by `Bio.SeqIO` is actually an iterator which returns `SeqRecord` objects. You get to see each record in turn, but once and only once. The plus point is that an iterator can save you memory when dealing with large files.

Instead of using a for loop, can also use the `.next()` method of an iterator to step through the entries, like this:

```

from Bio import SeqIO
record_iterator = SeqIO.parse("ls_orchid.fasta", "fasta")

first_record = record_iterator.next()
print first_record.id
print first_record.description

second_record = record_iterator.next()
print second_record.id
print second_record.description

```

Note that if you try and use `.next()` and there are no more results, you'll either get back the special Python object `None` or a `StopIteration` exception.

One special case to consider is when your sequence files have multiple records, but you only want the first one. In this situation the following code is very concise:

```
from Bio import SeqIO
first_record = SeqIO.parse("ls_orchid.gbk", "genbank").next()
```

A word of warning here – using the `.next()` method like this will silently ignore any additional records in the file. If your files have *one and only one* record, like some of the online examples later in this chapter, or a GenBank file for a single chromosome, then use the new `Bio.SeqIO.read()` function instead. This will check there are no extra unexpected records present.

5.1.3 Getting a list of the records in a sequence file

In the previous section we talked about the fact that `Bio.SeqIO.parse()` gives you a `SeqRecord` iterator, and that you get the records one by one. Very often you need to be able to access the records in any order. The Python `list` data type is perfect for this, and we can turn the record iterator into a list of `SeqRecord` objects using the built-in Python function `list()` like so:

```
from Bio import SeqIO
records = list(SeqIO.parse("ls_orchid.gbk", "genbank"))

print "Found %i records" % len(records)

print "The last record"
last_record = records[-1] #using Python's list tricks
print last_record.id
print repr(last_record.seq)
print len(last_record)

print "The first record"
first_record = records[0] #remember, Python counts from zero
print first_record.id
print repr(first_record.seq)
print len(first_record)
```

Giving:

```
Found 94 records
The last record
Z78439.1
Seq('CATTGTTGAGATCACATAATAATTGATCGAGTTAATCTGGAGGATCTGTTTACT...GCC', IUPACAmbiguousDNA())
592
The first record
Z78533.1
Seq('CGTAACAAGGTTTCCGTAGGTGAACCTGCGGAAGGATCATTGATGAGACCGTGG...CGC', IUPACAmbiguousDNA())
740
```

You can of course still use a for loop with a list of `SeqRecord` objects. Using a list is much more flexible than an iterator (for example, you can determine the number of records from the length of the list), but does need more memory because it will hold all the records in memory at once.

5.1.4 Extracting data

The `SeqRecord` object and its annotation structures are described more fully in Chapter 4. As an example of how annotations are stored, we'll look at the output from parsing the first record in the GenBank file [ls_orchid.gbk](#).

```
from Bio import SeqIO
record_iterator = SeqIO.parse("ls_orchid.gbk", "genbank")
first_record = record_iterator.next()
print first_record
```

That should give something like this:

```
ID: Z78533.1
Name: Z78533
Description: C.irapeanum 5.8S rRNA gene and ITS1 and ITS2 DNA.
Number of features: 5
/sequence_version=1
/source=Cypripedium irapeanum
/taxonomy=['Eukaryota', 'Viridiplantae', 'Streptophyta', ..., 'Cypripedium']
/keywords=['5.8S ribosomal RNA', '5.8S rRNA gene', ..., 'ITS1', 'ITS2']
/references=[...]
/accessions=['Z78533']
/data_file_division=PLN
/date=30-NOV-2006
/organism=Cypripedium irapeanum
/gi=2765658
Seq('CGTAACAAGGTTTCCCGTAGGTGAACCTGCGGAAGGATCATTGATGAGACCGTGG...CGC', IUPACAmbiguousDNA())
```

This gives a human readable summary of most of the annotation data for the `SeqRecord`. For this example we're going to use the `.annotations` attribute which is just a Python dictionary. The contents of this annotations dictionary were shown when we printed the record above. You can also print them out directly:

```
print first_record.annotations
```

Like any Python dictionary, you can easily get a list of the keys:

```
print first_record.annotations.keys()
```

or values:

```
print first_record.annotations.values()
```

In general, the annotation values are strings, or lists of strings. One special case is any references in the file get stored as reference objects.

Suppose you wanted to extract a list of the species from the [ls_orchid.gbk](#) GenBank file. The information we want, *Cypripedium irapeanum*, is held in the annotations dictionary under 'source' and 'organism', which we can access like this:

```
>>> print first_record.annotations["source"]
Cypripedium irapeanum
```

or:

```
>>> print first_record.annotations["organism"]
Cypripedium irapeanum
```

In general, 'organism' is used for the scientific name (in Latin, e.g. *Arabidopsis thaliana*), while 'source' will often be the common name (e.g. thale cress). In this example, as is often the case, the two fields are identical.

Now let's go through all the records, building up a list of the species each orchid sequence is from:

```
from Bio import SeqIO
all_species = []
for seq_record in SeqIO.parse("ls_orchid.gbk", "genbank"):
    all_species.append(seq_record.annotations["organism"])
print all_species
```

Another way of writing this code is to use a list comprehension:

```
from Bio import SeqIO
all_species = [seq_record.annotations["organism"] for seq_record in \
                SeqIO.parse("ls_orchid.gbk", "genbank")]
print all_species
```

In either case, the result is:

```
['Cypripedium irapeanum', 'Cypripedium californicum', ..., 'Paphiopedilum barbatum']
```

Great. That was pretty easy because GenBank files are annotated in a standardised way.

Now, let's suppose you wanted to extract a list of the species from a FASTA file, rather than the GenBank file. The bad news is you will have to write some code to extract the data you want from the record's description line - if the information is in the file in the first place! Our example FASTA format file [ls_orchid.fasta](#) starts like this:

```
>gi|2765658|emb|Z78533.1|CIZ78533 C.irapeanum 5.8S rRNA gene and ITS1 and ITS2 DNA
CGTAACAAGGTTTCCGTAGGTGAACCTGCGGAAGGATCATTGATGAGACCGTGAATAAACGATCGAGTG
AATCCGGAGGACCGGTGTACTCAGCTACCGGGGGCATTGCTCCCGTGGTGACCCTGATTGTTGTTGGG
...
```

You can check by hand, but for every record the species name is in the description line as the second word. This means if we break up each record's `.description` at the spaces, then the species is there as field number one (field zero is the record identifier). That means we can do this:

```
from Bio import SeqIO
all_species = []
for seq_record in SeqIO.parse("ls_orchid.fasta", "fasta"):
    all_species.append(seq_record.description.split()[1])
print all_species
```

This gives:

```
['C.irapeanum', 'C.californicum', 'C.fasciculatum', 'C.margaritaceum', ..., 'P.barbatum']
```

The concise alternative using list comprehensions would be:

```
from Bio import SeqIO
all_species == [seq_record.description.split()[1] for seq_record in \
                SeqIO.parse("ls_orchid.fasta", "fasta")]
print all_species
```

In general, extracting information from the FASTA description line is not very nice. If you can get your sequences in a well annotated file format like GenBank or EMBL, then this sort of annotation information is much easier to deal with.

5.2 Parsing sequences from the net

In the previous section, we looked at parsing sequence data from a file. Instead of using a filename, you can give `Bio.SeqIO` a handle (see Section 18.1), and in this section we'll use handles to internet connections to download sequences.

Note that just because you *can* download sequence data and parse it into a `SeqRecord` object in one go doesn't mean this is a good idea. In general, you should probably download sequences *once* and save them to a file for reuse.

5.2.1 Parsing GenBank records from the net

Section 8.6 talks about the Entrez EFetch interface in more detail, but for now let's just connect to the NCBI and get a few *Opuntia* (prickly-pear) sequences from GenBank using their GI numbers.

First of all, let's fetch just one record. If you don't care about the annotations and features downloading a FASTA file is a good choice as these are compact. Now remember, when you expect the handle to contain one and only one record, use the `Bio.SeqIO.read()` function:

```
from Bio import Entrez
from Bio import SeqIO
handle = Entrez.efetch(db="nucleotide", rettype="fasta", id="6273291")
seq_record = SeqIO.read(handle, "fasta")
handle.close()
print "%s with %i features" % (seq_record.id, len(seq_record.features))
```

Expected output:

```
gi|6273291|gb|AF191665.1|AF191665 with 0 features
```

The NCBI will also let you ask for the file in other formats, in particular as a GenBank file. Until Easter 2009, the Entrez EFetch API let you use "genbank" as the return type, however the NCBI now insist on using the official return types of "gb" (or "gp" for proteins) as described on [EFetch for Sequence and other Molecular Biology Databases](#). As a result, in Biopython 1.50 onwards, we support "gb" as an alias for "genbank" in `Bio.SeqIO`.

```
from Bio import Entrez
from Bio import SeqIO
handle = Entrez.efetch(db="nucleotide", rettype="gb", id="6273291")
seq_record = SeqIO.read(handle, "gb") #using "gb" as an alias for "genbank"
handle.close()
print "%s with %i features" % (seq_record.id, len(seq_record.features))
```

The expected output of this example is:

```
AF191665.1 with 3 features
```

Notice this time we have three features.

Now let's fetch several records. This time the handle contains multiple records, so we must use the `Bio.SeqIO.parse()` function:

```
from Bio import Entrez
from Bio import SeqIO
handle = Entrez.efetch(db="nucleotide", rettype="gb", \
                      id="6273291,6273290,6273289")
for seq_record in SeqIO.parse(handle, "gb"):
```

```

    print seq_record.id, seq_record.description[:50] + "..."
    print "Sequence length %i," % len(seq_record),
    print "%i features," % len(seq_record.features),
    print "from: %s" % seq_record.annotations["source"]
handle.close()

```

That should give the following output:

```

AF191665.1 Opuntia marenae rpl16 gene; chloroplast gene for c...
Sequence length 902, 3 features, from: chloroplast Opuntia marenae
AF191664.1 Opuntia clavata rpl16 gene; chloroplast gene for c...
Sequence length 899, 3 features, from: chloroplast Grusonia clavata
AF191663.1 Opuntia bradtiana rpl16 gene; chloroplast gene for...
Sequence length 899, 3 features, from: chloroplast Opuntia bradtiana

```

See Chapter 8 for more about the `Bio.Entrez` module, and make sure to read about the NCBI guidelines for using Entrez (Section 8.1).

5.2.2 Parsing SwissProt sequences from the net

Now let's use a handle to download a SwissProt file from ExPASy, something covered in more depth in Chapter 9. As mentioned above, when you expect the handle to contain one and only one record, use the `Bio.SeqIO.read()` function:

```

from Bio import ExPASy
from Bio import SeqIO
handle = ExPASy.get_sprot_raw("023729")
seq_record = SeqIO.read(handle, "swiss")
handle.close()
print seq_record.id
print seq_record.name
print seq_record.description
print repr(seq_record.seq)
print "Length %i" % len(seq_record)
print seq_record.annotations["keywords"]

```

Assuming your network connection is OK, you should get back:

```

023729
CHS3_BROFI
RecName: Full=Chalcone synthase 3; EC=2.3.1.74; AltName: Full=Naringenin-chalcone synthase 3;
Seq('MAPAMEEIRQAQRAEGPAAVLAIGTSTPPNALYQADYPDYYFRITKSEHLTELK...GAE', ProteinAlphabet())
Length 394
['Acyltransferase', 'Flavonoid biosynthesis', 'Transferase']

```

5.3 Sequence files as Dictionaries – In memory

The next thing that we'll do with our ubiquitous orchid files is to show how to index them and access them like a database using the Python dictionary data type (like a hash in Perl). This is very useful for moderately large files where you only need to access certain elements of the file, and makes for a nice quick 'n dirty database. For dealing with larger files where memory becomes a problem, see Section 5.4 below.

You can use the function `Bio.SeqIO.to_dict()` to make a `SeqRecord` dictionary (in memory). By default this will use each record's identifier (i.e. the `.id` attribute) as the key. Let's try this using our GenBank file:

```
from Bio import SeqIO
orchid_dict = SeqIO.to_dict(SeqIO.parse("ls_orchid.gbk", "genbank"))
```

There is just one required argument for `Bio.SeqIO.to_dict()`, a list or generator giving `SeqRecord` objects. Here we have just used the output from the `SeqIO.parse` function. As the name suggests, this returns a Python dictionary.

Since this variable `orchid_dict` is an ordinary Python dictionary, we can look at all of the keys we have available:

```
>>> len(orchid_dict)
94
>>> print orchid_dict.keys()
['Z78484.1', 'Z78464.1', 'Z78455.1', 'Z78442.1', 'Z78532.1', 'Z78453.1', ..., 'Z78471.1']
```

If you really want to, you can even look at all the records at once:

```
>>> orchid_dict.values() #lots of output!
...
```

We can access a single `SeqRecord` object via the keys and manipulate the object as normal:

```
>>> seq_record = orchid_dict["Z78475.1"]
>>> print seq_record.description
P.supardii 5.8S rRNA gene and ITS1 and ITS2 DNA
>>> print repr(seq_record.seq)
Seq('CGTAACAAGGTTTCCGTAGGTGAACCTGCGGAAGGATCATTGTTGAGATCACAT...GGT', IUPACAmbiguousDNA())
```

So, it is very easy to create an in memory “database” of our GenBank records. Next we’ll try this for the FASTA file instead.

Note that those of you with prior Python experience should all be able to construct a dictionary like this “by hand”. However, typical dictionary construction methods will not deal with the case of repeated keys very nicely. Using the `Bio.SeqIO.to_dict()` will explicitly check for duplicate keys, and raise an exception if any are found.

5.3.1 Specifying the dictionary keys

Using the same code as above, but for the FASTA file instead:

```
from Bio import SeqIO
orchid_dict = SeqIO.to_dict(SeqIO.parse("ls_orchid.fasta", "fasta"))
print orchid_dict.keys()
```

This time the keys are:

```
['gi|2765596|emb|Z78471.1|PDZ78471', 'gi|2765646|emb|Z78521.1|CCZ78521', ...
..., 'gi|2765613|emb|Z78488.1|PTZ78488', 'gi|2765583|emb|Z78458.1|PHZ78458']
```

You should recognise these strings from when we parsed the FASTA file earlier in Section 2.4.1. Suppose you would rather have something else as the keys - like the accession numbers. This brings us nicely to `SeqIO.to_dict()`’s optional argument `key_function`, which lets you define what to use as the dictionary key for your records.

First you must write your own function to return the key you want (as a string) when given a `SeqRecord` object. In general, the details of function will depend on the sort of input records you are dealing with. But for our orchids, we can just split up the record’s identifier using the “pipe” character (the vertical line) and return the fourth entry (field three):

```
def get_accession(record):
    """Given a SeqRecord, return the accession number as a string.

    e.g. "gi|2765613|emb|Z78488.1|PTZ78488" -> "Z78488.1"
    """
    parts = record.id.split("|")
    assert len(parts) == 5 and parts[0] == "gi" and parts[2] == "emb"
    return parts[3]
```

Then we can give this function to the `SeqIO.to_dict()` function to use in building the dictionary:

```
from Bio import SeqIO
orchid_dict = SeqIO.to_dict(SeqIO.parse("ls_orchid.fasta", "fasta"), key_function=get_accession)
print orchid_dict.keys()
```

Finally, as desired, the new dictionary keys:

```
>>> print orchid_dict.keys()
['Z78484.1', 'Z78464.1', 'Z78455.1', 'Z78442.1', 'Z78532.1', 'Z78453.1', ..., 'Z78471.1']
```

Not too complicated, I hope!

5.3.2 Indexing a dictionary using the SEGUID checksum

To give another example of working with dictionaries of `SeqRecord` objects, we'll use the SEGUID checksum function. This is a relatively recent checksum, and collisions should be very rare (i.e. two different sequences with the same checksum), an improvement on the CRC64 checksum.

Once again, working with the orchids GenBank file:

```
from Bio import SeqIO
from Bio.SeqUtils.CheckSum import seguid
for record in SeqIO.parse("ls_orchid.gb", "genbank"):
    print record.id, seguid(record.seq)
```

This should give:

```
Z78533.1 JUEoWn6DPhgZ9nAyowsgtoD9TTo
Z78532.1 MN/s0q9zDoCVEEc+k/IFwCNF2pY
...
Z78439.1 H+JfaShya/4yyAj7IbMqgNkxdxQ
```

Now, recall the `Bio.SeqIO.to_dict()` function's `key_function` argument expects a function which turns a `SeqRecord` into a string. We can't use the `seguid()` function directly because it expects to be given a `Seq` object (or a string). However, we can use Python's `lambda` feature to create a "one off" function to give to `Bio.SeqIO.to_dict()` instead:

```
from Bio import SeqIO
from Bio.SeqUtils.CheckSum import seguid
seguid_dict = SeqIO.to_dict(SeqIO.parse("ls_orchid.gb", "genbank"),
                           lambda rec : seguid(rec.seq))
record = seguid_dict["MN/s0q9zDoCVEEc+k/IFwCNF2pY"]
print record.id
print record.description
```

That should have retrieved the record Z78532.1, the second entry in the file.

5.4 Sequence files as Dictionaries – Indexed files

As the previous couple of examples tried to illustrate, using `Bio.SeqIO.to_dict()` is very flexible. However, because it holds everything in memory, the size of file you can work with is limited by your computer's RAM. In general, this will only work on small to medium files.

For very large files, Biopython 1.52 introduced an alternative, `Bio.SeqIO.index()`, which works a little differently. Although it still returns a dictionary like object, this does *not* keep *everything* in memory. Instead, it just records where each record is within the file – when you ask for a particular record, it then parses it on demand.

As an example, let's use the same GenBank file as before:

```
>>> from Bio import SeqIO
>>> orchid_dict = SeqIO.index("ls_orchid.gbk", "genbank")
>>> len(orchid_dict)
94
>>> orchid_dict.keys()
['Z78484.1', 'Z78464.1', 'Z78455.1', 'Z78442.1', 'Z78532.1', 'Z78453.1', ..., 'Z78471.1']
>>> seq_record = orchid_dict["Z78475.1"]
>>> print seq_record.description
P.supardii 5.8S rRNA gene and ITS1 and ITS2 DNA
>>> seq_record.seq
Seq('CGTAACAAGGTTTCCTAGGTGAACCTGCGGAAGGATCATTGTTGAGATCACAT...GGT', IUPACAmbiguousDNA())
```

Note that `Bio.SeqIO.index()` won't take a handle, but only a filename. There are good reasons for this, but it is a little technical. The second argument is the file format (a lower case string as used in the other `Bio.SeqIO` functions). You can use many other simple file formats, including FASTA and FASTQ files (see the example in Section 14.1.9). However, alignment formats like PHYLIP or Clustal are not supported. Finally as an optional argument you can supply an alphabet, or a key function.

Here is the same example using the FASTA file - all we change is the filename and the format name:

```
>>> from Bio import SeqIO
>>> orchid_dict = SeqIO.index("ls_orchid.fasta", "fasta")
>>> len(orchid_dict)
94
>>> orchid_dict.keys()
['gi|2765596|emb|Z78471.1|PDZ78471', 'gi|2765646|emb|Z78521.1|CCZ78521', ...
..., 'gi|2765613|emb|Z78488.1|PTZ78488', 'gi|2765583|emb|Z78458.1|PHZ78458']
```

5.4.1 Specifying the dictionary keys

Suppose you want to use the same keys as before? Much like with the `Bio.SeqIO.to_dict()` example in Section 5.3.1, you'll need to write a tiny function to map from the FASTA identifier (as a string) to the key you want:

```
def get_acc(identifier):
    """Given a SeqRecord identifier string, return the accession number as a string.

    e.g. "gi|2765613|emb|Z78488.1|PTZ78488" -> "Z78488.1"
    """
    parts = identifier.split("|")
    assert len(parts) == 5 and parts[0] == "gi" and parts[2] == "emb"
    return parts[3]
```

Then we can give this function to the `Bio.SeqIO.index()` function to use in building the dictionary:

```
>>> from Bio import SeqIO
>>> orchid_dict = SeqIO.index("ls_orchid.fasta", "fasta", key_function=get_acc)
>>> print orchid_dict.keys()
['Z78484.1', 'Z78464.1', 'Z78455.1', 'Z78442.1', 'Z78532.1', 'Z78453.1', ..., 'Z78471.1']
```

Easy when you know how?

5.4.2 Getting the raw data for a record

The dictionary-like object from `Bio.SeqIO.index()` gives you each entry as a `SeqRecord` object. However, it is sometimes useful to be able to get the original raw data straight from the file. For this reason Biopython 1.54 added a `get_raw()` method which takes a single argument (the record identifier) and returns a string (extracted from the file without modification).

A motivating example is extracting a subset of a records from a large file where either `Bio.SeqIO.write()` does not (yet) support the output file format (e.g. the plain text SwissProt file format) or where you need to preserve the text exactly (e.g. GenBank or EMBL output from Biopython does not yet preserve every last bit of annotation).

Let's suppose you have download the whole of UniProt in the plain text SwissPort file format from their FTP site (ftp://ftp.uniprot.org/pub/databases/uniprot/current_release/knowledgebase/complete/uniprot_sprot.dat.gz) and uncompressed it as the file `uniprot_sprot.dat`, and you want to extract just a few records from it:

```
>>> from Bio import SeqIO
>>> uniprot = SeqIO.index("uniprot_sprot.dat", "swiss")
>>> handle = open("selected.dat", "w")
>>> for acc in ["P33487", "P19801", "P13689", "Q8JZQ5", "Q9TRC7"]:
...     handle.write(uniprot.get_raw(acc))
>>> handle.close()
```

There is a longer example in Section 14.1.3 using the `SeqIO.index()` function to sort a large sequence file (without loading everything into memory at once).

5.4.3 Discussion

While using `Bio.SeqIO.index()` is much more memory-efficient than using a simple dictionary of records, the record keys and the offsets are still in memory. This works fine even for millions of sequences. However, if you have tens of millions of sequences, then you *will* need *lots* of RAM (and a 64bit version of Python in order to use more than 4GB of RAM). Future versions of Biopython may support storing the index on disk (e.g. in an SQLite database) rather than in memory in order to work better with such extreme cases.

Although the main benefit of using `Bio.SeqIO.index()` is to reduce memory requirements, you will also find building the index is much faster than using `Bio.SeqIO.to_dict()` and `Bio.SeqIO.parse()` (as the indexing only scans the file quickly looking for the start of each record).

The main drawback is less flexibility. You cannot specify the keys with quite the same freedom as you can with `Bio.SeqIO.to_dict()`. Also, these indexed dictionaries are *read only*, so you cannot add or remove entries as you could with a real Python dictionary.

5.5 Writing Sequence Files

We've talked about using `Bio.SeqIO.parse()` for sequence input (reading files), and now we'll look at `Bio.SeqIO.write()` which is for sequence output (writing files). This is a function taking three arguments: some `SeqRecord` objects, a handle or filename to write to, and a sequence format.

Here is an example, where we start by creating a few SeqRecord objects the hard way (by hand, rather than by loading them from a file):

```
from Bio.Seq import Seq
from Bio.SeqRecord import SeqRecord
from Bio.Alphabet import generic_protein

rec1 = SeqRecord(Seq("MMYQQGCFAGGTVLRRLAKDLAENNRGARVLVVCSEITAVTFRGPSETHLDSMVGQALFGD" \
    + "GAGAVIVGSDPDLSEVERPLYELVWTGATLLPDSEGAIDGHLREVGLTFHLLKDVPLGLISK" \
    + "NIEKSLKEAFTPLGISDWNSTFWIAHPGGPAILDQVEAKLGLKKEEMRATREVLSEYGNM" \
    + "SSAC", generic_protein),
    id="gi|14150838|gb|AAK54648.1|AF376133_1",
    description="chalcone synthase [Cucumis sativus]")

rec2 = SeqRecord(Seq("YPDYYFRITNREHKAELKEKFQRMCDKSMIKKRYMYLTEEILKENPSMCEYMAPSLDARQ" \
    + "DMVVVEIPKLGKEAAVKAIKEWGQ", generic_protein),
    id="gi|13919613|gb|AAK33142.1|",
    description="chalcone synthase [Fragaria vesca subsp. bracteata]")

rec3 = SeqRecord(Seq("MVTVEEFRAQCAEGPATVMAIGTATPSNCVDQSTYPDYYFRITNSEHKVELKEKFKRMC" \
    + "EKSMIKKRYMHLTEEILKENPNICAYMAPSLDARQDIVVVEVPKLGKEAAQKAIKEWGQP" \
    + "KSKITHLVFCTTSGVDMPGCDYQLTKLLGLRPSVKRFMMYQQGCFAGGTVLRMAKDLAEN" \
    + "NKGARVLVVCSEITAVTFRGPNDTHLDSLQALFGDGAAAVIIGSDPIPEVERPLFELV" \
    + "SAAQTLPLDSEGAIDGHLREVGLTFHLLKDVPLGLISKNIEKSLVEAFQPLGISDWNLSFW" \
    + "IAHPGGPAILDQVELKLGKQEKLKATRVLVSNYGNMSSACVLFILDEMRSASAKEGLGT" \
    + "TGELEWGVLFVGFPGPLTVETVVLHVSAT", generic_protein),
    id="gi|13925890|gb|AAK49457.1|",
    description="chalcone synthase [Nicotiana tabacum]")

my_records = [rec1, rec2, rec3]
```

Now we have a list of SeqRecord objects, we'll write them to a FASTA format file:

```
from Bio import SeqIO
SeqIO.write(my_records, "my_example.faa", "fasta")
```

And if you open this file in your favourite text editor it should look like this:

```
>gi|14150838|gb|AAK54648.1|AF376133_1 chalcone synthase [Cucumis sativus]
MMYQQGCFAGGTVLRRLAKDLAENNRGARVLVVCSEITAVTFRGPSETHLDSMVGQALFGD
GAGAVIVGSDPDLSEVERPLYELVWTGATLLPDSEGAIDGHLREVGLTFHLLKDVPLGLISK
NIEKSLKEAFTPLGISDWNSTFWIAHPGGPAILDQVEAKLGLKKEEMRATREVLSEYGNM
SSAC
>gi|13919613|gb|AAK33142.1| chalcone synthase [Fragaria vesca subsp. bracteata]
YPDYYFRITNREHKAELKEKFQRMCDKSMIKKRYMYLTEEILKENPSMCEYMAPSLDARQ
DMVVVEIPKLGKEAAVKAIKEWGQ
>gi|13925890|gb|AAK49457.1| chalcone synthase [Nicotiana tabacum]
MVTVEEFRAQCAEGPATVMAIGTATPSNCVDQSTYPDYYFRITNSEHKVELKEKFKRMC
EKSMIKKRYMHLTEEILKENPNICAYMAPSLDARQDIVVVEVPKLGKEAAQKAIKEWGQP
KSKITHLVFCTTSGVDMPGCDYQLTKLLGLRPSVKRFMMYQQGCFAGGTVLRMAKDLAEN
NKGARVLVVCSEITAVTFRGPNDTHLDSLQALFGDGAAAVIIGSDPIPEVERPLFELV
SAAQTLPLDSEGAIDGHLREVGLTFHLLKDVPLGLISKNIEKSLVEAFQPLGISDWNLSFW
IAHPGGPAILDQVELKLGKQEKLKATRVLVSNYGNMSSACVLFILDEMRSASAKEGLGT
TGELEWGVLFVGFPGPLTVETVVLHVSAT
```

Suppose you wanted to know how many records the `Bio.SeqIO.write()` function wrote to the handle? If your records were in a list you could just use `len(my_records)`, however you can't do that when your records come from a generator/iterator. Therefore as of Biopython 1.49, the `Bio.SeqIO.write()` function returns the number of `SeqRecord` objects written to the file.

Note - If you tell the `Bio.SeqIO.write()` function to write to a file that already exists, the old file will be overwritten without any warning.

5.5.1 Round trips

Some people like their parsers to be “round-tripable”, meaning if you read in a file and write it back out again it is unchanged. This requires that the parser must extract enough information to reproduce the original file *exactly*. `Bio.SeqIO` does *not* aim to do this.

As a trivial example, any line wrapping of the sequence data in FASTA files is allowed. An identical `SeqRecord` would be given from parsing the following two examples which differ only in their line breaks:

```
>YAL068C-7235.2170 Putative promoter sequence
TACGAGAATAATTTCTCATCATCCAGCTTTAACACAAAATTCGCACAGTTTTCGTTAAGA
GAACCTAACATTTTCTTATGACGTAATGAAGTTTATATATAAATTCCTTTTTATTGGA
```

```
>YAL068C-7235.2170 Putative promoter sequence
TACGAGAATAATTTCTCATCATCCAGCTTTAACACAAAATTCGCA
CAGTTTTCGTTAAGAGAACTTAACATTTTCTTATGACGTAATGA
AGTTTATATATAAATTCCTTTTTATTGGA
```

To make a round-tripable FASTA parser you would need to keep track of where the sequence line breaks occurred, and this extra information is usually pointless. Instead Biopython uses a default line wrapping of 60 characters on output. The same problem with white space applies in many other file formats too. Another issue in some cases is that Biopython does not (yet) preserve every last bit of annotation (e.g. GenBank and EMBL).

Occasionally preserving the original layout (with any quirks it may have) is important. See Section 5.4.2 about the `get_raw()` method of the `Bio.SeqIO.index()` dictionary-like object for one potential solution.

5.5.2 Converting between sequence file formats

In previous example we used a list of `SeqRecord` objects as input to the `Bio.SeqIO.write()` function, but it will also accept a `SeqRecord` iterator like we get from `Bio.SeqIO.parse()` – this lets us do file conversion by combining these two functions.

For this example we'll read in the GenBank format file `ls_orchid.gbk` and write it out in FASTA format:

```
from Bio import SeqIO
records = SeqIO.parse("ls_orchid.gbk", "genbank")
count = SeqIO.write(records, "my_example.fasta", "fasta")
print "Converted %i records" % count
```

Still, that is a little bit complicated. So, because file conversion is such a common task, Biopython 1.52 introduced a helper function letting you replace that with just:

```
from Bio import SeqIO
count = SeqIO.convert("ls_orchid.gbk", "genbank", "my_example.fasta", "fasta")
print "Converted %i records" % count
```

The `Bio.SeqIO.convert()` function will take handles *or* filenames. Watch out though – if the output file already exists, it will overwrite it! To find out more, see the built in help:

```
>>> from Bio import SeqIO
>>> help(SeqIO.convert)
...
```

In principle, just by changing the filenames and the format names, this code could be used to convert between any file formats available in Biopython. However, writing some formats requires information (e.g. quality scores) which other file formats don't contain. For example, while you can turn a FASTQ file into a FASTA file, you can't do the reverse. See also Sections 14.1.7 and 14.1.8 in the cookbook chapter which looks at inter-converting between different FASTQ formats.

Finally, as an added incentive for using the `Bio.SeqIO.convert()` function (on top of the fact your code will be shorter), doing it this way may also be faster! The reason for this is the `convert` function can take advantage of several file format specific optimisations and tricks.

5.5.3 Converting a file of sequences to their reverse complements

Suppose you had a file of nucleotide sequences, and you wanted to turn it into a file containing their reverse complement sequences. This time a little bit of work is required to transform the `SeqRecord` objects we get from our input file into something suitable for saving to our output file.

To start with, we'll use `Bio.SeqIO.parse()` to load some nucleotide sequences from a file, then print out their reverse complements using the `Seq` object's built in `.reverse_complement()` method (see Section 3.7):

```
from Bio import SeqIO
for record in SeqIO.parse("ls_orchid.gb", "genbank"):
    print record.id
    print record.seq.reverse_complement()
```

Now, if we want to save these reverse complements to a file, we'll need to make `SeqRecord` objects. For this I think its most elegant to write our own function, where we can decide how to name our new records:

```
from Bio.SeqRecord import SeqRecord

def make_rc_record(record):
    """Returns a new SeqRecord with the reverse complement sequence."""
    return SeqRecord(seq = record.seq.reverse_complement(), \
                    id = "rc_" + record.id, \
                    description = "reverse complement")
```

We can then use this to turn the input records into reverse complement records ready for output. If you don't mind about having all the records in memory at once, then the Python `map()` function is a very intuitive way of doing this:

```
from Bio import SeqIO
records = map(make_rc_record, SeqIO.parse("ls_orchid.fasta", "fasta"))
SeqIO.write(records, "rev_comp.fasta", "fasta")
```

This is an excellent place to demonstrate the power of list comprehensions which in their simplest are a long-winded equivalent to using `map()`, like this:

```
records = [make_rc_record(rec) for rec in SeqIO.parse("ls_orchid.fasta", "fasta")]
```

Now list comprehensions have a nice trick up their sleeves, you can add a conditional statement:

```
records = [make_rc_record(rec) for rec in SeqIO.parse("ls_orchid.fasta", "fasta") if len(rec)<700]
```

That would create an in memory list of reverse complement records where the sequence length was under 700 base pairs. However, we can do exactly the same with a generator expression - but with the advantage that this does not create a list of all the records in memory at once:

```
records = (make_rc_record(rec) for rec in SeqIO.parse("ls_orchid.fasta", "fasta") if len(rec)<700)
```

As a complete example:

```
from Bio import SeqIO
records = (make_rc_record(rec) for rec in SeqIO.parse("ls_orchid.fasta", "fasta") if len(rec)<700)
SeqIO.write(records, "rev_comp.fasta", "fasta")
```

There is a related example in Section 14.1.2, translating each record in a FASTA file from nucleotides to amino acids.

5.5.4 Getting your SeqRecord objects as formatted strings

Suppose that you don't really want to write your records to a file or handle - instead you want a string containing the records in a particular file format. The `Bio.SeqIO` interface is based on handles, but Python has a useful built in module which provides a string based handle.

For an example of how you might use this, let's load in a bunch of `SeqRecord` objects from our orchids GenBank file, and create a string containing the records in FASTA format:

```
from Bio import SeqIO
from StringIO import StringIO
records = SeqIO.parse("ls_orchid.gb", "genbank")
out_handle = StringIO()
SeqIO.write(records, out_handle, "fasta")
fasta_data = out_handle.getvalue()
print fasta_data
```

This isn't entirely straightforward the first time you see it! On the bright side, for the special case where you would like a string containing a *single* record in a particular file format, Biopython 1.48 added a new `format()` method to the `SeqRecord` class (see Section 4.5).

Note that although we don't encourage it, you *can* use the `format()` method to write to a file, for example something like this:

```
from Bio import SeqIO
out_handle = open("ls_orchid_long.tab", "w")
for record in SeqIO.parse("ls_orchid.gb", "genbank"):
    if len(record) > 100:
        out_handle.write(record.format("tab"))
out_handle.close()
```

While this style of code will work for a simple sequential file format like FASTA or the simple tab separated format used here, it will *not* work for more complex or interlaced file formats. This is why we still recommend using `Bio.SeqIO.write()`, as in the following example:

```
from Bio import SeqIO
records = (rec for rec in SeqIO.parse("ls_orchid.gb", "genbank") if len(rec) > 100)
SeqIO.write(records, "ls_orchid.tab", "tab")
```

Making a single call to `SeqIO.write(...)` is also much quicker than multiple calls to the `SeqRecord.format(...)` method.

Chapter 6

Multiple Sequence Alignment objects

This chapter is about Multiple Sequence Alignments, by which we mean a collection of multiple sequences which have been aligned together – usually with the insertion of gap characters, and addition of leading or trailing gaps – such that all the sequence strings are the same length. Such an alignment can be regarded as a matrix of letters, where each row is held as a `SeqRecord` object internally.

We will introduce the `MultipleSeqAlignment` object which holds this kind of data, and the `Bio.AlignIO` module for reading and writing them as various file formats (following the design of the `Bio.SeqIO` module from the previous chapter). Note that both `Bio.SeqIO` and `Bio.AlignIO` can read and write sequence alignment files. The appropriate choice will depend largely on what you want to do with the data.

The final part of this chapter is about our command line wrappers for common multiple sequence alignment tools like ClustalW and MUSCLE.

6.1 Parsing or Reading Sequence Alignments

We have two functions for reading in sequence alignments, `Bio.AlignIO.read()` and `Bio.AlignIO.parse()` which following the convention introduced in `Bio.SeqIO` are for files containing one or multiple alignments respectively.

Using `Bio.AlignIO.parse()` will return an *iterator* which gives `MultipleSeqAlignment` objects. Iterators are typically used in a for loop. Examples of situations where you will have multiple different alignments include resampled alignments from the PHYLIP tool `seqboot`, or multiple pairwise alignments from the EMBOSS tools `water` or `needle`, or Bill Pearson's FASTA tools.

However, in many situations you will be dealing with files which contain only a single alignment. In this case, you should use the `Bio.AlignIO.read()` function which returns a single `MultipleSeqAlignment` object.

Both functions expect two mandatory arguments:

1. The first argument is a *handle* to read the data from, typically an open file (see Section 18.1), or a filename.
2. The second argument is a lower case string specifying the alignment format. As in `Bio.SeqIO` we don't try and guess the file format for you! See <http://biopython.org/wiki/AlignIO> for a full listing of supported formats.

There is also an optional `seq_count` argument which is discussed in Section 6.1.3 below for dealing with ambiguous file formats which may contain more than one alignment.

Biopython 1.49 introduced a further optional `alphabet` argument allowing you to specify the expected alphabet. This can be useful as many alignment file formats do not explicitly label the sequences as RNA, DNA or protein – which means `Bio.AlignIO` will default to using a generic alphabet.

6.1.1 Single Alignments

As an example, consider the following annotation rich protein alignment in the PFAM or Stockholm file format:

```
# STOCKHOLM 1.0
#=GS COATB_BPIKE/30-81 AC P03620.1
#=GS COATB_BPIKE/30-81 DR PDB; 1if1 ; 1-52;
#=GS Q9TOQ8_BPIKE/1-52 AC Q9TOQ8.1
#=GS COATB_BPI22/32-83 AC P15416.1
#=GS COATB_BPM13/24-72 AC P69541.1
#=GS COATB_BPM13/24-72 DR PDB; 2cpb ; 1-49;
#=GS COATB_BPM13/24-72 DR PDB; 2cps ; 1-49;
#=GS COATB_BPZJ2/1-49 AC P03618.1
#=GS Q9TOQ9_BPF1/1-49 AC Q9TOQ9.1
#=GS Q9TOQ9_BPF1/1-49 DR PDB; 1nh4 A; 1-49;
#=GS COATB_BPIF1/22-73 AC P03619.2
#=GS COATB_BPIF1/22-73 DR PDB; 1ifk ; 1-50;
COATB_BPIKE/30-81 AEPNAATNYATEAMDSLKTQAIDLISQTWPVVTTVVVAGLVIRLFKKFSSKA
#=GR COATB_BPIKE/30-81 SS -HHHHHHHHHHHHHH--HHHHHHHH--HHHHHHHHHHHHHHHHHHHHHH----
Q9TOQ8_BPIKE/1-52 AEPNAATNYATEAMDSLKTQAIDLISQTWPVVTTVVVAGLVIKLFKKFVSRA
COATB_BPI22/32-83 DGTSTATSYATEAMNSLKTQATDLIDQTWPVVTSVAVAGLAIRLFKKFSSKA
COATB_BPM13/24-72 AEGDDP...AKAAFNSLQASATEYIGYAWAMVVVIVGATIGIKLFKKFSSKA
#=GR COATB_BPM13/24-72 SS ---S-T...CHCHHHHCCCCTCCCTTCHHHHHHHHHHHHHHHHHHHHHCTT--
COATB_BPZJ2/1-49 AEGDDP...AKAAFDSLQASATEYIGYAWAMVVVIVGATIGIKLFKKFASKA
Q9TOQ9_BPF1/1-49 AEGDDP...AKAAFDSLQASATEYIGYAWAMVVVIVGATIGIKLFKKFSSKA
#=GR Q9TOQ9_BPF1/1-49 SS -----...HHHHHHHHHHHHHHHHHHHHHHHHHHHHHHHHHHHHHH--
COATB_BPIF1/22-73 FAADDATSQAKAAFDSLTAQATEMSGYAWALVVLVVGATVGIKLFKKFVSRA
#=GR COATB_BPIF1/22-73 SS XX-HHHH--HHHHHH--HHHHHH--HHHHHHHHHHHHHHHHHHHHHHHHHH--
#=GC SS_cons XHHHHHHHHHHHHHHCHHHHHHHCHHHHHHHHHHHHHHHHHHHHHHHHHHC--
#=GC seq_cons AEssss...AptAhDSLpspAT-hIu.sWshVsslVsAsluIKLFKKFsSKA
//
```

This is the seed alignment for the Phage.Coat.Gp8 (PF05371) PFAM entry, downloaded from a now out of date release of PFAM from <http://pfam.sanger.ac.uk/>. We can load this file as follows (assuming it has been saved to disk as "PF05371_seed.sth" in the current working directory):

```
from Bio import AlignIO
alignment = AlignIO.read("PF05371_seed.sth", "stockholm")
print alignment
```

This code will print out a summary of the alignment:

```
SingleLetterAlphabet() alignment with 7 rows and 52 columns
AEPNAATNYATEAMDSLKTQAIDLISQTWPVVTTVVVAGLVIRL...SKA COATB_BPIKE/30-81
AEPNAATNYATEAMDSLKTQAIDLISQTWPVVTTVVVAGLVIKL...SRA Q9TOQ8_BPIKE/1-52
DGTSTATSYATEAMNSLKTQATDLIDQTWPVVTSVAVAGLAIRL...SKA COATB_BPI22/32-83
AEGDDP---AKAAFNSLQASATEYIGYAWAMVVVIVGATIGIKL...SKA COATB_BPM13/24-72
AEGDDP---AKAAFDSLQASATEYIGYAWAMVVVIVGATIGIKL...SKA COATB_BPZJ2/1-49
AEGDDP---AKAAFDSLQASATEYIGYAWAMVVVIVGATIGIKL...SKA Q9TOQ9_BPF1/1-49
FAADDATSQAKAAFDSLTAQATEMSGYAWALVVLVVGATVGIK...SRA COATB_BPIF1/22-73
```

You'll notice in the above output the sequences have been truncated. We could instead write our own code to format this as we please by iterating over the rows as SeqRecord objects:

```

from Bio import AlignIO
alignment = AlignIO.read("PF05371_seed.sth", "stockholm")
print "Alignment length %i" % alignment.get_alignment_length()
for record in alignment:
    print "%s - %s" % (record.seq, record.id)

```

This will give the following output:

```

Alignment length 52
AEPNAATNYATEAMDSLKTQAIDLISQTWPVVTTVVVAGLVIRLFKFFSSKA - COATB_BPIKE/30-81
AEPNAATNYATEAMDSLKTQAIDLISQTWPVVTTVVVAGLVIKLFFKFFVSRA - Q9TOQ8_BPIKE/1-52
DGTSTATSYATEAMNSLKTQATDLIDQTWPVVTSVAVAGLAIRLFKFFSSKA - COATB_BPI22/32-83
AEGDDP---AKAAFNSLQASATEYIGYAWAMVVVIVGATIGIKLFFKFFTSKA - COATB_BPM13/24-72
AEGDDP---AKAAFDSLQASATEYIGYAWAMVVVIVGATIGIKLFFKFFASKA - COATB_BPZJ2/1-49
AEGDDP---AKAAFDSLQASATEYIGYAWAMVVVIVGATIGIKLFFKFFTSKA - Q9TOQ9_BPF1/1-49
FAADDATSAKAAFDSLTAQATEMSGYAWALVVLVVGATVGIKLFKFFVSRA - COATB_BPIF1/22-73

```

You could also use the alignment object's `format` method to show it in a particular file format – see Section 6.2.2 for details.

Did you notice in the raw file above that several of the sequences include database cross-references to the PDB and the associated known secondary structure? Try this:

```

for record in alignment:
    if record.dbxrefs:
        print record.id, record.dbxrefs

```

giving:

```

COATB_BPIKE/30-81 ['PDB; 1if1 ; 1-52;']
COATB_BPM13/24-72 ['PDB; 2cpb ; 1-49;', 'PDB; 2cps ; 1-49;']
Q9TOQ9_BPF1/1-49 ['PDB; 1nh4 A; 1-49;']
COATB_BPIF1/22-73 ['PDB; 1ifk ; 1-50;']

```

To have a look at all the sequence annotation, try this:

```

for record in alignment:
    print record

```

Sanger provide a nice web interface at <http://pfam.sanger.ac.uk/family?acc=PF05371> which will actually let you download this alignment in several other formats. This is what the file looks like in the FASTA file format:

```

>COATB_BPIKE/30-81
AEPNAATNYATEAMDSLKTQAIDLISQTWPVVTTVVVAGLVIRLFKFFSSKA
>Q9TOQ8_BPIKE/1-52
AEPNAATNYATEAMDSLKTQAIDLISQTWPVVTTVVVAGLVIKLFFKFFVSRA
>COATB_BPI22/32-83
DGTSTATSYATEAMNSLKTQATDLIDQTWPVVTSVAVAGLAIRLFKFFSSKA
>COATB_BPM13/24-72
AEGDDP---AKAAFNSLQASATEYIGYAWAMVVVIVGATIGIKLFFKFFTSKA
>COATB_BPZJ2/1-49
AEGDDP---AKAAFDSLQASATEYIGYAWAMVVVIVGATIGIKLFFKFFASKA
>Q9TOQ9_BPF1/1-49
AEGDDP---AKAAFDSLQASATEYIGYAWAMVVVIVGATIGIKLFFKFFTSKA
>COATB_BPIF1/22-73
FAADDATSAKAAFDSLTAQATEMSGYAWALVVLVVGATVGIKLFKFFVSRA

```

Note the website should have an option about showing gaps as periods (dots) or dashes, we've shown dashes above. Assuming you download and save this as file "PF05371_seed.faa" then you can load it with almost exactly the same code:

```
from Bio import AlignIO
alignment = AlignIO.read("PF05371_seed.faa", "fasta")
print alignment
```

All that has changed in this code is the filename and the format string. You'll get the same output as before, the sequences and record identifiers are the same. However, as you should expect, if you check each `SeqRecord` there is no annotation nor database cross-references because these are not included in the FASTA file format.

Note that rather than using the Sanger website, you could have used `Bio.AlignIO` to convert the original Stockholm format file into a FASTA file yourself (see below).

With any supported file format, you can load an alignment in exactly the same way just by changing the format string. For example, use "phylip" for PHYLIP files, "nexus" for NEXUS files or "emboss" for the alignments output by the EMBOSS tools. There is a full listing on the wiki page (<http://biopython.org/wiki/AlignIO>) and in the built in documentation (also [online](#)):

```
>>> from Bio import AlignIO
>>> help(AlignIO)
...
```

6.1.2 Multiple Alignments

The previous section focused on reading files containing a single alignment. In general however, files can contain more than one alignment, and to read these files we must use the `Bio.AlignIO.parse()` function.

Suppose you have a small alignment in PHYLIP format:

```
5      6
Alpha   AACCAAC
Beta    AACCCC
Gamma   ACCAAC
Delta   CCACCA
Epsilon CCAAAC
```

If you wanted to bootstrap a phylogenetic tree using the PHYLIP tools, one of the steps would be to create a set of many resampled alignments using the tool `bootseq`. This would give output something like this, which has been abbreviated for conciseness:

```
5      6
Alpha   AAACCA
Beta    AAACCC
Gamma   ACCCCA
Delta   CCCAAC
Epsilon CCCAAA

5      6
Alpha   AAACAA
Beta    AAACCC
Gamma   ACCCAA
Delta   CCCACC
Epsilon CCCAAA

5      6
```

```

Alpha    AAAAAAC
Beta     AAACCC
Gamma    AACAAC
Delta    CCCCCA
Epsilon  CCCAAC
...
      5      6
Alpha    AAAAACC
Beta     ACCCCC
Gamma    AAAAACC
Delta    CCCCAA
Epsilon  CAAACC

```

If you wanted to read this in using `Bio.AlignIO` you could use:

```

from Bio import AlignIO
alignments = AlignIO.parse("resampled.phy", "phylip")
for alignment in alignments:
    print alignment
    print

```

This would give the following output, again abbreviated for display:

```

SingleLetterAlphabet() alignment with 5 rows and 6 columns
AAACCA Alpha
AAACCC Beta
ACCCCA Gamma
CCCAAC Delta
CCCAAA Epsilon

```

```

SingleLetterAlphabet() alignment with 5 rows and 6 columns
AAACAA Alpha
AAACCC Beta
ACCCAA Gamma
CCCACC Delta
CCCAAA Epsilon

```

```

SingleLetterAlphabet() alignment with 5 rows and 6 columns
AAAAAC Alpha
AAACCC Beta
AACAAC Gamma
CCCCCA Delta
CCCAAC Epsilon

```

...

```

SingleLetterAlphabet() alignment with 5 rows and 6 columns
AAAACC Alpha
ACCCCC Beta
AAAACC Gamma
CCCCAA Delta
CAAACC Epsilon

```

As with the function `Bio.SeqIO.parse()`, using `Bio.AlignIO.parse()` returns an iterator. If you want to keep all the alignments in memory at once, which will allow you to access them in any order, then turn the iterator into a list:

```
from Bio import AlignIO
alignments = list(AlignIO.parse("resampled.phy", "phylip"))
last_align = alignments[-1]
first_align = alignments[0]
```

6.1.3 Ambiguous Alignments

Many alignment file formats can explicitly store more than one alignment, and the division between each alignment is clear. However, when a general sequence file format has been used there is no such block structure. The most common such situation is when alignments have been saved in the FASTA file format. For example consider the following:

```
>Alpha
ACTACGACTAGCTCAG--G
>Beta
ACTACCGCTAGCTCAGAAG
>Gamma
ACTACGGCTAGCACAGAAG
>Alpha
ACTACGACTAGCTCAGG--
>Beta
ACTACCGCTAGCTCAGAAG
>Gamma
ACTACGGCTAGCACAGAAG
```

This could be a single alignment containing six sequences (with repeated identifiers). Or, judging from the identifiers, this is probably two different alignments each with three sequences, which happen to all have the same length.

What about this next example?

```
>Alpha
ACTACGACTAGCTCAG--G
>Beta
ACTACCGCTAGCTCAGAAG
>Alpha
ACTACGACTAGCTCAGG--
>Gamma
ACTACGGCTAGCACAGAAG
>Alpha
ACTACGACTAGCTCAGG--
>Delta
ACTACGGCTAGCACAGAAG
```

Again, this could be a single alignment with six sequences. However this time based on the identifiers we might guess this is three pairwise alignments which by chance have all got the same lengths.

This final example is similar:

```
>Alpha
ACTACGACTAGCTCAG--G
```

```

>XXX
ACTACCGCTAGCTCAGAAG
>Alpha
ACTACGACTAGCTCAGG
>YYY
ACTACGGCAAGCACAGG
>Alpha
--ACTACGAC--TAGCTCAGG
>ZZZ
GGACTACGACAATAGCTCAGG

```

In this third example, because of the differing lengths, this cannot be treated as a single alignment containing all six records. However, it could be three pairwise alignments.

Clearly trying to store more than one alignment in a FASTA file is not ideal. However, if you are forced to deal with these as input files `Bio.AlignIO` can cope with the most common situation where all the alignments have the same number of records. One example of this is a collection of pairwise alignments, which can be produced by the EMBOSS tools `needle` and `water` – although in this situation, `Bio.AlignIO` should be able to understand their native output using “emboss” as the format string.

To interpret these FASTA examples as several separate alignments, we can use `Bio.AlignIO.parse()` with the optional `seq_count` argument which specifies how many sequences are expected in each alignment (in these examples, 3, 2 and 2 respectively). For example, using the third example as the input data:

```

for alignment in AlignIO.parse(handle, "fasta", seq_count=2):
    print "Alignment length %i" % alignment.get_alignment_length()
    for record in alignment:
        print "%s - %s" % (record.seq, record.id)
    print

```

giving:

```

Alignment length 19
ACTACGACTAGCTCAG--G - Alpha
ACTACCGCTAGCTCAGAAG - XXX

```

```

Alignment length 17
ACTACGACTAGCTCAGG - Alpha
ACTACGGCAAGCACAGG - YYY

```

```

Alignment length 21
--ACTACGAC--TAGCTCAGG - Alpha
GGACTACGACAATAGCTCAGG - ZZZ

```

Using `Bio.AlignIO.read()` or `Bio.AlignIO.parse()` without the `seq_count` argument would give a single alignment containing all six records for the first two examples. For the third example, an exception would be raised because the lengths differ preventing them being turned into a single alignment.

If the file format itself has a block structure allowing `Bio.AlignIO` to determine the number of sequences in each alignment directly, then the `seq_count` argument is not needed. If it is supplied, and doesn’t agree with the file contents, an error is raised.

Note that this optional `seq_count` argument assumes each alignment in the file has the same number of sequences. Hypothetically you may come across stranger situations, for example a FASTA file containing several alignments each with a different number of sequences – although I would love to hear of a real world example of this. Assuming you cannot get the data in a nicer file format, there is no straight forward way to deal with this using `Bio.AlignIO`. In this case, you could consider reading in the sequences themselves using `Bio.SeqIO` and batching them together to create the alignments as appropriate.

6.2 Writing Alignments

We've talked about using `Bio.AlignIO.read()` and `Bio.AlignIO.parse()` for alignment input (reading files), and now we'll look at `Bio.AlignIO.write()` which is for alignment output (writing files). This is a function taking three arguments: some `MultipleSeqAlignment` objects (or for backwards compatibility the obsolete `Alignment` objects), a handle or filename to write to, and a sequence format.

Here is an example, where we start by creating a few `MultipleSeqAlignment` objects the hard way (by hand, rather than by loading them from a file). Note we create some `SeqRecord` objects to construct the alignment from.

```
from Bio.Alphabet import generic_dna
from Bio.Seq import Seq
from Bio.SeqRecord import SeqRecord
from Bio.Align import MultipleSeqAlignment

align1 = MultipleSeqAlignment([
    SeqRecord(Seq("ACTGCTAGCTAG", generic_dna), id="Alpha"),
    SeqRecord(Seq("ACT-CTAGCTAG", generic_dna), id="Beta"),
    SeqRecord(Seq("ACTGCTAGDTAG", generic_dna), id="Gamma"),
])

align2 = MultipleSeqAlignment([
    SeqRecord(Seq("GTCAGC-AG", generic_dna), id="Delta"),
    SeqRecord(Seq("GACAGCTAG", generic_dna), id="Epsilon"),
    SeqRecord(Seq("GTCAGCTAG", generic_dna), id="Zeta"),
])

align3 = MultipleSeqAlignment([
    SeqRecord(Seq("ACTAGTACAGCTG", generic_dna), id="Eta"),
    SeqRecord(Seq("ACTAGTACAGCT-", generic_dna), id="Theta"),
    SeqRecord(Seq("-CTACTACAGGTG", generic_dna), id="Iota"),
])

my_alignments = [align1, align2, align3]
```

Now we have a list of `Alignment` objects, we'll write them to a PHYLIP format file:

```
from Bio import AlignIO
AlignIO.write(my_alignments, "my_example.phy", "phylip")
```

And if you open this file in your favourite text editor it should look like this:

```
3 12
Alpha      ACTGCTAGCT AG
Beta       ACT-CTAGCT AG
Gamma      ACTGCTAGDT AG
3 9
Delta      GTCAGC-AG
Epsilon    GACAGCTAG
Zeta       GTCAGCTAG
3 13
Eta        ACTAGTACAG CTG
Theta      ACTAGTACAG CT-
Iota       -CTACTACAG GTG
```

Its more common to want to load an existing alignment, and save that, perhaps after some simple manipulation like removing certain rows or columns.

Suppose you wanted to know how many alignments the `Bio.AlignIO.write()` function wrote to the handle? If your alignments were in a list like the example above, you could just use `len(my_alignments)`, however you can't do that when your records come from a generator/iterator. Therefore as of Biopython 1.49, the `Bio.AlignIO.write()` function returns the number of alignments written to the file.

Note - If you tell the `Bio.AlignIO.write()` function to write to a file that already exists, the old file will be overwritten without any warning.

6.2.1 Converting between sequence alignment file formats

Converting between sequence alignment file formats with `Bio.AlignIO` works in the same way as converting between sequence file formats with `Bio.SeqIO` (Section 5.5.2). We load generally the alignment(s) using `Bio.AlignIO.parse()` and then save them using the `Bio.AlignIO.write()` – or just use the `Bio.AlignIO.convert()` helper function.

For this example, we'll load the PFAM/Stockholm format file used earlier and save it as a Clustal W format file:

```
from Bio import AlignIO
count = AlignIO.convert("PF05371_seed.sth", "stockholm", "PF05371_seed.aln", "clustal")
print "Converted %i alignments" % count
```

Or, using `Bio.AlignIO.parse()` and `Bio.AlignIO.write()`:

```
from Bio import AlignIO
alignments = AlignIO.parse("PF05371_seed.sth", "stockholm")
count = AlignIO.write(alignments, "PF05371_seed.aln", "clustal")
print "Converted %i alignments" % count
```

The `Bio.AlignIO.write()` function expects to be given multiple alignment objects. In the example above we gave it the alignment iterator returned by `Bio.AlignIO.parse()`.

In this case, we know there is only one alignment in the file so we could have used `Bio.AlignIO.read()` instead, but notice we have to pass this alignment to `Bio.AlignIO.write()` as a single element list:

```
from Bio import AlignIO
alignment = AlignIO.read("PF05371_seed.sth", "stockholm")
AlignIO.write([alignment], "PF05371_seed.aln", "clustal")
```

Either way, you should end up with the same new Clustal W format file “PF05371_seed.aln” with the following content:

```
CLUSTAL X (1.81) multiple sequence alignment

COATB_BPIKE/30-81      AEPNAATNYATEAMDSLKTQAIDLISQTPVVTTVVVAGLVIRLFKKFSS
Q9TOQ8_BPIKE/1-52     AEPNAATNYATEAMDSLKTQAIDLISQTPVVTTVVVAGLVIKLFKKFVS
COATB_BPI22/32-83     DGTSTATSYATEAMNSLKTQATDLIDQTWPVVTTSVAVAGLAIRLFKKFSS
COATB_BPM13/24-72     AEGDDP---AKAAFNSLQASATEYIGYAWAMVVVIVGATIGIKLFKKFSS
COATB_BPZJ2/1-49      AEGDDP---AKAAFDSLQASATEYIGYAWAMVVVIVGATIGIKLFKKFAS
Q9TOQ9_BPF1/1-49      AEGDDP---AKAAFDSLQASATEYIGYAWAMVVVIVGATIGIKLFKKFSS
COATB_BPIF1/22-73     FAADDATSQAKAAFDSLTAQATEMSGYAWALVVLVVGATVGIKLFKKFVS

COATB_BPIKE/30-81      KA
```

```

Q9TOQ8_BPIKE/1-52      RA
COATB_BPI22/32-83     KA
COATB_BPM13/24-72     KA
COATB_BPZJ2/1-49      KA
Q9TOQ9_BPF1/1-49      KA
COATB_BPIF1/22-73     RA

```

Alternatively, you could make a PHYLIP format file which we'll name "PF05371_seed.phy":

```

from Bio import AlignIO
AlignIO.convert("PF05371_seed.sth", "stockholm", "PF05371_seed.phy", "phylip")

```

This time the output looks like this:

```

7 52
COATB_BPIK AEPNAATNYA TEAMDSLKTQ AIDLISQTPV VTTTVVAVGL VIRLFKKFSS
Q9TOQ8_BPI AEPNAATNYA TEAMDSLKTQ AIDLISQTPV VTTTVVAVGL VIKLFKKFVS
COATB_BPI2 DGTSTATSYA TEAMNSLKTQ ATDLIDQTPV VVTSVAVAGL AIRLFKKFSS
COATB_BPM1 AEGDDP---A KAAFNSLQAS ATEYIGYAWA MVVVIVGATI GIKLFKKFSS
COATB_BPZJ AEGDDP---A KAAFNSLQAS ATEYIGYAWA MVVVIVGATI GIKLFKKFAS
Q9TOQ9_BPF AEGDDP---A KAAFNSLQAS ATEYIGYAWA MVVVIVGATI GIKLFKKFSS
COATB_BPIF FAADDATSQA KAAFDSLTAQ ATEMSGYAWA LVVLVVGATV GIKLFKKFVS

      KA
      RA
      KA
      KA
      KA
      KA
      RA

```

One of the big handicaps of the PHYLIP alignment file format is that the sequence identifiers are strictly truncated at ten characters. In this example, as you can see the resulting names are still unique - but they are not very readable. In this particular case, there is no clear way to compress the identifiers, but for the sake of argument you may want to assign your own names or numbering system. This following bit of code manipulates the record identifiers before saving the output:

```

from Bio import AlignIO
alignment = AlignIO.read("PF05371_seed.sth", "stockholm")
name_mapping = {}
for i, record in enumerate(alignment):
    name_mapping[i] = record.id
    record.id = "seq%i" % i
print name_mapping

AlignIO.write([alignment], "PF05371_seed.phy", "phylip")

```

This code used a Python dictionary to record a simple mapping from the new sequence system to the original identifier:

```
{0: 'COATB_BPIKE/30-81', 1: 'Q9TOQ8_BPIKE/1-52', 2: 'COATB_BPI22/32-83', ...}
```

Here is the new PHYLIP format output:

7 52

```
seq0      AEPNAATNYA TEAMDSLKTQ AIDLISQTP VTTTVVAGL VIRLFKKFSS
seq1      AEPNAATNYA TEAMDSLKTQ AIDLISQTP VTTTVVAGL VIKLFKKFVS
seq2      DGTSTATSYA TEAMNSLKTQ ATDLIDQTP VVTSVAVAGL AIRLFKKFSS
seq3      AEGDDP---A KAAFNSLQAS ATEYIGYAWA MVVVIVGATI GIKLFKKFVS
seq4      AEGDDP---A KAAFDSLQAS ATEYIGYAWA MVVVIVGATI GIKLFKKFAS
seq5      AEGDDP---A KAAFDSLQAS ATEYIGYAWA MVVVIVGATI GIKLFKKFVS
seq6      FAADDATSQA KAAFDSLTAQ ATEMSGYAWA LVVLVVGATV GIKLFKKFVS
```

```
KA
RA
KA
KA
KA
KA
RA
```

In general, because of the identifier limitation, working with PHYLIP file formats shouldn't be your first choice. Using the PFAM/Stockholm format on the other hand allows you to record a lot of additional annotation too.

6.2.2 Getting your alignment objects as formatted strings

The `Bio.AlignIO` interface is based on handles, which means if you want to get your alignment(s) into a string in a particular file format you need to do a little bit more work (see below). However, you will probably prefer to take advantage of the new `format()` method added to the alignment object in Biopython 1.48. This takes a single mandatory argument, a lower case string which is supported by `Bio.AlignIO` as an output format. For example:

```
from Bio import AlignIO
alignment = AlignIO.read("PF05371_seed.sth", "stockholm")
print alignment.format("clustal")
```

As described in Section 4.5), the `SeqRecord` object has a similar method using output formats supported by `Bio.SeqIO`.

Internally the `format()` method is using the `StringIO` string based handle and calling `Bio.AlignIO.write()`. You can do this in your own code if for example you are using an older version of Biopython:

```
from Bio import AlignIO
from StringIO import StringIO

alignments = AlignIO.parse("PF05371_seed.sth", "stockholm")

out_handle = StringIO()
AlignIO.write(alignments, out_handle, "clustal")
clustal_data = out_handle.getvalue()

print clustal_data
```

6.3 Manipulating Alignments

Now that we've covered loading and saving alignments, we'll look at what else you can do with them. Note that many of these features are new in Biopython 1.54.

First of all, in some senses the alignment objects act like a Python list of SeqRecord objects (the rows). With this model in mind hopefully the actions of len() (the number of rows) and iteration (each row as a SeqRecord) make sense:

```
>>> from Bio import AlignIO
>>> alignment = AlignIO.read("PF05371_seed.sth", "stockholm")
>>> print "Number of rows: %i" % len(alignment)
>>> for record in alignment:
...     print "%s - %s" % (record.seq, record.id)
```

You can also use the list-like append and extend methods to add more rows to the alignment (as SeqRecord objects). Keeping the list metaphor in mind, simple slicing of the alignment should also make sense - it selects some of the rows giving back another alignment object:

```
>>> print alignment
SingleLetterAlphabet() alignment with 7 rows and 52 columns
AEPNAATNYATEAMDSLKTQAIDLISQTPVVTTVVVAGLVIRL...SKA COATB_BPIKE/30-81
AEPNAATNYATEAMDSLKTQAIDLISQTPVVTTVVVAGLVIKL...SRA Q9TOQ8_BPIKE/1-52
DGTSTATSYATEAMNSLKTQATDLIDQTPVVTSVAVAGLAIRL...SKA COATB_BPI22/32-83
AEGDDP---AKAAFNSLQASATEYIGYAWAMVVVIVGATIGIKL...SKA COATB_BPM13/24-72
AEGDDP---AKAAFDSLQASATEYIGYAWAMVVVIVGATIGIKL...SKA COATB_BPZJ2/1-49
AEGDDP---AKAAFDSLQASATEYIGYAWAMVVVIVGATIGIKL...SKA Q9TOQ9_BPFD/1-49
FAADDATSQAKAAFDSLTAQATEMSGYAWALVVLVVGATVGIKL...SRA COATB_BPIF1/22-73
>>> print alignment[3:7]
SingleLetterAlphabet() alignment with 4 rows and 52 columns
AEGDDP---AKAAFNSLQASATEYIGYAWAMVVVIVGATIGIKL...SKA COATB_BPM13/24-72
AEGDDP---AKAAFDSLQASATEYIGYAWAMVVVIVGATIGIKL...SKA COATB_BPZJ2/1-49
AEGDDP---AKAAFDSLQASATEYIGYAWAMVVVIVGATIGIKL...SKA Q9TOQ9_BPFD/1-49
FAADDATSQAKAAFDSLTAQATEMSGYAWALVVLVVGATVGIKL...SRA COATB_BPIF1/22-73
```

What if you wanted to select by column? Those of you who have used the NumPy matrix or array objects won't be surprised at this - you use a double index.

```
>>> print alignment[2,6]
T
```

Using two integer indices pulls out a single letter, short hand for this:

```
>>> print alignment[2].seq[6]
T
```

You can pull out a single column as a Seq record like this:

```
>>> print alignment[:,6]
TTT---T
```

You can also select a range of columns. For example, to pick out those same three rows we extracted earlier, but take just their first six columns:

```
>>> print alignment[3:6,:6]
SingleLetterAlphabet() alignment with 3 rows and 6 columns
AEGDDP COATB_BPM13/24-72
AEGDDP COATB_BPZJ2/1-49
AEGDDP Q9TOQ9_BPFD/1-49
```

Leaving the first index as : means take all the rows:

```
>>> print alignment[:, :6]
SingleLetterAlphabet() alignment with 7 rows and 6 columns
AEPNAA COATB_BPIKE/30-81
AEPNAA Q9TOQ8_BPIKE/1-52
DGTSTA COATB_BPI22/32-83
AEGDDP COATB_BPM13/24-72
AEGDDP COATB_BPZJ2/1-49
AEGDDP Q9TOQ9_BPF1/1-49
FAADDA COATB_BPIF1/22-73
```

This brings us to a neat way to remove a section. Notice columns 7, 8 and 9 which are gaps in three of the seven sequences:

```
>>> print alignment[:, 6:9]
SingleLetterAlphabet() alignment with 7 rows and 3 columns
TNY COATB_BPIKE/30-81
TNY Q9TOQ8_BPIKE/1-52
TSY COATB_BPI22/32-83
--- COATB_BPM13/24-72
--- COATB_BPZJ2/1-49
--- Q9TOQ9_BPF1/1-49
TSQ COATB_BPIF1/22-73
```

Again, you can slice to get everything after the ninth column:

```
>>> print alignment[:, 9:]
SingleLetterAlphabet() alignment with 7 rows and 43 columns
ATEAMDSLKTQAIDLISQTPVVTTVVVAGLVIRLFKKFSSKA COATB_BPIKE/30-81
ATEAMDSLKTQAIDLISQTPVVTTVVVAGLVIKLFKKFVSRA Q9TOQ8_BPIKE/1-52
ATEAMNSLKTQATDLIDQTPVVTSVAVAGLAIRLFKKFSSKA COATB_BPI22/32-83
AKAAFNSLQASATEYIGYAWAMVVVIVGATIGIKLFKKFTSKA COATB_BPM13/24-72
AKAAFDSLQASATEYIGYAWAMVVVIVGATIGIKLFKKFASKA COATB_BPZJ2/1-49
AKAAFDSLQASATEYIGYAWAMVVVIVGATIGIKLFKKFTSKA Q9TOQ9_BPF1/1-49
AKAAFDSLTAQATEMSGYAWALVVLVVGATVGIKLFKKFVSRA COATB_BPIF1/22-73
```

Now, the interesting thing is that addition of alignment objects works by column. This lets you do this as a way to remove a block of columns:

```
>>> edited = alignment[:, :6] + alignment[:, 9:]
>>> print edited
SingleLetterAlphabet() alignment with 7 rows and 49 columns
AEPNAAATEAMDSLKTQAIDLISQTPVVTTVVVAGLVIRLFKKFSSKA COATB_BPIKE/30-81
AEPNAAATEAMDSLKTQAIDLISQTPVVTTVVVAGLVIKLFKKFVSRA Q9TOQ8_BPIKE/1-52
DGTSTAATEAMNSLKTQATDLIDQTPVVTSVAVAGLAIRLFKKFSSKA COATB_BPI22/32-83
AEGDDPAKAANSLQASATEYIGYAWAMVVVIVGATIGIKLFKKFTSKA COATB_BPM13/24-72
AEGDDPAKAANSLQASATEYIGYAWAMVVVIVGATIGIKLFKKFASKA COATB_BPZJ2/1-49
AEGDDPAKAANSLQASATEYIGYAWAMVVVIVGATIGIKLFKKFTSKA Q9TOQ9_BPF1/1-49
FAADDAKAANSLTAQATEMSGYAWALVVLVVGATVGIKLFKKFVSRA COATB_BPIF1/22-73
```

Another common use of alignment addition would be to combine alignments for several different genes into a meta-alignment. Watch out though - the identifiers need to match up (see Section ?? for how adding SeqRecord objects works). You may find it helpful to first sort the alignment rows alphabetically by id:

```

>>> edited.sort()
>>> print edited
SingleLetterAlphabet() alignment with 7 rows and 49 columns
DGTSTAATEAMNSLKTQATDLIDQTPVVVTSVAVAGLAIRLFKKFSSKA COATB_BPI22/32-83
FAADDAAKAAFDSLTAQATEMSGYAWALVVLVVGATVGIKLFKKFVSRA COATB_BPIF1/22-73
AEPNAAATEAMDSLKTQAIDLISQTWPVVVTVVAVAGLVIRLFKKFSSKA COATB_BPIKE/30-81
AEGDDPAKAAFNSLQASATEYIGYAWAMVVVIVGATIGIKLFKKFSSKA COATB_BPM13/24-72
AEGDDPAKAAFNSLQASATEYIGYAWAMVVVIVGATIGIKLFKKFSSKA COATB_BPZJ2/1-49
AEPNAAATEAMDSLKTQAIDLISQTWPVVVTVVAVAGLVIKLFKKFVSRA Q9TOQ8_BPIKE/1-52
AEGDDPAKAAFNSLQASATEYIGYAWAMVVVIVGATIGIKLFKKFSSKA Q9TOQ9_BPF1/1-49

```

Note that you can only add two alignments together if they have the same number of rows.

6.4 Alignment Tools

There are *lots* of algorithms out there for aligning sequences, both pairwise alignments and multiple sequence alignments. These calculations are relatively slow, and you generally wouldn't want to write such an algorithm in Python. Instead, you can use Biopython to invoke a command line tool on your behalf. Normally you would:

1. Prepare an input file of your unaligned sequences, typically this will be a FASTA file which you might create using `Bio.SeqIO` (see Chapter 5).
2. Call the command line tool to process this input file, typically via one of Biopython's command line wrappers (which we'll discuss here).
3. Read the output from the tool, i.e. your aligned sequences, typically using `Bio.AlignIO` (see earlier in this chapter).

All the command line wrappers we're going to talk about in this chapter follow the same style. You create a command line object specifying the options (e.g. the input filename and the output filename), then invoke this command line via a Python operating system call (e.g. using the `subprocess` module).

Most of these wrappers are defined in the `Bio.Align.Applications` module:

```

>>> import Bio.Align.Applications
>>> dir(Bio.Align.Applications)
...
['ClustalwCommandline', 'DialignCommandline', 'MafftCommandline', 'MuscleCommandline',
'PrankCommandline', 'ProbconsCommandline', 'TcoffeeCommandline' ...]

```

(Ignore the entries starting with an underscore – these have special meaning in Python.) The module `Bio.Emboss.Applications` has wrappers for some of the [EMBOSS suite](#), including `needle` and `water`, which are described below in Section 6.4.5, and wrappers for the EMBOSS packaged versions of the PHYLIP tools (which EMBOSS refer to as one of their EMBASSY packages - third party tools with an EMBOSS style interface). We won't explore all these alignment tools here in the section, just a sample, but the same principles apply.

6.4.1 ClustalW

ClustalW is a popular command line tool for multiple sequence alignment (there is also a graphical interface called ClustalX). Biopython's `Bio.Align.Applications` module has a wrapper for this alignment tool (and several others).

Before trying to use ClustalW from within Python, you should first try running the ClustalW tool yourself by hand at the command line, to familiarise yourself the other options. You'll find the Biopython wrapper is very faithful to the actual command line API:

```
>>> from Bio.Align.Applications import ClustalwCommandline
>>> help(ClustalwCommandline)
...
```

For the most basic usage, all you need is to have a FASTA input file, such as [opuntia.fasta](#) (available online or in the Doc/examples subdirectory of the Biopython source code). This is a small FASTA file containing seven prickly-pear DNA sequences (from the cactus family *Opuntia*).

By default ClustalW will generate an alignment and guide tree file with names based on the input FASTA file, in this case `opuntia.aln` and `opuntia.dnd`, but you can override this or make it explicit:

```
>>> from Bio.Align.Applications import ClustalwCommandline
>>> cline = ClustalwCommandline("clustalw2", infile="opuntia.fasta")
>>> print cline
clustalw2 -infile=opuntia.fasta
```

Notice here we have given the executable name as `clustalw2`, indicating we have version two installed, which has a different filename to version one (`clustalw`, the default). Fortunately both versions support the same set of arguments at the command line (and indeed, should be functionally identical).

You may find that even though you have ClustalW installed, the above command doesn't work – you may get a message about “command not found” (especially on Windows). This indicated that the ClustalW executable is not on your PATH (an environment variable, a list of directories to be searched). You can either update your PATH setting to include the location of your copy of ClustalW tools (how you do this will depend on your OS), or simply type in the full path of the tool. You can also tell Biopython the full path to the tool, for example:

```
>>> import os
>>> from Bio.Align.Applications import ClustalwCommandline
>>> clustalw_exe = r"C:\Program Files\new clustal\clustalw2.exe"
>>> assert os.path.isfile(clustalw_exe), "Clustal W executable missing"
>>> cline = ClustalwCommandline(clustalw_exe, infile="opuntia.fasta")
```

Remember, in Python a default string `\n` and `\t` translate as a new line and a tab – which is why we're put a letter “r” at the start for a raw string that isn't translated in this way. This is generally good practice when specifying a Windows style file name.

You can now run this command line, and in Python the recommended way to run another program is to use the `subprocess` module. This replaces older options like the `os.system()` and the `os.popen*` functions.

Now, at this point it helps to know about how command line tools “work”. When you run a tool at the command line, it will often print text output directly to screen. This text can be captured or redirected, via two “pipes”, called standard output (the normal results) and standard error (for error messages and debug messages). There is also standard input, which is any text fed into the tool. These names get shortened to `stdin`, `stdout` and `stderr`. When the tool finished, it has a return code (an integer), which by convention is zero for success.

Now let's try an example. Unfortunately there are some subtle differences depending on your Operating System (e.g. Windows versus Unix) and how you are running Python (e.g. at the command line, or in IDLE). You may see a second terminal window appear while ClustalW works. You may see the ClustalW output appear at your Python prompt.

```
>>> import sys
>>> import subprocess
>>> return_code = subprocess.call(str(cline), shell=(sys.platform!="win32"))
...
>>> print return_code
0
```

In the case of ClustlW, when run at the command line all the important output is written directly to the output files. Everything printed to screen while you wait (via stdout or stderr) is boring and can be ignored (assuming it worked). You can explicitly tell ClustalW to send this output to “dev null”, a kind of black hole for command line tool output:

```
>>> import os
>>> import sys
>>> import subprocess
>>> return_code = subprocess.call(str(cline),
...                               stdout = open(os.devnull),
...                               stderr = open(os.devnull),
...                               shell=(sys.platform!="win32"))
>>> print return_code
0
```

This time ClustalW should be “quiet”, because all its terminal output has been discarded. What we care about are the two output files, the alignment and the guide tree. We didn’t tell ClustalW what filenames to use, but it defaults to picking names based on the input file. In this case the output should be in the file `opuntia.aln`. You should be able to work out how to read in the alignment using `Bio.AlignIO` by now:

```
>>> from Bio import AlignIO
>>> align = AlignIO.read("opuntia.aln", "clustal")
>>> print align
SingleLetterAlphabet() alignment with 7 rows and 906 columns
TATACATTAAGAAGGGGGATGCGGATAAATGGAAAGGCGAAAG...AGA gi|6273285|gb|AF191659.1|AF191
TATACATTAAGAAGGGGGATGCGGATAAATGGAAAGGCGAAAG...AGA gi|6273284|gb|AF191658.1|AF191
TATACATTAAGAAGGGGGATGCGGATAAATGGAAAGGCGAAAG...AGA gi|6273287|gb|AF191661.1|AF191
TATACATAAGAAGGGGGATGCGGATAAATGGAAAGGCGAAAG...AGA gi|6273286|gb|AF191660.1|AF191
TATACATTAAGGAGGGGGATGCGGATAAATGGAAAGGCGAAAG...AGA gi|6273290|gb|AF191664.1|AF191
TATACATTAAGGAGGGGGATGCGGATAAATGGAAAGGCGAAAG...AGA gi|6273289|gb|AF191663.1|AF191
TATACATTAAGGAGGGGGATGCGGATAAATGGAAAGGCGAAAG...AGA gi|6273291|gb|AF191665.1|AF191
```

In case you are interested (and this is an aside from the main thrust of this chapter), the `opuntia.dnd` file ClustalW creates is just a standard Newick tree file, and `Bio.Nexus` can parse these. You can either parse the file directly (as though it were a light weight NEXUS file), or just go directly to a tree object:

```
>>> from Bio.Nexus import Trees
>>> tree_string = open("opuntia.dnd").read()
>>> tree = Trees.Tree(tree_string)
>>> print tree
tree a_tree = ((gi|6273291|gb|AF191665.1|AF191665,(gi|6273290|gb|AF191664.1|AF191664,
gi|6273289|gb|AF191663.1|AF191663)),(gi|6273287|gb|AF191661.1|AF191661,
gi|6273286|gb|AF191660.1|AF191660),(gi|6273285|gb|AF191659.1|AF191659,
gi|6273284|gb|AF191658.1|AF191658));
>>> print tree.display()
#          taxon      prev      succ      brlen blen (sum) support comment
0          -         None [1, 6, 9]      0.0      0.0      -      -
1          -         0      [2, 3]      0.0077      0.0077      -      -
2 gi|6273291|gb|AF191665.1|AF191665      1      []      0.00418      0.01188      -      -
3          -         1      [4, 5]      0.00083      0.00853      -      -
4 gi|6273290|gb|AF191664.1|AF191664      3      []      0.00189      0.01042      -      -
5 gi|6273289|gb|AF191663.1|AF191663      3      []      0.00145      0.00998      -      -
6          -         0      [7, 8]      0.00014      0.00014      -      -
```

```

7 gi|6273287|gb|AF191661.1|AF191661      6      []  0.00489  0.00503  -      -
8 gi|6273286|gb|AF191660.1|AF191660    6      []  0.00295  0.00309  -      -
9                                     0 [10, 11] 0.00125  0.00125  -      -
10 gi|6273285|gb|AF191659.1|AF191659   9      []  0.00094  0.00219  -      -
11 gi|6273284|gb|AF191658.1|AF191658   9      []  0.00018  0.00143  -      -

```

```

Root: 0
None

```

The spacing has been adjusted here for display purposes. The tree object is actually pretty powerful! Have a look at the list of methods with `dir(tree)` to get a hint of this...

6.4.2 MUSCLE

MUSCLE is a more recent multiple sequence alignment tool than ClustalW, and Biopython also has a wrapper for it under the `Bio.Align.Applications` module. As before, we recommend you try using MUSCLE from the command line before trying it from within Python, as the Biopython wrapper is very faithful to the actual command line API:

```

>>> from Bio.Align.Applications import MuscleCommandline
>>> help(MuscleCommandline)
...

```

For the most basic usage, all you need is to have a FASTA input file, such as [opuntia.fasta](#) (available online or in the `Doc/examples` subdirectory of the Biopython source code). You can then tell MUSCLE to read in this FASTA file, and write the alignment to an output file:

```

>>> from Bio.Align.Applications import MuscleCommandline
>>> cline = MuscleCommandline(input="opuntia.fasta", out="opuntia.txt")
>>> print cline
muscle -in opuntia.fasta -out opuntia.txt

```

Note that MUSCLE uses “-in” and “-out” but in Biopython we have to use “input” and “out” as the keyword arguments or property names. This is because “in” is a reserved word in Python.

By default MUSCLE will output the alignment as a FASTA file (using gapped sequences). The `Bio.AlignIO` module should be able to read this alignment using `format="fasta"`. You can also ask for ClustalW-like output:

```

>>> from Bio.Align.Applications import MuscleCommandline
>>> cline = MuscleCommandline(input="opuntia.fasta", out="opuntia.aln", clw=True)
>>> print cline
muscle -in opuntia.fasta -out opuntia.aln -clw

```

Or, strict ClustalW output where the original ClustalW header line is used for maximum compatibility:

```

>>> from Bio.Align.Applications import MuscleCommandline
>>> cline = MuscleCommandline(input="opuntia.fasta", out="opuntia.aln", clwstrict=True)
>>> print cline
muscle -in opuntia.fasta -out opuntia.aln -clwstrict

```

The `Bio.AlignIO` module should be able to read these alignments using `format="clustal"`.

MUSCLE can also output in GCG MSF format (using the `msf` argument), but Biopython can’t currently parse that, or using HTML which would give a human readable web page (not suitable for parsing).

You can also set the other optional parameters, for example the maximum number of iterations. See the built in help for details.

You would then run MUSCLE command line string as described above for ClustalW, and parse the output using `Bio.AlignIO` to get an alignment object.

6.4.3 MUSCLE using stdout

Using a MUSCLE command line as in the examples above will write the alignment to a file. This means there will be no important information written to the standard out (stdout) or standard error (stderr) handles. However, by default MUSCLE will write the alignment to standard output (stdout). We can take advantage of this to avoid having a temporary output file! For example:

```
>>> from Bio.Align.Applications import MuscleCommandline
>>> cline = MuscleCommandline(input="opuntia.fasta")
>>> print cline
muscle -in opuntia.fasta
```

Now, let's run this and capture the output as handles. Remember that MUSCLE defaults to using FASTA as the output format:

```
>>> import subprocess
>>> child = subprocess.Popen(str(cline),
...                           stdout=subprocess.PIPE,
...                           stderr=subprocess.PIPE,
...                           shell=(sys.platform!="win32"))
>>> from Bio import AlignIO
>>> align = AlignIO.read(child.stdout, "fasta")
>>> print align
SingleLetterAlphabet() alignment with 7 rows and 906 columns
TATACATTAAGGAGGGGGATGCGGATAAATGGAAAGGCGAAAAG...AGA gi|6273289|gb|AF191663.1|AF191663
TATACATTAAGGAGGGGGATGCGGATAAATGGAAAGGCGAAAAG...AGA gi|6273291|gb|AF191665.1|AF191665
TATACATTAAGGAGGGGGATGCGGATAAATGGAAAGGCGAAAAG...AGA gi|6273290|gb|AF191664.1|AF191664
TATACATTAAGAAGGGGGATGCGGATAAATGGAAAGGCGAAAAG...AGA gi|6273287|gb|AF191661.1|AF191661
TATACATAAAGAAGGGGGATGCGGATAAATGGAAAGGCGAAAAG...AGA gi|6273286|gb|AF191660.1|AF191660
TATACATTAAGAAGGGGGATGCGGATAAATGGAAAGGCGAAAAG...AGA gi|6273285|gb|AF191659.1|AF191659
TATACATTAAGAAGGGGGATGCGGATAAATGGAAAGGCGAAAAG...AGA gi|6273284|gb|AF191658.1|AF191658
```

6.4.4 MUSCLE using stdin and stdout

We don't actually *need* to have our FASTA input sequences prepared in a file, because by default MUSCLE will read in the input sequence from standard input!

First, we'll need some unaligned sequences in memory as `SeqRecord` objects. For this demonstration I'm going to use a filtered version of the original FASTA file (using a generator expression), taking just six of the seven sequences:

```
>>> from Bio import SeqIO
>>> records = (r for r in SeqIO.parse("opuntia.fasta", "fasta") if len(r) < 900)
```

Then we create the MUSCLE command line, leaving the input and output to their defaults (stdin and stdout). I'm also going to ask for strict ClustalW format as for the output.

```
>>> from Bio.Align.Applications import MuscleCommandline
>>> cline = MuscleCommandline(clwstrict=True)
>>> print cline
muscle -clwstrict
```

Now comes the clever bit using the `subprocess` module, stdin and stdout:

```
>>> import subprocess
>>> import sys
>>> child = subprocess.Popen(str(cline),
...                           stdin=subprocess.PIPE,
...                           stdout=subprocess.PIPE,
...                           stderr=subprocess.PIPE,
...                           shell=(sys.platform!="win32"))
```

That should start MUSCLE, but it will be sitting waiting for its FASTA input sequences, which we must supply via its stdin handle:

```
>>> SeqIO.write(records, child.stdin, "fasta")
6
>>> child.stdin.close()
```

After writing the six sequences to the handle, MUSCLE will still be waiting to see if that is all the FASTA sequences or not – so we must signal that this is all the input data by closing the handle. At that point MUSCLE should start to run, and we can ask for the output:

```
>>> from Bio import AlignIO
>>> align = AlignIO.read(child.stdout, "clustal")
>>> print align
SingleLetterAlphabet() alignment with 6 rows and 900 columns
TATACATTA AAGAGGGGGATGCGGATAAAATGGAAAGGCGAAAG...AGA gi|6273290|gb|AF191664.1|AF19166
TATACATTA AAGAGGGGGATGCGGATAAAATGGAAAGGCGAAAG...AGA gi|6273289|gb|AF191663.1|AF19166
TATACATTA AAGAAGGGGGATGCGGATAAAATGGAAAGGCGAAAG...AGA gi|6273287|gb|AF191661.1|AF19166
TATACATAA AAGAAGGGGGATGCGGATAAAATGGAAAGGCGAAAG...AGA gi|6273286|gb|AF191660.1|AF19166
TATACATTA AAGAAGGGGGATGCGGATAAAATGGAAAGGCGAAAG...AGA gi|6273285|gb|AF191659.1|AF19165
TATACATTA AAGAAGGGGGATGCGGATAAAATGGAAAGGCGAAAG...AGA gi|6273284|gb|AF191658.1|AF19165
```

Wow! There we are with a new alignment of just the six records, without having created a temporary FASTA input file, or a temporary alignment output file. However, a word of caution: Dealing with errors with this style of calling external programs is much more complicated. It also becomes far harder to diagnose problems, because you can't try running MUSCLE manually outside of Biopython (because you don't have the input file to supply). There can also be subtle cross platform issues (e.g. Windows versus Linux), and how you run your script can have an impact (e.g. at the command line, from IDLE or an IDE, or as a GUI script). These are all generic Python issues though, and not specific to Biopython.

6.4.5 EMBOSS needle and water

The **EMBOSS** suite includes the **water** and **needle** tools for Smith-Waterman algorithm local alignment, and Needleman-Wunsch global alignment. The tools share the same style interface, so switching between the two is trivial – we'll just use **needle** here.

Suppose you want to do a global pairwise alignment between two sequences, prepared in FASTA format as follows:

```
>HBA_HUMAN
MVLSPADKTNVKAAWGKVGVAHAGEYGAEALERMFSLFPTTKTYFPHFDLSHGSAQVKGHG
KKVADALTNVAHVDDMPNALSALSDLHAHKLRVDPVNFKLLSHCLLVTLAAHLPAEFTP
AVHASLDKFLASVSTVLTSKYR
```

in a file `alpha.fasta`, and secondly in a file `beta.fasta`:

```
>HBB_HUMAN
MVHLTPEEKSAVTALWGKVVNDEVGGEALGRLLVVYPWTQRFFESFGDLSTPDAVMGNPK
VKAHGKKVLGAFSDGLAHLADLNKGTFFATLSELHCDKLHVDPENFRLGQVLCVLAHFFG
KEFTPPVQAAYQKVVAGVANALAHKYH
```

Let's start by creating a complete `needle` command line object in one go:

```
>>> from Bio.Emboss.Applications import NeedleCommandline
>>> cline = NeedleCommandline(asequence="alpha.faa", bsequence="beta.faa",
...                             gapopen=10, gapextend=0.5, outfile="needle.txt")
>>> print cline
needle -outfile=needle.txt -asequence=alpha.faa -bsequence=beta.faa -gapopen=10 -gapextend=0.5
```

Why not try running this by hand at the command prompt? You should see it does a pairwise comparison and records the output in the file `needle.txt` (in the default EMBOSS alignment file format).

Even if you have EMBOSS installed, running this command may not work – you might get a message about “command not found” (especially on Windows). This probably means that the EMBOSS tools are not on your `PATH` environment variable. You can either update your `PATH` setting, or simply tell Biopython the full path to the tool, for example:

```
>>> from Bio.Emboss.Applications import NeedleCommandline
>>> cline = NeedleCommandline(r"C:\EMBOSS\needle.exe",
...                             asequence="alpha.faa", bsequence="beta.faa",
...                             gapopen=10, gapextend=0.5, outfile="needle.txt")
```

Remember in Python that for a default string `\n` or `\t` means a new line or a tab – which is why we're put a letter “r” at the start for a raw string.

At this point it might help to try running the EMBOSS tools yourself by hand at the command line, to familiarise yourself the other options and compare them to the Biopython help text:

```
>>> from Bio.Emboss.Applications import NeedleCommandline
>>> help(NeedleCommandline)
...

```

Note that you can also specify (or change or look at) the settings like this:

```
>>> from Bio.Emboss.Applications import NeedleCommandline
>>> cline = NeedleCommandline()
>>> cline.asequence="alpha.faa"
>>> cline.bsequence="beta.faa"
>>> cline.gapopen=10
>>> cline.gapextend=0.5
>>> cline.outfile="needle.txt"
>>> print cline
needle -outfile=needle.txt -asequence=alpha.faa -bsequence=beta.faa -gapopen=10 -gapextend=0.5
>>> print cline.outfile
needle.txt
```

Next we want to use Python to run this command for us. As explained above, for full control, we recommend you use the built in Python `subprocess` module. For simple usage the `subprocess.call()` wrapper function usually suffices:

```

>>> import subprocess
>>> return_code = subprocess.call(str(cline), shell=(sys.platform!="win32"))
Needleman-Wunsch global alignment of two sequences
>>> print return_code
0

```

In the above, all we really care about is that the return code is zero (success). If you want to hide the message EMBOSS prints out, then (as in the ClustalW example above) send the stdout and stderr to dev null, or just set the EMBOSS `auto` argument to True.

Next we can load the output file with `Bio.AlignIO` as discussed earlier in this chapter, as the `emboss` format:

```

>>> from Bio import AlignIO
>>> align = AlignIO.read("needle.txt", "emboss")
>>> print align
SingleLetterAlphabet() alignment with 2 rows and 149 columns
MV-LSPADKTNVKAAWGKVGAGHAGEYGAEALERMFLSFPTTKTY...KYR HBA_HUMAN
MVHLTPEEKSAVTALWGKV--NVDEVGGEALGRLLVVYPWTQRF...KYH HBB_HUMAN

```

In this example, we told EMBOSS to write the output to a file, but you *can* tell it to write the output to stdout instead (useful if you don't want a temporary output file to get rid of), and also read the input from stdin (just like in the MUSCLE example in the section above).

This has only scratched the surface of what you can do with `needle` and `water`. One useful trick is that the second file can contain multiple sequences (say five), and then EMBOSS will do five pairwise alignments.

Note - Biopython includes its own pairwise alignment code in the `Bio.pairwise2` module (written in C for speed, but with a pure Python fallback available too). This doesn't work with alignment objects, so we have not covered it within this chapter. See the module's docstring (built in help) for details.

Chapter 7

BLAST

Hey, everybody loves BLAST right? I mean, geez, how can get it get any easier to do comparisons between one of your sequences and every other sequence in the known world? But, of course, this section isn't about how cool BLAST is, since we already know that. It is about the problem with BLAST – it can be really difficult to deal with the volume of data generated by large runs, and to automate BLAST runs in general.

Fortunately, the Biopython folks know this only too well, so they've developed lots of tools for dealing with BLAST and making things much easier. This section details how to use these tools and do useful things with them.

Dealing with BLAST can be split up into two steps, both of which can be done from within Biopython. Firstly, running BLAST for your query sequence(s), and getting some output. Secondly, parsing the BLAST output in Python for further analysis.

Your first introduction to running BLAST was probably via the NCBI web-service. In fact, there are lots of ways you can run BLAST, which can be categorised several ways. The most important distinction is running BLAST locally (on your own machine), and running BLAST remotely (on another machine, typically the NCBI servers). We're going to start this chapter by invoking the NCBI online BLAST service from within a Python script.

7.1 Running BLAST over the Internet

We use the function `qblast()` in the `Bio.Blast.NCBIWWW` module call the online version of BLAST. This has three non-optional arguments:

- The first argument is the blast program to use for the search, as a lower case string. The options and descriptions of the programs are available at http://www.ncbi.nlm.nih.gov/BLAST/blast_program.html. Currently `qblast` only works with `blastn`, `blastp`, `blastx`, `tblast` and `tblastx`.
- The second argument specifies the databases to search against. Again, the options for this are available on the NCBI web pages at http://www.ncbi.nlm.nih.gov/BLAST/blast_databases.html.
- The third argument is a string containing your query sequence. This can either be the sequence itself, the sequence in fasta format, or an identifier like a GI number.

The `qblast` function also take a number of other option arguments which are basically analogous to the different parameters you can set on the BLAST web page. We'll just highlight a few of them here:

- The `qblast` function can return the BLAST results in various formats, which you can choose with the optional `format_type` keyword: "HTML", "Text", "ASN.1", or "XML". The default is "XML", as that is the format expected by the parser, described in section 7.3 below.
- The argument `expect` sets the expectation or e-value threshold.

For more about the optional BLAST arguments, we refer you to the NCBI's own documentation, or that built into Biopython:

```
>>> from Bio.Blast import NCBIWWW
>>> help(NCBIWWW.qblast)
```

For example, if you have a nucleotide sequence you want to search against the non-redundant database using BLASTN, and you know the GI number of your query sequence, you can use:

```
>>> from Bio.Blast import NCBIWWW
>>> result_handle = NCBIWWW.qblast("blastn", "nr", "8332116")
```

Alternatively, if we have our query sequence already in a FASTA formatted file, we just need to open the file and read in this record as a string, and use that as the query argument:

```
>>> from Bio.Blast import NCBIWWW
>>> fasta_string = open("m_cold.fasta").read()
>>> result_handle = NCBIWWW.qblast("blastn", "nr", fasta_string)
```

We could also have read in the FASTA file as a `SeqRecord` and then supplied just the sequence itself:

```
>>> from Bio.Blast import NCBIWWW
>>> from Bio import SeqIO
>>> record = SeqIO.read(open("m_cold.fasta"), format="fasta")
>>> result_handle = NCBIWWW.qblast("blastn", "nr", record.seq)
```

Supplying just the sequence means that BLAST will assign an identifier for your sequence automatically. You might prefer to use the `SeqRecord` object's `format` method to make a fasta string (which will include the existing identifier):

```
>>> from Bio.Blast import NCBIWWW
>>> from Bio import SeqIO
>>> record = SeqIO.read(open("m_cold.fasta"), format="fasta")
>>> result_handle = NCBIWWW.qblast("blastn", "nr", record.format("fasta"))
```

This approach makes more sense if you have your sequence(s) in a non-FASTA file format which you can extract using `Bio.SeqIO` (see Chapter 5).

Whatever arguments you give the `qblast()` function, you should get back your results in a handle object (by default in XML format). The next step would be to parse the XML output into Python objects representing the search results (Section 7.3), but you might want to save a local copy of the output file first. I find this especially useful when debugging my code that extracts info from the BLAST results (because re-running the online search is slow and wastes the NCBI computer time).

We need to be a bit careful since we can use `result_handle.read()` to read the BLAST output only once – calling `result_handle.read()` again returns an empty string.

```
>>> save_file = open("my_blast.xml", "w")
>>> save_file.write(result_handle.read())
>>> save_file.close()
>>> result_handle.close()
```

After doing this, the results are in the file `my_blast.xml` and the original handle has had all its data extracted (so we closed it). However, the `parse` function of the BLAST parser (described in 7.3) takes a file-handle-like object, so we can just open the saved file for input:

```
>>> result_handle = open("my_blast.xml")
```

Now that we've got the BLAST results back into a handle again, we are ready to do something with them, so this leads us right into the parsing section (see Section 7.3 below). You may want to jump ahead to that now . . .

7.2 Running BLAST locally

7.2.1 Introduction

Running BLAST locally (as opposed to over the internet, see Section 7.1) has at least major two advantages:

- Local BLAST may be faster than BLAST over the internet;
- Local BLAST allows you to make your own database to search for sequences against.

Dealing with proprietary or unpublished sequence data can be another reason to run BLAST locally. You may not be allowed to redistribute the sequences, so submitting them to the NCBI as a BLAST query would not be an option.

Unfortunately, there are some major drawbacks too – installing all the bits and getting it setup right takes some effort:

- Local BLAST requires command line tools to be installed.
- Local BLAST requires (large) BLAST databases to be setup (and potentially kept up to date).

To further confuse matters there are at least four different standalone BLAST packages, and there are also other tools which can produce imitation BLAST output files, such as BLAT.

7.2.2 Standalone NCBI “legacy” BLAST

NCBI “legacy” BLAST included command line tools `blastall`, `blastpgp` and `rpsblast`. This is probably the most widely used standalone BLAST tool at the moment.

The `Bio.Blast.Applications` module has wrappers for the “legacy” NCBI BLAST tools like `blastall`, `blastpgp` and `rpsblast`, and there are also helper functions in `Bio.Blast.NCBISTandalone`. These are now considered obsolete, and will be deprecated and eventually removed from Biopython as the NCBI move over to the replacement BLAST+ suite.

To try and avoid confusion, we will not cover calling these old tools from Biopython in this tutorial. Have a look at the older edition of this tutorial included with Biopython 1.52 if you are curious.

7.2.3 Standalone NCBI BLAST+

NCBI “new” BLAST+ was released in 2009. This replaces the old NCBI “legacy” BLAST package. The `Bio.Blast.Applications` module has wrappers for these “new” tools like `blastn`, `blastp`, `blastx`, `tblastn`, `tblastx` (which all used to be handled by `blastall`), `psiblast` (replacing `blastpgp`) and `rpsblast` and `rpstblastn` (which replace the old `rpsblast`).

This section will show briefly how to use these tools from within Python. If you have already read or tried the alignment tool examples in Section 6.4 this should all seem quite straightforward. First, we construct a command line string (as you would type in at the command line prompt if running standalone BLAST by hand). Then we can execute this command from within Python, typically using the `subprocess` module.

For example, taking a FASTA file of gene nucleotide sequences, you might want to run a BLASTX (translation) search against the non-redundant (NR) protein database. Assuming you (or your systems administrator) has downloaded and installed the NR database, you might run:

```
blastx -query opuntia.fasta -db nr -out opuntia.xml -evalue 0.001 -outfmt 5
```

This should run BLASTX against the NR database, using an expectation cut-off value of 0.001 and produce XML output to the specified file (which we can then parse). On my computer this takes about six minutes - a good reason to save the output to a file so you can repeat any analysis as needed.

From within Biopython we can use the NCBI BLASTX wrapper from the `Bio.Blast.Applications` module to build the command line string:

```

>>> from Bio.Blast.Applications import NcbiblastxCommandline
>>> help(NcbiblastxCommandline)
...
>>> cline = NcbiblastxCommandline(query="opuntia.fasta", db="nr", evalue=0.001, outfmt=5,
... out="opuntia.xml")
>>> cline
NcbiblastxCommandline(cmd='blastx', query='opuntia.fasta', db='nr', out='opuntia.xml',
evalue=0.001, outfmt=5)
>>> print cline
blastx -query opuntia.fasta -db nr -out opuntia.xml -evalue 0.001 -outfmt 5

```

In this example there shouldn't be any output from BLASTX to the terminal (stdout or stderr), so we can call the tool like this:

```

>>> import sys
>>> import subprocess
>>> return_code = subprocess.call(str(cline), shell=(sys.platform!="win32"))
...
>>> print return_code
0

```

Here the ... means wait for the command to finish. We then check the return code, remember that zero usually means no errors. You could also check the output file `opuntia.xml` has been created.

As you may recall from earlier examples in the tutorial, the `opuntia.fasta` contains seven sequences, so the BLAST XML output should contain multiple results. Therefore use `Bio.Blast.NCBIXML.parse()` to parse it as described below in Section 7.3.

7.2.4 WU-BLAST and AB-BLAST

You may also come across [Washington University BLAST](#) (WU-BLAST), and its successor, [Advanced Bio-computing BLAST](#) (AB-BLAST, released in 2009, not free/open source). These packages include the command line tools `wu-blastall` and `ab-blastall`.

Biopython does not currently provide wrappers for calling these tools, but should be able to parse any NCBI compatible output from them.

7.3 Parsing BLAST output

As mentioned above, BLAST can generate output in various formats, such as XML, HTML, and plain text. Originally, Biopython had parsers for BLAST plain text and HTML output, as these were the only output formats offered at the time. Unfortunately, the BLAST output in these formats kept changing, each time breaking the Biopython parsers. Our HTML BLAST parser has been removed, but the plain text BLAST parser is still available (see Section 7.5). Use it at your own risk, it may or may not work, depending on which BLAST version you're using.

As keeping up with changes in BLAST became a hopeless endeavor, especially with users running different BLAST versions, we now recommend to parse the output in XML format, which can be generated by recent versions of BLAST. Not only is the XML output more stable than the plain text and HTML output, it is also much easier to parse automatically, making Biopython a whole lot more stable.

You can get BLAST output in XML format in various ways. For the parser, it doesn't matter how the output was generated, as long as it is in the XML format.

- You can use Biopython to run BLAST over the internet, as described in section 7.1.
- You can use Biopython to run BLAST locally, as described in section 7.2.

- You can do the BLAST search yourself on the NCBI site through your web browser, and then save the results. You need to choose XML as the format in which to receive the results, and save the final BLAST page you get (you know, the one with all of the interesting results!) to a file.
- You can also run BLAST locally without using Biopython, and save the output in a file. Again, you need to choose XML as the format in which to receive the results.

The important point is that you do not have to use Biopython scripts to fetch the data in order to be able to parse it. Doing things in one of these ways, you then need to get a handle to the results. In Python, a handle is just a nice general way of describing input to any info source so that the info can be retrieved using `read()` and `readline()` functions (see Section `sec:appendix-handles`).

If you followed the code above for interacting with BLAST through a script, then you already have `result_handle`, the handle to the BLAST results. For example, using a GI number to do an online search:

```
>>> from Bio.Blast import NCBIWWW
>>> result_handle = NCBIWWW.qblast("blastn", "nr", "8332116")
```

If instead you ran BLAST some other way, and have the BLAST output (in XML format) in the file `my_blast.xml`, all you need to do is to open the file for reading:

```
>>> result_handle = open("my_blast.xml")
```

Now that we've got a handle, we are ready to parse the output. The code to parse it is really quite small. If you expect a single BLAST result (i.e. you used a single query):

```
>>> from Bio.Blast import NCBIXML
>>> blast_record = NCBIXML.read(result_handle)
```

or, if you have lots of results (i.e. multiple query sequences):

```
>>> from Bio.Blast import NCBIXML
>>> blast_records = NCBIXML.parse(result_handle)
```

Just like `Bio.SeqIO` and `Bio.AlignIO` (see Chapters 5 and 6), we have a pair of input functions, `read` and `parse`, where `read` is for when you have exactly one object, and `parse` is an iterator for when you can have lots of objects – but instead of getting `SeqRecord` or `MultipleSeqAlignment` objects, we get BLAST record objects.

To be able to handle the situation where the BLAST file may be huge, containing thousands of results, `NCBIXML.parse()` returns an iterator. In plain English, an iterator allows you to step through the BLAST output, retrieving BLAST records one by one for each BLAST search result:

```
>>> from Bio.Blast import NCBIXML
>>> blast_records = NCBIXML.parse(result_handle)
>>> blast_record = blast_records.next()
# ... do something with blast_record
>>> blast_record = blast_records.next()
# ... do something with blast_record
>>> blast_record = blast_records.next()
# ... do something with blast_record
>>> blast_record = blast_records.next()
Traceback (most recent call last):
  File "<stdin>", line 1, in <module>
StopIteration
# No further records
```

Or, you can use a for-loop:

```
>>> for blast_record in blast_records:
...     # Do something with blast_record
```

Note though that you can step through the BLAST records only once. Usually, from each BLAST record you would save the information that you are interested in. If you want to save all returned BLAST records, you can convert the iterator into a list:

```
>>> blast_records = list(blast_records)
```

Now you can access each BLAST record in the list with an index as usual. If your BLAST file is huge though, you may run into memory problems trying to save them all in a list.

Usually, you'll be running one BLAST search at a time. Then, all you need to do is to pick up the first (and only) BLAST record in `blast_records`:

```
>>> from Bio.Blast import NCBIXML
>>> blast_records = NCBIXML.parse(result_handle)
>>> blast_record = blast_records.next()
```

or more elegantly:

```
>>> from Bio.Blast import NCBIXML
>>> blast_record = NCBIXML.read(result_handle)
```

I guess by now you're wondering what is in a BLAST record.

7.4 The BLAST record class

A BLAST Record contains everything you might ever want to extract from the BLAST output. Right now we'll just show an example of how to get some info out of the BLAST report, but if you want something in particular that is not described here, look at the info on the record class in detail, and take a gander into the code or automatically generated documentation – the docstrings have lots of good info about what is stored in each piece of information.

To continue with our example, let's just print out some summary info about all hits in our blast report greater than a particular threshold. The following code does this:

```
>>> E_VALUE_THRESH = 0.04

>>> for alignment in blast_record.alignments:
...     for hsp in alignment.hsps:
...         if hsp.expect < E_VALUE_THRESH:
...             print '****Alignment****'
...             print 'sequence:', alignment.title
...             print 'length:', alignment.length
...             print 'e value:', hsp.expect
...             print hsp.query[0:75] + '...'
...             print hsp.match[0:75] + '...'
...             print hsp.sbjct[0:75] + '...'
```

This will print out summary reports like the following:

```
****Alignment****
sequence: >gb|AF283004.1|AF283004 Arabidopsis thaliana cold acclimation protein WCOR413-like protein
alpha form mRNA, complete cds
```

```

length: 783
e value: 0.034
tacttggtgatattggatcgaacaaactggagaaccaacatgctcacgtcacttttagtcccttacatattctc...
||||||| | ||||||||| | |||| | | ||||||| ||||| | | ||||||| ||| ||...
tacttggtggtggtgatcgaaccaattggaagacgaatatgctcacatcacttctcattccttacatcttctc...

```

Basically, you can do anything you want to with the info in the BLAST report once you have parsed it. This will, of course, depend on what you want to use it for, but hopefully this helps you get started on doing what you need to do!

An important consideration for extracting information from a BLAST report is the type of objects that the information is stored in. In Biopython, the parsers return `Record` objects, either `Blast` or `PSIBlast` depending on what you are parsing. These objects are defined in `Bio.Blast.Record` and are quite complete.

Here are my attempts at UML class diagrams for the `Blast` and `PSIBlast` record classes. If you are good at UML and see mistakes/improvements that can be made, please let me know. The `Blast` class diagram is shown in Figure 7.1.

The `PSIBlast` record object is similar, but has support for the rounds that are used in the iteration steps of `PSIBlast`. The class diagram for `PSIBlast` is shown in Figure 7.2.

7.5 Deprecated BLAST parsers

Older versions of Biopython had parsers for BLAST output in plain text or HTML format. Over the years, we discovered that it is very hard to maintain these parsers in working order. Basically, any small change to the BLAST output in newly released BLAST versions tends to cause the plain text and HTML parsers to break. We therefore recommend parsing BLAST output in XML format, as described in section 7.3.

Depending on which BLAST versions or programs you're using, our plain text BLAST parser may or may not work. Use it at your own risk!

7.5.1 Parsing plain-text BLAST output

The plain text BLAST parser is located in `Bio.Blast.NCBISTandalone`.

As with the XML parser, we need to have a handle object that we can pass to the parser. The handle must implement the `readline()` method and do this properly. The common ways to get such a handle are to either use the provided `blastall` or `blastpgp` functions to run the local blast, or to run a local blast via the command line, and then do something like the following:

```
>>> result_handle = open("my_file_of_blast_output.txt")
```

Well, now that we've got a handle (which we'll call `result_handle`), we are ready to parse it. This can be done with the following code:

```
>>> from Bio.Blast import NCBISTandalone
>>> blast_parser = NCBISTandalone.BlastParser()
>>> blast_record = blast_parser.parse(result_handle)
```

This will parse the BLAST report into a `Blast Record` class (either a `Blast` or a `PSIBlast` record, depending on what you are parsing) so that you can extract the information from it. In our case, let's just use `print` out a quick summary of all of the alignments greater than some threshold value.

```
>>> E_VALUE_THRESH = 0.04
>>> for alignment in blast_record.alignments:
...     for hsp in alignment.hsps:
...         if hsp.expect < E_VALUE_THRESH:
```

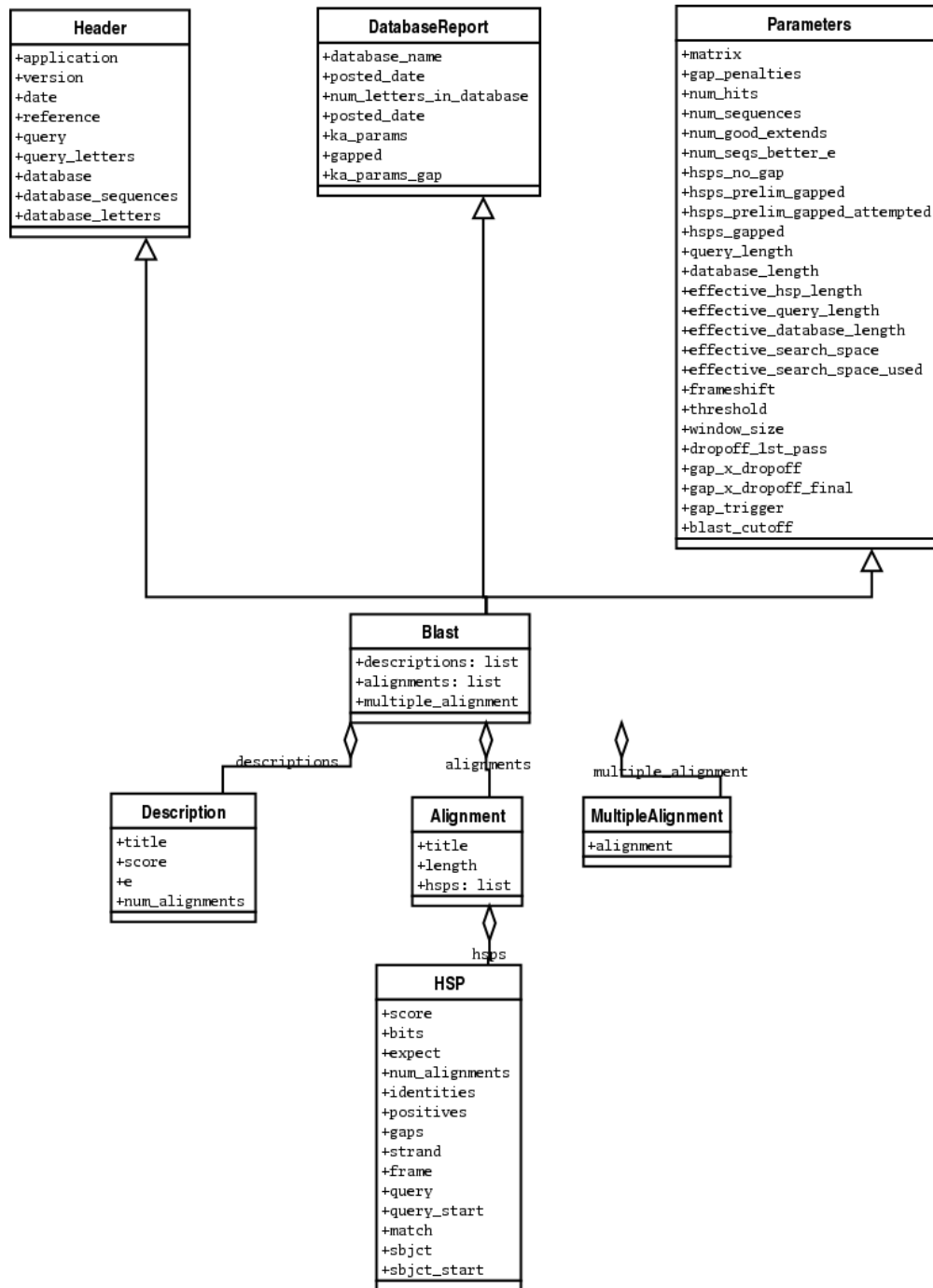

Figure 7.1: Class diagram for the Blast Record class representing all of the info in a BLAST report

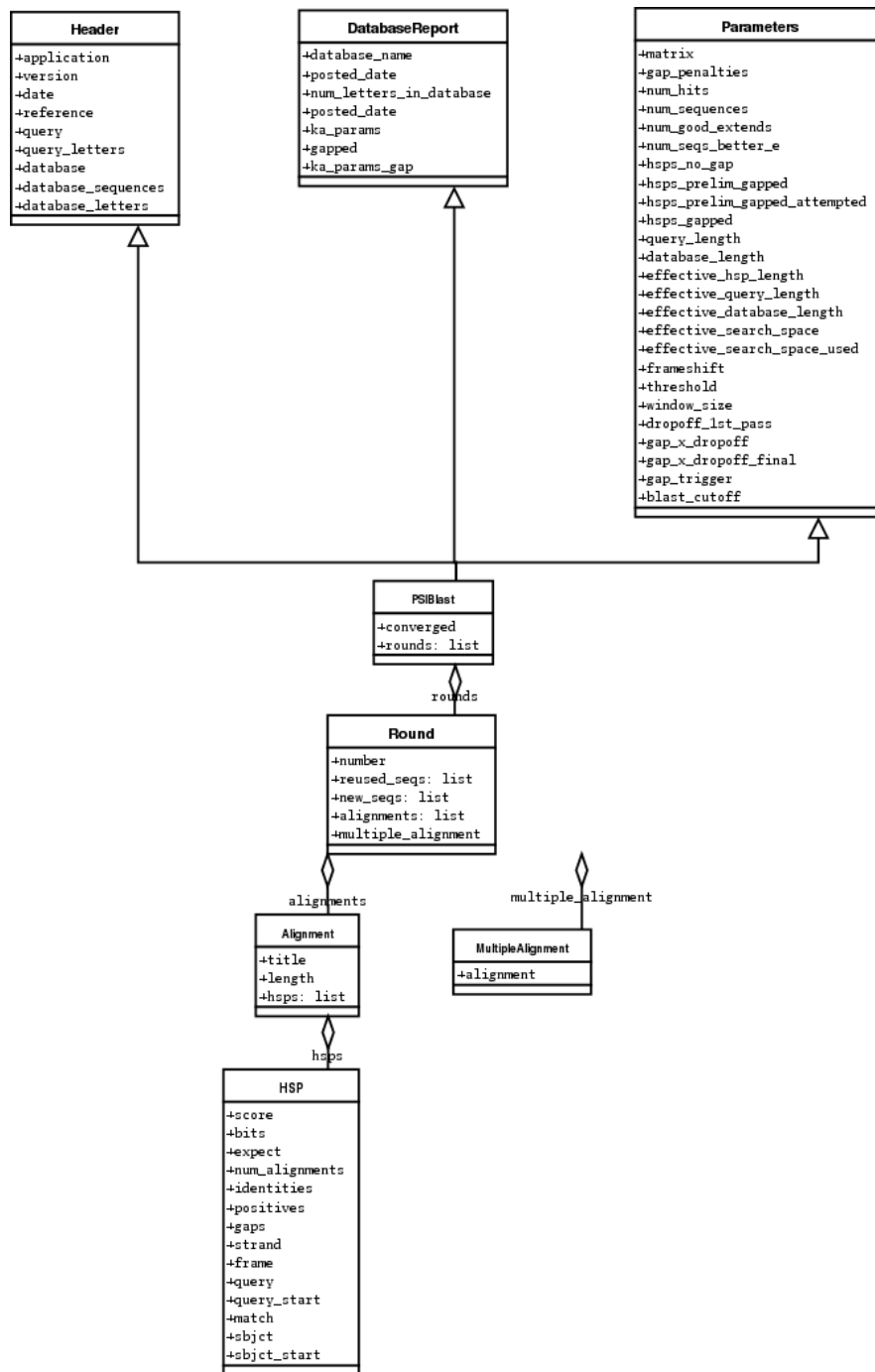

Figure 7.2: Class diagram for the PSIBlast Record class.

```

...         print '****Alignment****'
...         print 'sequence:', alignment.title
...         print 'length:', alignment.length
...         print 'e value:', hsp.expect
...         print hsp.query[0:75] + '...'
...         print hsp.match[0:75] + '...'
...         print hsp.sbjct[0:75] + '...'

```

If you also read the section [7.3](#) on parsing BLAST XML output, you'll notice that the above code is identical to what is found in that section. Once you parse something into a record class you can deal with it independent of the format of the original BLAST info you were parsing. Pretty snazzy!

Sure, parsing one record is great, but I've got a BLAST file with tons of records – how can I parse them all? Well, fear not, the answer lies in the very next section.

7.5.2 Parsing a plain-text BLAST file full of BLAST runs

We can do this using the blast iterator. To set up an iterator, we first set up a parser, to parse our blast reports in Blast Record objects:

```

>>> from Bio.Blast import NCBIStandalone
>>> blast_parser = NCBIStandalone.BlastParser()

```

Then we will assume we have a handle to a bunch of blast records, which we'll call `result_handle`. Getting a handle is described in full detail above in the blast parsing sections.

Now that we've got a parser and a handle, we are ready to set up the iterator with the following command:

```

>>> blast_iterator = NCBIStandalone.Iterator(result_handle, blast_parser)

```

The second option, the parser, is optional. If we don't supply a parser, then the iterator will just return the raw BLAST reports one at a time.

Now that we've got an iterator, we start retrieving blast records (generated by our parser) using `next()`:

```

>>> blast_record = blast_iterator.next()

```

Each call to `next` will return a new record that we can deal with. Now we can iterate through this records and generate our old favorite, a nice little blast report:

```

>>> for blast_record in blast_iterator:
...     E_VALUE_THRESH = 0.04
...     for alignment in blast_record.alignments:
...         for hsp in alignment.hsps:
...             if hsp.expect < E_VALUE_THRESH:
...                 print '****Alignment****'
...                 print 'sequence:', alignment.title
...                 print 'length:', alignment.length
...                 print 'e value:', hsp.expect
...                 if len(hsp.query) > 75:
...                     dots = '...'
...                 else:
...                     dots = ''
...                 print hsp.query[0:75] + dots
...                 print hsp.match[0:75] + dots
...                 print hsp.sbjct[0:75] + dots

```

The iterator allows you to deal with huge blast records without any memory problems, since things are read in one at a time. I have parsed tremendously huge files without any problems using this.

7.5.3 Finding a bad record somewhere in a huge plain-text BLAST file

One really ugly problem that happens to me is that I'll be parsing a huge blast file for a while, and the parser will bomb out with a `ValueError`. This is a serious problem, since you can't tell if the `ValueError` is due to a parser problem, or a problem with the BLAST. To make it even worse, you have no idea where the parse failed, so you can't just ignore the error, since this could be ignoring an important data point.

We used to have to make a little script to get around this problem, but the `Bio.Blast` module now includes a `BlastErrorParser` which really helps make this easier. The `BlastErrorParser` works very similar to the regular `BlastParser`, but it adds an extra layer of work by catching `ValueErrors` that are generated by the parser, and attempting to diagnose the errors.

Let's take a look at using this parser – first we define the file we are going to parse and the file to write the problem reports to:

```
>>> import os
>>> blast_file = os.path.join(os.getcwd(), "blast_out", "big_blast.out")
>>> error_file = os.path.join(os.getcwd(), "blast_out", "big_blast.problems")
```

Now we want to get a `BlastErrorParser`:

```
>>> from Bio.Blast import NCBIStandalone
>>> error_handle = open(error_file, "w")
>>> blast_error_parser = NCBIStandalone.BlastErrorParser(error_handle)
```

Notice that the parser take an optional argument of a handle. If a handle is passed, then the parser will write any blast records which generate a `ValueError` to this handle. Otherwise, these records will not be recorded.

Now we can use the `BlastErrorParser` just like a regular blast parser. Specifically, we might want to make an iterator that goes through our blast records one at a time and parses them with the error parser:

```
>>> result_handle = open(blast_file)
>>> iterator = NCBIStandalone.Iterator(result_handle, blast_error_parser)
```

We can read these records one a time, but now we can catch and deal with errors that are due to problems with Blast (and not with the parser itself):

```
>>> try:
...     next_record = iterator.next()
... except NCBIStandalone.LowQualityBlastError, info:
...     print "LowQualityBlastError detected in id %s" % info[1]
```

The `.next()` method is normally called indirectly via a `for`-loop. Right now the `BlastErrorParser` can generate the following errors:

- `ValueError` – This is the same error generated by the regular `BlastParser`, and is due to the parser not being able to parse a specific file. This is normally either due to a bug in the parser, or some kind of discrepancy between the version of BLAST you are using and the versions the parser is able to handle.
- `LowQualityBlastError` – When BLASTing a sequence that is of really bad quality (for example, a short sequence that is basically a stretch of one nucleotide), it seems that Blast ends up masking out the entire sequence and ending up with nothing to parse. In this case it will produce a truncated report that causes the parser to generate a `ValueError`. `LowQualityBlastError` is reported in these cases. This error returns an `info` item with the following information:

- `item[0]` – The error message

- `item[1]` – The id of the input record that caused the error. This is really useful if you want to record all of the records that are causing problems.

As mentioned, with each error generated, the `BlastErrorParser` will write the offending record to the specified `error_handle`. You can then go ahead and look and these and deal with them as you see fit. Either you will be able to debug the parser with a single blast report, or will find out problems in your blast runs. Either way, it will definitely be a useful experience!

Hopefully the `BlastErrorParser` will make it much easier to debug and deal with large Blast files.

7.6 Dealing with PSI-BLAST

You can run the standalone version of PSI-BLAST (the legacy NCBI command line tool `blastpgp`, or its replacement `psiblast`) using the wrappers in `Bio.Blast.Applications` module.

At the time of writing, the NCBI do not appear to support tools running a PSI-BLAST search via the internet.

Note that the `Bio.Blast.NCBIXML` parser can read the XML output from current versions of PSI-BLAST, but information like which sequences in each iteration is new or reused isn't present in the XML file. If you care about this information you may have more joy with the plain text output and the `PSIBlastParser` in `Bio.Blast.NCBISTandalone`.

7.7 Dealing with RPS-BLAST

You can run the standalone version of RPS-BLAST (either the legacy NCBI command line tool `rpsblast`, or its replacement with the same name) using the wrappers in `Bio.Blast.Applications` module.

At the time of writing, the NCBI do not appear to support tools running an RPS-BLAST search via the internet.

You can use the `Bio.Blast.NCBIXML` parser to read the XML output from current versions of RPS-BLAST.

Chapter 8

Accessing NCBI's Entrez databases

Entrez (<http://www.ncbi.nlm.nih.gov/Entrez>) is a data retrieval system that provides users access to NCBI's databases such as PubMed, GenBank, GEO, and many others. You can access Entrez from a web browser to manually enter queries, or you can use Biopython's `Bio.Entrez` module for programmatic access to Entrez. The latter allows you for example to search PubMed or download GenBank records from within a Python script.

The `Bio.Entrez` module makes use of the Entrez Programming Utilities (also known as EUtils), consisting of eight tools that are described in detail on NCBI's page at <http://www.ncbi.nlm.nih.gov/entrez/utils/>. Each of these tools corresponds to one Python function in the `Bio.Entrez` module, as described in the sections below. This module makes sure that the correct URL is used for the queries, and that not more than one request is made every three seconds, as required by NCBI.

The output returned by the Entrez Programming Utilities is typically in XML format. To parse such output, you have several options:

1. Use `Bio.Entrez`'s parser to parse the XML output into a Python object;
2. Use the DOM (Document Object Model) parser in Python's standard library;
3. Use the SAX (Simple API for XML) parser in Python's standard library;
4. Read the XML output as raw text, and parse it by string searching and manipulation.

For the DOM and SAX parsers, see the Python documentation. The parser in `Bio.Entrez` is discussed below.

NCBI uses DTD (Document Type Definition) files to describe the structure of the information contained in XML files. Most of the DTD files used by NCBI are included in the Biopython distribution. The `Bio.Entrez` parser makes use of the DTD files when parsing an XML file returned by NCBI Entrez.

Occasionally, you may find that the DTD file associated with a specific XML file is missing in the Biopython distribution. In particular, this may happen when NCBI updates its DTD files. If this happens, `Entrez.read` will give an error message showing which DTD file is missing. You can download the DTD file from NCBI; most can be found at <http://www.ncbi.nlm.nih.gov/dtd/> or <http://eutils.ncbi.nlm.nih.gov/entrez/query/DTD/>. After downloading, the DTD file should be stored in the directory `...site-packages/Bio/Entrez/DTDs`, containing the other DTD files. Alternatively, if you installed Biopython from source, you can add the DTD file to the source code's `Bio/Entrez/DTDs` directory, and reinstall Biopython. This will install the new DTD file in the correct location together with the other DTD files.

The Entrez Programming Utilities can also generate output in other formats, such as the Fasta or GenBank file formats for sequence databases, or the MedLine format for the literature database, discussed in Section 8.11.

8.1 Entrez Guidelines

Before using Biopython to access the NCBI's online resources (via `Bio.Entrez` or some of the other modules), please read the [NCBI's Entrez User Requirements](#). If the NCBI finds you are abusing their systems, they can and will ban your access!

To paraphrase:

- For any series of more than 100 requests, do this at weekends or outside USA peak times. This is up to you to obey.
- Use the <http://eutils.ncbi.nlm.nih.gov> address, not the standard NCBI Web address. Biopython uses this web address.
- Make no more than three requests every seconds (relaxed from at most one request every three seconds in early 2009). This is automatically enforced by Biopython.
- Use the optional email parameter so the NCBI can contact you if there is a problem. You can either explicitly set this as a parameter with each call to Entrez (e.g. include `email="A.N.Other@example.com"` in the argument list), or as of Biopython 1.48, you can set a global email address:

```
>>> from Bio import Entrez
>>> Entrez.email = "A.N.Other@example.com"
```

`Bio.Entrez` will then use this email address with each call to Entrez. The `example.com` address is a reserved domain name specifically for documentation (RFC 2606). Please DO NOT use a random email – it's better not to give an email at all. The email parameter will be mandatory from June 1, 2010. In case of excessive usage, NCBI will attempt to contact a user at the e-mail address provided prior to blocking access to the E-utilities.

- If you are using Biopython within some larger software suite, use the tool parameter to specify this. You can either explicitly set the tool name as a parameter with each call to Entrez (e.g. include `tool="MyLocalScript"` in the argument list), or as of Biopython 1.54, you can set a global tool name:

```
>>> from Bio import Entrez
>>> Entrez.tool = "MyLocalScript"
```

The tool parameter will default to Biopython.

- For large queries, the NCBI also recommend using their session history feature (the `WebEnv` session cookie string, see [Section 8.14](#)). This is only slightly more complicated.

In conclusion, be sensible with your usage levels. If you plan to download lots of data, consider other options. For example, if you want easy access to all the human genes, consider fetching each chromosome by FTP as a GenBank file, and importing these into your own BioSQL database (see [Section 14.5](#)).

8.2 EInfo: Obtaining information about the Entrez databases

EInfo provides field index term counts, last update, and available links for each of NCBI's databases. In addition, you can use EInfo to obtain a list of all database names accessible through the Entrez utilities:

```
>>> from Bio import Entrez
>>> Entrez.email = "A.N.Other@example.com"      # Always tell NCBI who you are
>>> handle = Entrez.einfo()
>>> result = handle.read()
```

The variable `result` now contains a list of databases in XML format:

```
>>> print result
<?xml version="1.0"?>
<!DOCTYPE eInfoResult PUBLIC "-//NLM//DTD eInfoResult, 11 May 2002//EN"
"http://www.ncbi.nlm.nih.gov/entrez/query/DTD/eInfo_020511.dtd">
<eInfoResult>
<DbList>
  <DbName>pubmed</DbName>
  <DbName>protein</DbName>
  <DbName>nucleotide</DbName>
  <DbName>nuccore</DbName>
  <DbName>nucgss</DbName>
  <DbName>nucest</DbName>
  <DbName>structure</DbName>
  <DbName>genome</DbName>
  <DbName>books</DbName>
  <DbName>cancerchromosomes</DbName>
  <DbName>cdd</DbName>
  <DbName>gap</DbName>
  <DbName>domains</DbName>
  <DbName>gene</DbName>
  <DbName>genomeprj</DbName>
  <DbName>gensat</DbName>
  <DbName>geo</DbName>
  <DbName>gds</DbName>
  <DbName>homologene</DbName>
  <DbName>journals</DbName>
  <DbName>mesh</DbName>
  <DbName>ncbisearch</DbName>
  <DbName>nlmcatalog</DbName>
  <DbName>omia</DbName>
  <DbName>omim</DbName>
  <DbName>pmc</DbName>
  <DbName>popset</DbName>
  <DbName>probe</DbName>
  <DbName>proteinclusters</DbName>
  <DbName>pcassay</DbName>
  <DbName>pccompound</DbName>
  <DbName>pctest</DbName>
  <DbName>snpc</DbName>
  <DbName>taxonomy</DbName>
  <DbName>toolkit</DbName>
  <DbName>unigene</DbName>
  <DbName>unists</DbName>
</DbList>
</eInfoResult>
```

Since this is a fairly simple XML file, we could extract the information it contains simply by string searching. Using `Bio.Entrez`'s parser instead, we can directly parse this XML file into a Python object:

```
>>> from Bio import Entrez
>>> handle = Entrez.einfo()
```

```
>>> record = Entrez.read(handle)
```

Now `record` is a dictionary with exactly one key:

```
>>> record.keys()
[u'DbList']
```

The values stored in this key is the list of database names shown in the XML above:

```
>>> record["DbList"]
['pubmed', 'protein', 'nucleotide', 'nucore', 'nucgss', 'nucest',
 'structure', 'genome', 'books', 'cancerchromosomes', 'cdd', 'gap',
 'domains', 'gene', 'genomeprj', 'gensat', 'geo', 'gds', 'homologene',
 'journals', 'mesh', 'ncbisearch', 'nlmcatalog', 'omia', 'omim', 'pmc',
 'popset', 'probe', 'proteinclusters', 'pcassay', 'pccompound',
 'pcsubstance', 'snp', 'taxonomy', 'toolkit', 'unigene', 'unists']
```

For each of these databases, we can use `EInfo` again to obtain more information:

```
>>> handle = Entrez.einfo(db="pubmed")
>>> record = Entrez.read(handle)
>>> record["DbInfo"]["Description"]
'PubMed bibliographic record'
>>> record["DbInfo"]["Count"]
'17989604'
>>> record["DbInfo"]["LastUpdate"]
'2008/05/24 06:45'
```

Try `record["DbInfo"].keys()` for other information stored in this record. One of the most useful is a list of possible search fields for use with `ESearch`:

```
>>> for field in record["DbInfo"]["FieldList"]:
...     print "%(Name)s, %(FullName)s, %(Description)s" % field
ALL, All Fields, All terms from all searchable fields
UID, UID, Unique number assigned to publication
FILT, Filter, Limits the records
TITL, Title, Words in title of publication
WORD, Text Word, Free text associated with publication
MESH, MeSH Terms, Medical Subject Headings assigned to publication
MAJR, MeSH Major Topic, MeSH terms of major importance to publication
AUTH, Author, Author(s) of publication
JOUR, Journal, Journal abbreviation of publication
AFFL, Affiliation, Author's institutional affiliation and address
...
```

That's a long list, but indirectly this tells you that for the PubMed database, you can do things like `Jones[AUTH]` to search the author field, or `Sanger[AFFL]` to restrict to authors at the Sanger Centre. This can be very handy - especially if you are not so familiar with a particular database.

8.3 ESearch: Searching the Entrez databases

To search any of these databases, we use `Bio.Entrez.esearch()`. For example, let's search in PubMed for publications related to Biopython:

```
>>> from Bio import Entrez
>>> Entrez.email = "A.N.Other@example.com"      # Always tell NCBI who you are
>>> handle = Entrez.esearch(db="pubmed", term="biopython")
>>> record = Entrez.read(handle)
>>> record["IdList"]
['19304878', '18606172', '16403221', '16377612', '14871861', '14630660', '12230038']
```

In this output, you see seven PubMed IDs (including 19304878 which is the PMID for the Biopython application note), which can be retrieved by EFetch (see section 8.6).

You can also use ESearch to search GenBank. Here we'll do a quick search for the *matK* gene in *Cypripedioideae* orchids (see Section 8.2 about EInfo for one way to find out which fields you can search in each Entrez database):

```
>>> handle = Entrez.esearch(db="nucleotide", term="Cypripedioideae[Orgn] AND matK[Gene]")
>>> record = Entrez.read(handle)
>>> record["Count"]
'25'
>>> record["IdList"]
['126789333', '37222967', '37222966', '37222965', ..., '61585492']
```

Each of the IDs (126789333, 37222967, 37222966, ...) is a GenBank identifier. See section 8.6 for information on how to actually download these GenBank records.

Note that instead of a species name like *Cypripedioideae*[Orgn], you can restrict the search using an NCBI taxon identifier, here this would be *txid158330*[Orgn]. This isn't currently documented on the ESearch help page - the NCBI explained this in reply to an email query. You can often deduce the search term formatting by playing with the Entrez web interface. For example, including *complete*[prop] in a genome search restricts to just completed genomes.

As a final example, let's get a list of computational journal titles:

```
>>> handle = Entrez.esearch(db="journals", term="computational")
>>> record = Entrez.read(handle)
>>> record["Count"]
'16'
>>> record["IdList"]
['30367', '33843', '33823', '32989', '33190', '33009', '31986',
 '34502', '8799', '22857', '32675', '20258', '33859', '32534',
 '32357', '32249']
```

Again, we could use EFetch to obtain more information for each of these journal IDs.

ESearch has many useful options — see the [ESearch help page](#) for more information.

8.4 EPost: Uploading a list of identifiers

EPost uploads a list of UIs for use in subsequent search strategies; see the [EPost help page](#) for more information. It is available from Biopython through the `Bio.Entrez.epost()` function.

To give an example of when this is useful, suppose you have a long list of IDs you want to download using EFetch (maybe sequences, maybe citations – anything). When you make a request with EFetch your list of IDs, the database etc, are all turned into a long URL sent to the server. If your list of IDs is long, this URL gets long, and long URLs can break (e.g. some proxies don't cope well).

Instead, you can break this up into two steps, first uploading the list of IDs using EPost (this uses an “HTML post” internally, rather than an “HTML get”, getting round the long URL problem). With the history support, you can then refer to this long list of IDs, and download the associated data with EFetch.

Let's look at a simple example to see how EPost works – uploading some PubMed identifiers:

```

>>> from Bio import Entrez
>>> Entrez.email = "A.N.Other@example.com"      # Always tell NCBI who you are
>>> id_list = ["19304878", "18606172", "16403221", "16377612", "14871861", "14630660"]
>>> print Entrez.epost("pubmed", id=",".join(id_list)).read()
<?xml version="1.0"?>
<!DOCTYPE ePostResult PUBLIC "-//NLM//DTD ePostResult, 11 May 2002//EN"
  "http://www.ncbi.nlm.nih.gov/entrez/query/DTD/ePost_020511.dtd">
<ePostResult>
<QueryKey>1</QueryKey>
<WebEnv>NCID_01_206841095_130.14.22.101_9001_1242061629</WebEnv>
</ePostResult>

```

The returned XML includes two important strings, `QueryKey` and `WebEnv` which together define your history session. You would extract these values for use with another Entrez call such as `EFetch`:

```

from Bio import Entrez
Entrez.email = "A.N.Other@example.com"      # Always tell NCBI who you are
id_list = ["19304878", "18606172", "16403221", "16377612", "14871861", "14630660"]
search_results = Entrez.read(Entrez.epost("pubmed", id=",".join(id_list)))
webenv = search_results["WebEnv"]
query_key = search_results["QueryKey"]

```

Section 8.14 shows how to use the history feature.

8.5 ESummary: Retrieving summaries from primary IDs

`ESummary` retrieves document summaries from a list of primary IDs (see the [ESummary help page](#) for more information). In Biopython, `ESummary` is available as `Bio.Entrez.esummary()`. Using the search result above, we can for example find out more about the journal with ID 30367:

```

>>> from Bio import Entrez
>>> Entrez.email = "A.N.Other@example.com"      # Always tell NCBI who you are
>>> handle = Entrez.esummary(db="journals", id="30367")
>>> record = Entrez.read(handle)
>>> record[0]["Id"]
'30367'
>>> record[0]["Title"]
'Computational biology and chemistry'
>>> record[0]["Publisher"]
'Pergamon,'

```

8.6 EFetch: Downloading full records from Entrez

`EFetch` is what you use when you want to retrieve a full record from Entrez. This covers several possible databases, as described on the main [EFetch Help page](#).

For most of their databases, the NCBI support several different file formats. Requesting a specific file format from Entrez using `Bio.Entrez.efetch()` requires specifying the `rettype` and/or `retmode` optional arguments. The different combinations are described for each database type on the pages linked to on [NCBI efetch webpage](#) (e.g. [literature](#), [sequences](#) and [taxonomy](#)).

One common usage is downloading sequences in the FASTA or GenBank/GenPept plain text formats (which can then be parsed with `Bio.SeqIO`, see Sections 5.2.1 and 8.6). From the *Cypripedioideae* example above, we can download GenBank record 186972394 using `Bio.Entrez.efetch`:

```

>>> from Bio import Entrez
>>> Entrez.email = "A.N.Other@example.com"      # Always tell NCBI who you are
>>> handle = Entrez.efetch(db="nucleotide", id="186972394", rettype="gb")
>>> print handle.read()
LOCUS      EU490707                1302 bp    DNA     linear   PLN 05-MAY-2008
DEFINITION Selenipedium aequinoctiale maturase K (matK) gene, partial cds;
            chloroplast.
ACCESSION  EU490707
VERSION    EU490707.1  GI:186972394
KEYWORDS   .
SOURCE     chloroplast Selenipedium aequinoctiale
  ORGANISM Selenipedium aequinoctiale
            Eukaryota; Viridiplantae; Streptophyta; Embryophyta; Tracheophyta;
            Spermatophyta; Magnoliophyta; Liliopsida; Asparagales; Orchidaceae;
            Cypridioideae; Selenipedium.
REFERENCE  1 (bases 1 to 1302)
  AUTHORS  Neubig,K.M., Whitten,W.M., Carlsward,B.S., Blanco,M.A.,
            Endara,C.L., Williams,N.H. and Moore,M.J.
  TITLE    Phylogenetic utility of ycf1 in orchids
  JOURNAL  Unpublished
REFERENCE  2 (bases 1 to 1302)
  AUTHORS  Neubig,K.M., Whitten,W.M., Carlsward,B.S., Blanco,M.A.,
            Endara,C.L., Williams,N.H. and Moore,M.J.
  TITLE    Direct Submission
  JOURNAL  Submitted (14-FEB-2008) Department of Botany, University of
            Florida, 220 Bartram Hall, Gainesville, FL 32611-8526, USA
FEATURES   Location/Qualifiers
  source   1..1302
            /organism="Selenipedium aequinoctiale"
            /organelle="plastid:chloroplast"
            /mol_type="genomic DNA"
            /specimen_voucher="FLAS:Blanco 2475"
            /db_xref="taxon:256374"
  gene     <1..>1302
            /gene="matK"
  CDS      <1..>1302
            /gene="matK"
            /codon_start=1
            /transl_table=11
            /product="maturase K"
            /protein_id="ACC99456.1"
            /db_xref="GI:186972395"
            /translation="IFYEPVEIFGYDNKSSLVLVKRLITRMYQQNFLISSVNDNQKG
            FWGHKHFSSHFSSQMVSEGFVILEIPFSSQLVSSLEKKIPKYQNLRSIHSIFPFL
            EDKFLHNLNVSDLLIPHPHLEILVQILQCRIKDVPSLHLLRLLFHEYHNLNLSLITSK
            KFIYAFSKRKKRFLWLLYNSVYVECEYLFQFLRKQSSYLSTSSGVFLERTHLYVKIE
            HLLVCCNSFQRILCFLKDPFMHYVRYQGKAILASKGTLILMKKWKFHLLVNFVQSYFH
            FWSQPYRIHIKQLSNYSFSLGYFSSVLENHLVVRNQMLENSFIINLLTKKFDTIAPV
            ISLIGLSKAQFCTVLGHPISKPIWTFSDSDILDRFCRICRNLCRYHSGSSKKQVLY
            RIKYILRLSCARTLARKHKSTVTRTFMRRLGSGLLEEFFMEEE"
ORIGIN

```

```

1 attttttacg aacctgtgga aatTTTTggt tatgacaata aatctagttt agtacttgtg
61 aaacgtttaa ttactcgaat gtatcaacag aatTTTTtga tttcttcggt taatgattct
121 aaccaaaaag gattttgggg gcacaagcat ttttttctt ctcatttttc ttctcaaatg
181 gtatcagaag gttttggagt cattctggaa attccattct cgtcgcaatt agtatcttct
241 cttgaagaaa aaaaaatacc aaaatatcag aatttacgat ctattcattc aatatttccc
301 tttttagaag acaaattttt acatttgaat tatgtgtcag atctactaat accccatccc
361 atccatctgg aaatcttggg tcaaatcctt caatgccgga tcaaggatgt tccttctttg
421 catttattgc gattgctttt ccacgaatat cataatttga atagtctcat tacttcaaag
481 aaattcattt acgccttttc aaaaagaaag aaaagattcc tttggttact atataattct
541 tatgtatatg aatgcgaata tctattccag tttcttcgta aacagtcttc ttatttacga
601 tcaacatctt ctggagtctt tcttgagcga acacatttat atgtaaaaaat agaacatctt
661 ctagtagtgt gttgtaattc tttcagagg atcctatgct ttctcaagga tcctttcatg
721 cattatgttc gatatcaagg aaaagcaatt ctggcctcaa aggggaactct tattctgatg
781 aagaaatgga aatttcatct tgtgaatttt tggcaatctt attttcaactt ttggtctcaa
841 ccgtatagga ttcataataa gcaattatcc aactattcct tctcttttct ggggtatttt
901 tcaagtgtac tagaaaatca tttggtagta agaaatcaa tgctagagaa ttcatttata
961 ataaatcttc tgactaagaa attcgatacc atagccccag ttatttctct tattggatca
1021 ttgtcgaaag ctcaattttg tactgtattg ggtcatccta ttagtaaacc gatctggacc
1081 gatttctcgg attctgatat tcttgatcga ttttgccgga tatgtagaaa tctttgtcgt
1141 tatcacagcg gatcctcaa aaaacaggtt ttgtatcgt taaaatatat acttcgactt
1201 tcgtgtgcta gaactttggc acggaaacat aaaagtacag tacgcacttt tatgcaaga
1261 ttaggttcgg gattattaga agaattcttt atggaagaag aa

```

//

The argument `rettype="gb"` lets us download this record in the GenBank format. Note that until Easter 2009, the Entrez EFetch API let you use “genbank” as the return type, however the NCBI now insist on using the official return types of “gb” or “gbwithparts” (or “gp” for proteins) as described on online.

Alternatively, you could for example use `rettype="fasta"` to get the Fasta-format; see the [EFetch Sequences Help page](#) for other options. Remember – the available formats depend on which database you are downloading from - see the main [EFetch Help page](#).

If you fetch the record in one of the formats accepted by `Bio.SeqIO` (see Chapter 5), you could directly parse it into a `SeqRecord`:

```

>>> from Bio import Entrez, SeqIO
>>> handle = Entrez.efetch(db="nucleotide", id="186972394",rettype="gb")
>>> record = SeqIO.read(handle, "genbank")
>>> handle.close()
>>> print record
ID: EU490707.1
Name: EU490707
Description: Selenipedium aequinoctiale maturase K (matK) gene, partial cds; chloroplast.
Number of features: 3
...
Seq('ATTTTTTACGAACCTGTGAAATTTTTGGTTATGACAATAAATCTAGTTTAGTA...GAA', IUPACAmbiguousDNA())

```

Note that a more typical use would be to save the sequence data to a local file, and *then* parse it with `Bio.SeqIO`. This can save you having to re-download the same file repeatedly while working on your script, and places less load on the NCBI’s servers. For example:

```

import os
from Bio import SeqIO
from Bio import Entrez
Entrez.email = "A.N.Other@example.com" # Always tell NCBI who you are

```

```

filename = "gi_186972394.gbk"
if not os.path.isfile(filename):
    print "Downloading..."
    net_handle = Entrez.efetch(db="nucleotide",id="186972394",rettype="gb")
    out_handle = open(filename, "w")
    out_handle.write(net_handle.read())
    out_handle.close()
    net_handle.close()
    print "Saved"

print "Parsing..."
record = SeqIO.read(filename, "genbank")
print record

```

To get the output in XML format, which you can parse using the `Bio.Entrez.read()` function, use `retmode="xml"`:

```

>>> from Bio import Entrez
>>> handle = Entrez.efetch(db="nucleotide", id="186972394", retmode="xml")
>>> record = Entrez.read(handle)
>>> handle.close()
>>> record[0]["GBSeq_definition"]
'Selenipedium aequinoctiale maturase K (matK) gene, partial cds; chloroplast'
>>> record[0]["GBSeq_source"]
'chloroplast Selenipedium aequinoctiale'

```

So, that dealt with sequences. For examples of parsing file formats specific to the other databases (e.g. the MEDLINE format used in PubMed), see Section 8.11.

If you want to perform a search with `Bio.Entrez.esearch()`, and then download the records with `Bio.Entrez.efetch()`, you should use the WebEnv history feature – see Section 8.14.

8.7 ELink: Searching for related items in NCBI Entrez

ELink, available from Biopython as `Bio.Entrez.elink()`, can be used to find related items in the NCBI Entrez databases. For example, you can use this to find nucleotide entries for an entry in the gene database, and other cool stuff.

Let's use ELink to find articles related to the Biopython application note published in *Bioinformatics* in 2009. The PubMed ID of this article is 19304878:

```

>>> from Bio import Entrez
>>> Entrez.email = "A.N.Other@example.com"
>>> pmid = "19304878"
>>> record = Entrez.read(Entrez.elink(dbfrom="pubmed", id=pmid))

```

The `record` variable consists of a Python list, one for each database in which we searched. Since we specified only one PubMed ID to search for, `record` contains only one item. This item is a dictionary containing information about our search term, as well as all the related items that were found:

```

>>> record[0]["DbFrom"]
'pubmed'
>>> record[0]["IdList"]
['19304878']

```

The "LinkSetDb" key contains the search results, stored as a list consisting of one item for each target database. In our search results, we only find hits in the PubMed database (although sub-divided into categories):

```
>>> len(record[0]["LinkSetDb"])
5
>>> for linksetdb in record[0]["LinkSetDb"]:
...     print linksetdb["DbTo"], linksetdb["LinkName"], len(linksetdb["Link"])
...
pubmed pubmed_pubmed 110
pubmed pubmed_pubmed_combined 6
pubmed pubmed_pubmed_five 6
pubmed pubmed_pubmed_reviews 5
pubmed pubmed_pubmed_reviews_five 5
```

The actual search results are stored as under the "Link" key. In total, 110 items were found under standard search. Let's now at the first search result:

```
>>> record[0]["LinkSetDb"][0]["Link"][0]
{'u'Id': '19304878'}
```

This is the article we searched for, which doesn't help us much, so let's look at the second search result:

```
>>> record[0]["LinkSetDb"][0]["Link"][1]
{'u'Id': '14630660'}
```

This paper, with PubMed ID 14630660, is about the Biopython PDB parser.

We can use a loop to print out all PubMed IDs:

```
>>> for link in record[0]["LinkSetDb"][0]["Link"] : print link["Id"]
19304878
14630660
18689808
17121776
16377612
12368254
.....
```

Now that was nice, but personally I am often more interested to find out if a paper has been cited. Well, ELink can do that too – at least for journals in Pubmed Central (see Section 8.14.3).

For help on ELink, see the [ELink help page](#). There is an entire sub-page just for the [link names](#), describing how different databases can be cross referenced.

8.8 EGQuery: Global Query - counts for search terms

EGQuery provides counts for a search term in each of the Entrez databases (i.e. a global query). This is particularly useful to find out how many items your search terms would find in each database without actually performing lots of separate searches with ESearch (see the example in 8.13.2 below).

In this example, we use `Bio.Entrez.egquery()` to obtain the counts for "Biopython":

```
>>> from Bio import Entrez
>>> Entrez.email = "A.N.Other@example.com"      # Always tell NCBI who you are
>>> handle = Entrez.egquery(term="biopython")
>>> record = Entrez.read(handle)
```

```
>>> for row in record["eGQueryResult"]: print row["DbName"], row["Count"]
...
pubmed 6
pmc 62
journals 0
...
```

See the [EGQuery help page](#) for more information.

8.9 ESpell: Obtaining spelling suggestions

ESpell retrieves spelling suggestions. In this example, we use `Bio.Entrez.espell()` to obtain the correct spelling of Biopython:

```
>>> from Bio import Entrez
>>> Entrez.email = "A.N.Other@example.com"      # Always tell NCBI who you are
>>> handle = Entrez.espell(term="biopythooon")
>>> record = Entrez.read(handle)
>>> record["Query"]
'biopythooon'
>>> record["CorrectedQuery"]
'biopython'
```

See the [ESpell help page](#) for more information. The main use of this is for GUI tools to provide automatic suggestions for search terms.

8.10 Parsing huge Entrez XML files

The `Entrez.read` function reads the entire XML file returned by Entrez into a single Python object, which is kept in memory. To parse Entrez XML files too large to fit in memory, you can use the function `Entrez.parse`. This is a generator function that reads records in the XML file one by one. This function is only useful if the XML file reflects a Python list object (in other words, if `Entrez.read` on a computer with infinite memory resources would return a Python list).

For example, you can download the entire Entrez Gene database for a given organism as a file from NCBI's ftp site. These files can be very large. As an example, on September 4, 2009, the file `Homo_sapiens.ags.gz`, containing the Entrez Gene database for human, had a size of 116576 kB. This file, which is in the ASN format, can be converted into an XML file using NCBI's `gene2xml` program (see NCBI's ftp site for more information):

```
gene2xml -b T -i Homo_sapiens.ags -o Homo_sapiens.xml
```

The resulting XML file has a size of 6.1 GB. Attempting `Entrez.read` on this file will result in a `MemoryError` on many computers.

The XML file `Homo_sapiens.xml` consists of a list of Entrez gene records, each corresponding to one Entrez gene in human. `Entrez.parse` retrieves these gene records one by one. You can then print out or store the relevant information in each record by iterating over the records. For example, this script iterates over the Entrez gene records and prints out the gene numbers and names for all current genes:

```
>>> from Bio import Entrez
>>> handle = open("Homo_sapiens.xml")
>>> records = Entrez.parse(handle)
```

```

>>> for record in records:
...     status = record['Entrezgene_track-info']['Gene-track']['Gene-track_status']
...     if status.attributes['value']=='discontinued':
...         continue
...     geneid = record['Entrezgene_track-info']['Gene-track']['Gene-track_geneid']
...     genename = record['Entrezgene_gene']['Gene-ref']['Gene-ref_locus']
...     print geneid, genename

```

This will print:

```

1 A1BG
2 A2M
3 A2MP
8 AA
9 NAT1
10 NAT2
11 AACP
12 SERPINA3
13 AADAC
14 AAMP
15 AANAT
16 AARS
17 AAVS1
...

```

8.11 Specialized parsers

The `Bio.Entrez.read()` function can parse most (if not all) XML output returned by Entrez. Entrez typically allows you to retrieve records in other formats, which may have some advantages compared to the XML format in terms of readability (or download size).

To request a specific file format from Entrez using `Bio.Entrez.efetch()` requires specifying the `rettype` and/or `retmode` optional arguments. The different combinations are described for each database type on the [NCBI efetch webpage](#).

One obvious case is you may prefer to download sequences in the FASTA or GenBank/GenPept plain text formats (which can then be parsed with `Bio.SeqIO`, see Sections 5.2.1 and 8.6). For the literature databases, Biopython contains a parser for the MEDLINE format used in PubMed.

8.11.1 Parsing Medline records

You can find the Medline parser in `Bio.Medline`. Suppose we want to parse the file `pubmed_result1.txt`, containing one Medline record. You can find this file in Biopython's `Tests\Medline` directory. The file looks like this:

```

PMID- 12230038
OWN - NLM
STAT- MEDLINE
DA - 20020916
DCOM- 20030606
LR - 20041117
PUBM- Print
IS - 1467-5463 (Print)
VI - 3

```



```

IP - 3
DP - 2002 Sep
TI - The Bio* toolkits--a brief overview.
PG - 296-302
AB - Bioinformatics research is often difficult to do with commercial software. The
    Open Source BioPerl, BioPython and Biojava projects provide toolkits with
...

```

We first open the file and then parse it:

```

>>> from Bio import Medline
>>> input = open("pubmed_result1.txt")
>>> record = Medline.read(input)

```

The record now contains the Medline record as a Python dictionary:

```

>>> record["PMID"]
'12230038'
>>> record["AB"]
'Bioinformatics research is often difficult to do with commercial software.
The Open Source BioPerl, BioPython and Biojava projects provide toolkits with
multiple functionality that make it easier to create customised pipelines or
analysis. This review briefly compares the quirks of the underlying languages
and the functionality, documentation, utility and relative advantages of the
Bio counterparts, particularly from the point of view of the beginning
biologist programmer.'

```

The key names used in a Medline record can be rather obscure; use

```
>>> help(record)
```

for a brief summary.

To parse a file containing multiple Medline records, you can use the parse function instead:

```

>>> from Bio import Medline
>>> input = open("pubmed_result2.txt")
>>> records = Medline.parse(input)
>>> for record in records:
...     print record["TI"]

```

A high level interface to SCOP and ASTRAL implemented in python.

GenomeDiagram: a python package for the visualization of large-scale genomic data.

Open source clustering software.

PDB file parser and structure class implemented in Python.

Instead of parsing Medline records stored in files, you can also parse Medline records downloaded by Bio.Entrez.efetch. For example, let's look at all Medline records in PubMed related to Biopython:

```

>>> from Bio import Entrez
>>> Entrez.email = "A.N.Other@example.com"      # Always tell NCBI who you are
>>> handle = Entrez.esearch(db="pubmed",term="biopython")
>>> record = Entrez.read(handle)
>>> record["IdList"]
['19304878', '18606172', '16403221', '16377612', '14871861', '14630660', '12230038']

```

We now use Bio.Entrez.efetch to download these Medline records:

```
>>> idlist = record["IdList"]
>>> handle = Entrez.efetch(db="pubmed",id=idlist,rettype="medline",retmode="text")
```

Here, we specify `rettype="medline"`, `retmode="text"` to obtain the Medline records in plain-text Medline format. Now we use `Bio.Medline` to parse these records:

```
>>> from Bio import Medline
>>> records = Medline.parse(handle)
>>> for record in records:
...     print record["AU"]
['Cock PJ', 'Antao T', 'Chang JT', 'Chapman BA', 'Cox CJ', 'Dalke A', ..., 'de Hoon MJ']
['Munteanu CR', 'Gonzalez-Diaz H', 'Magalhaes AL']
['Casbon JA', 'Crooks GE', 'Saqi MA']
['Pritchard L', 'White JA', 'Birch PR', 'Toth IK']
['de Hoon MJ', 'Imoto S', 'Nolan J', 'Miyano S']
['Hamelryck T', 'Manderick B']
['Mangalam H']
```

For comparison, here we show an example using the XML format:

```
>>> idlist = record["IdList"]
>>> handle = Entrez.efetch(db="pubmed",id=idlist,rettype="medline",retmode="xml")
>>> records = Entrez.read(handle)
>>> for record in records:
...     print record["MedlineCitation"]["Article"]["ArticleTitle"]
Biopython: freely available Python tools for computational molecular biology and
  bioinformatics.
Enzymes/non-enzymes classification model complexity based on composition, sequence,
  3D and topological indices.
A high level interface to SCOP and ASTRAL implemented in python.
GenomeDiagram: a python package for the visualization of large-scale genomic data.
Open source clustering software.
PDB file parser and structure class implemented in Python.
The Bio* toolkits--a brief overview.
```

Note that in both of these examples, for simplicity we have naively combined `ESearch` and `EFetch`. In this situation, the NCBI would expect you to use their history feature, as illustrated in [Section 8.14](#).

8.11.2 Parsing GEO records

GEO ([Gene Expression Omnibus](#)) is a data repository of high-throughput gene expression and hybridization array data. The `Bio.Geo` module can be used to parse GEO-formatted data.

The following code fragment shows how to parse the example GEO file `GSE16.txt` into a record and print the record:

```
>>> from Bio import Geo
>>> handle = open("GSE16.txt")
>>> records = Geo.parse(handle)
>>> for record in records:
...     print record
```

You can search the “gds” database (GEO datasets) with `ESearch`:

```

>>> from Bio import Entrez
>>> Entrez.email = "A.N.Other@example.com" # Always tell NCBI who you are
>>> handle = Entrez.esearch(db="gds",term="GSE16")
>>> record = Entrez.read(handle)
>>> record["Count"]
2
>>> record["IdList"]
['200000016', '100000028']

```

From the Entrez website, UID “200000016” is GDS16 while the other hit “100000028” is for the associated platform, GPL28. Unfortunately, at the time of writing the NCBI don’t seem to support downloading GEO files using Entrez (not as XML, nor in the *Simple Omnibus Format in Text* (SOFT) format).

However, it is actually pretty straight forward to download the GEO files by FTP from <ftp://ftp.ncbi.nih.gov/pub/geo/> instead. In this case you might want ftp://ftp.ncbi.nih.gov/pub/geo/DATA/SOFT/by_series/GSE16/GSE16_family.soft.gz (a compressed file, see the Python module `gzip`).

8.11.3 Parsing UniGene records

UniGene is an NCBI database of the transcriptome, with each UniGene record showing the set of transcripts that are associated with a particular gene in a specific organism. A typical UniGene record looks like this:

```

ID          Hs.2
TITLE       N-acetyltransferase 2 (arylamine N-acetyltransferase)
GENE        NAT2
CYTOBAND    8p22
GENE_ID     10
LOCUSLINK   10
HOMOL       YES
EXPRESS     bone| connective tissue| intestine| liver| liver tumor| normal| soft tissue/muscle tissue
RESTR_EXPR  adult
CHROMOSOME  8
STS         ACC=PMC310725P3 UNISTS=272646
STS         ACC=WIAF-2120 UNISTS=44576
STS         ACC=G59899 UNISTS=137181
...
STS         ACC=GDB:187676 UNISTS=155563
PROTSIM     ORG=10090; PROTG1=6754794; PROTIID=NP_035004.1; PCT=76.55; ALN=288
PROTSIM     ORG=9796; PROTG1=149742490; PROTIID=XP_001487907.1; PCT=79.66; ALN=288
PROTSIM     ORG=9986; PROTG1=126722851; PROTIID=NP_001075655.1; PCT=76.90; ALN=288
...
PROTSIM     ORG=9598; PROTG1=114619004; PROTIID=XP_519631.2; PCT=98.28; ALN=288

SCOUNT      38
SEQUENCE    ACC=BC067218.1; NID=g45501306; PID=g45501307; SEQTYPE=mRNA
SEQUENCE    ACC=NM_000015.2; NID=g116295259; PID=g116295260; SEQTYPE=mRNA
SEQUENCE    ACC=D90042.1; NID=g219415; PID=g219416; SEQTYPE=mRNA
SEQUENCE    ACC=D90040.1; NID=g219411; PID=g219412; SEQTYPE=mRNA
SEQUENCE    ACC=BC015878.1; NID=g16198419; PID=g16198420; SEQTYPE=mRNA
SEQUENCE    ACC=CR407631.1; NID=g47115198; PID=g47115199; SEQTYPE=mRNA
SEQUENCE    ACC=BG569293.1; NID=g13576946; CLONE=IMAGE:4722596; END=5'; LID=6989; SEQTYPE=EST; TRACE=44
...
SEQUENCE    ACC=AU099534.1; NID=g13550663; CLONE=HSI08034; END=5'; LID=8800; SEQTYPE=EST
//

```

This particular record shows the set of transcripts (shown in the `SEQUENCE` lines) that originate from the human gene NAT2, encoding an N-acetyltransferase. The `PROTSIM` lines show proteins with significant similarity to NAT2, whereas the `STS` lines show the corresponding sequence-tagged sites in the genome.

To parse UniGene files, use the `Bio.UniGene` module:

```
>>> from Bio import UniGene
>>> input = open("myunigenefile.data")
>>> record = UniGene.read(input)
```

The `record` returned by `UniGene.read` is a Python object with attributes corresponding to the fields in the UniGene record. For example,

```
>>> record.ID
"Hs.2"
>>> record.title
"N-acetyltransferase 2 (arylamine N-acetyltransferase)"
```

The `EXPRESS` and `RESTR_EXPR` lines are stored as Python lists of strings:

```
['bone', 'connective tissue', 'intestine', 'liver', 'liver tumor', 'normal', 'soft tissue/muscle tissue
```

Specialized objects are returned for the `STS`, `PROTSIM`, and `SEQUENCE` lines, storing the keys shown in each line as attributes:

```
>>> record.sts[0].acc
'PMC310725P3'
>>> record.sts[0].unists
'272646'
```

and similarly for the `PROTSIM` and `SEQUENCE` lines.

To parse a file containing more than one UniGene record, use the `parse` function in `Bio.UniGene`:

```
>>> from Bio import UniGene
>>> input = open("unigenerecords.data")
>>> records = UniGene.parse(input)
>>> for record in records:
...     print record.ID
```

8.12 Using a proxy

Normally you won't have to worry about using a proxy, but if this is an issue on your network here is how to deal with it. Internally, `Bio.Entrez` uses the standard Python library `urllib` for accessing the NCBI servers. This will check an environment variable called `http_proxy` to configure any simple proxy automatically. Unfortunately this module does not support the use of proxies which require authentication.

You may choose to set the `http_proxy` environment variable once (how you do this will depend on your operating system). Alternatively you can set this within Python at the start of your script, for example:

```
import os
os.environ["http_proxy"] = "http://proxyhost.example.com:8080"
```

See the [urllib documentation](#) for more details.

8.13 Examples

8.13.1 PubMed and Medline

If you are in the medical field or interested in human issues (and many times even if you are not!), PubMed (<http://www.ncbi.nlm.nih.gov/PubMed/>) is an excellent source of all kinds of goodies. So like other things, we'd like to be able to grab information from it and use it in Python scripts.

In this example, we will query PubMed for all articles having to do with orchids (see section 2.3 for our motivation). We first check how many of such articles there are:

```
>>> from Bio import Entrez
>>> Entrez.email = "A.N.Other@example.com"      # Always tell NCBI who you are
>>> handle = Entrez.egquery(term="orchid")
>>> record = Entrez.read(handle)
>>> for row in record["eGQueryResult"]:
...     if row["DbName"]=="pubmed":
...         print row["Count"]
463
```

Now we use the `Bio.Entrez.efetch` function to download the PubMed IDs of these 463 articles:

```
>>> handle = Entrez.esearch(db="pubmed", term="orchid", retmax=463)
>>> record = Entrez.read(handle)
>>> idlist = record["IdList"]
>>> print idlist
```

This returns a Python list containing all of the PubMed IDs of articles related to orchids:

```
['18680603', '18665331', '18661158', '18627489', '18627452', '18612381',
'18594007', '18591784', '18589523', '18579475', '18575811', '18575690',
...]
```

Now that we've got them, we obviously want to get the corresponding Medline records and extract the information from them. Here, we'll download the Medline records in the Medline flat-file format, and use the `Bio.Medline` module to parse them:

```
>>> from Bio import Medline
>>> handle = Entrez.efetch(db="pubmed", id=idlist, rettype="medline",
                          retmode="text")
>>> records = Medline.parse(handle)
```

NOTE - We've just done a separate search and fetch here, the NCBI much prefer you to take advantage of their history support in this situation. See Section 8.14.

Keep in mind that `records` is an iterator, so you can iterate through the records only once. If you want to save the records, you can convert them to a list:

```
>>> records = list(records)
```

Let's now iterate over the records to print out some information about each record:

```
>>> for record in records:
...     print "title:", record.get("TI", "?")
...     print "authors:", record.get("AU", "?")
...     print "source:", record.get("CO", "?")
...     print
```

The output for this looks like:

```

title: Sex pheromone mimicry in the early spider orchid (ophrys sphegodes):
patterns of hydrocarbons as the key mechanism for pollination by sexual
deception [In Process Citation]
authors: ['Schiestl FP', 'Ayasse M', 'Paulus HF', 'Lofstedt C', 'Hansson BS',
'Ibarra F', 'Francke W']
source: J Comp Physiol [A] 2000 Jun;186(6):567-74

```

Especially interesting to note is the list of authors, which is returned as a standard Python list. This makes it easy to manipulate and search using standard Python tools. For instance, we could loop through a whole bunch of entries searching for a particular author with code like the following:

```

>>> search_author = "Waits T"

>>> for record in records:
...     if not "AU" in record:
...         continue
...     if search_author in record["AU"]:
...         print "Author %s found: %s" % (search_author, record["SO"])

```

Hopefully this section gave you an idea of the power and flexibility of the Entrez and Medline interfaces and how they can be used together.

8.13.2 Searching, downloading, and parsing Entrez Nucleotide records

Here we'll show a simple example of performing a remote Entrez query. In section 2.3 of the parsing examples, we talked about using NCBI's Entrez website to search the NCBI nucleotide databases for info on Cypripedioideae, our friends the lady slipper orchids. Now, we'll look at how to automate that process using a Python script. In this example, we'll just show how to connect, get the results, and parse them, with the Entrez module doing all of the work.

First, we use EGQuery to find out the number of results we will get before actually downloading them. EGQuery will tell us how many search results were found in each of the databases, but for this example we are only interested in nucleotides:

```

>>> from Bio import Entrez
>>> Entrez.email = "A.N.Other@example.com" # Always tell NCBI who you are
>>> handle = Entrez.egquery(term="Cypripedioideae")
>>> record = Entrez.read(handle)
>>> for row in record["eGQueryResult"]:
...     if row["DbName"]=="nuccore":
...         print row["Count"]
814

```

So, we expect to find 814 Entrez Nucleotide records (this is the number I obtained in 2008; it is likely to increase in the future). If you find some ridiculously high number of hits, you may want to reconsider if you really want to download all of them, which is our next step:

```

>>> from Bio import Entrez
>>> handle = Entrez.esearch(db="nucleotide", term="Cypripedioideae", retmax=814)
>>> record = Entrez.read(handle)

```

Here, `record` is a Python dictionary containing the search results and some auxiliary information. Just for information, let's look at what is stored in this dictionary:

```

>>> print record.keys()
[u'Count', u'RetMax', u'IdList', u'TranslationSet', u'RetStart', u'QueryTranslation']

```

First, let's check how many results were found:

```
>>> print record["Count"]
'814'
```

which is the number we expected. The 814 results are stored in `record['IdList']`:

```
>>> print len(record["IdList"])
814
```

Let's look at the first five results:

```
>>> print record["IdList"][:5]
['187237168', '187372713', '187372690', '187372688', '187372686']
```

We can download these records using `efetch`. While you could download these records one by one, to reduce the load on NCBI's servers, it is better to fetch a bunch of records at the same time, shown below. However, in this situation you should ideally be using the history feature described later in Section 8.14.

```
>>> idlist = ",".join(record["IdList"][:5])
>>> print idlist
187237168,187372713,187372690,187372688,187372686
>>> handle = Entrez.efetch(db="nucleotide", id=idlist, retmode="xml")
>>> records = Entrez.read(handle)
>>> print len(records)
5
```

Each of these records corresponds to one GenBank record.

```
>>> print records[0].keys()
[u'GBSeq_moltype', u'GBSeq_source', u'GBSeq_sequence',
 u'GBSeq_primary-accession', u'GBSeq_definition', u'GBSeq_accession-version',
 u'GBSeq_topology', u'GBSeq_length', u'GBSeq_feature-table',
 u'GBSeq_create-date', u'GBSeq_other-seqids', u'GBSeq_division',
 u'GBSeq_taxonomy', u'GBSeq_references', u'GBSeq_update-date',
 u'GBSeq_organism', u'GBSeq_locus', u'GBSeq_strandedness']

>>> print records[0]["GBSeq_primary-accession"]
DQ110336

>>> print records[0]["GBSeq_other-seqids"]
['gb|DQ110336.1|', 'gi|187237168']

>>> print records[0]["GBSeq_definition"]
Cypripedium calceolus voucher Davis 03-03 A maturase (matR) gene, partial cds;
mitochondrial

>>> print records[0]["GBSeq_organism"]
Cypripedium calceolus
```

You could use this to quickly set up searches – but for heavy usage, see Section 8.14.

8.13.3 Searching, downloading, and parsing GenBank records

The GenBank record format is a very popular method of holding information about sequences, sequence features, and other associated sequence information. The format is a good way to get information from the NCBI databases at <http://www.ncbi.nlm.nih.gov/>.

In this example we'll show how to query the NCBI databases, to retrieve the records from the query, and then parse them using `Bio.SeqIO` - something touched on in Section 5.2.1. For simplicity, this example *does not* take advantage of the `WebEnv` history feature - see Section 8.14 for this.

First, we want to make a query and find out the ids of the records to retrieve. Here we'll do a quick search for one of our favorite organisms, *Opuntia* (prickly-pear cacti). We can do quick search and get back the GIs (GenBank identifiers) for all of the corresponding records. First we check how many records there are:

```
>>> from Bio import Entrez
>>> Entrez.email = "A.N.Other@example.com"      # Always tell NCBI who you are
>>> handle = Entrez.egquery(term="Opuntia AND rpl16")
>>> record = Entrez.read(handle)
>>> for row in record["eGQueryResult"]:
...     if row["DbName"]=="nuccore":
...         print row["Count"]
...
9
```

Now we download the list of GenBank identifiers:

```
>>> handle = Entrez.esearch(db="nuccore", term="Opuntia AND rpl16")
>>> record = Entrez.read(handle)
>>> gi_list = record["IdList"]
>>> gi_list
['57240072', '57240071', '6273287', '6273291', '6273290', '6273289', '6273286',
'6273285', '6273284']
```

Now we use these GIs to download the GenBank records - note that you have to supply a comma separated list of GI numbers to Entrez:

```
>>> gi_str = ",".join(gi_list)
>>> handle = Entrez.efetch(db="nuccore", id=gi_str, rettype="gb")
```

If you want to look at the raw GenBank files, you can read from this handle and print out the result:

```
>>> text = handle.read()
>>> print text
LOCUS      AY851612                892 bp    DNA        linear    PLN 10-APR-2007
DEFINITION Opuntia subulata rpl16 gene, intron; chloroplast.
ACCESSION  AY851612
VERSION    AY851612.1  GI:57240072
KEYWORDS   .
SOURCE     chloroplast Austrocyllindropuntia subulata
  ORGANISM Austrocyllindropuntia subulata
            Eukaryota; Viridiplantae; Streptophyta; Embryophyta; Tracheophyta;
            Spermatophyta; Magnoliophyta; eudicotyledons; core eudicotyledons;
            Caryophyllales; Cactaceae; Opuntioideae; Austrocyllindropuntia.
REFERENCE  1 (bases 1 to 892)
  AUTHORS  Butterworth,C.A. and Wallace,R.S.
...
```

In this case, we are just getting the raw records. To get the records in a more Python-friendly form, we can use `Bio.SeqIO` to parse the GenBank data into `SeqRecord` objects, including `SeqFeature` objects (see Chapter 5):

```
>>> from Bio import SeqIO
>>> handle = Entrez.efetch(db="nuccore", id=gi_str, rettype="gb")
>>> records = SeqIO.parse(handle, "gb")
```

We can now step through the records and look at the information we are interested in:

```
>>> for record in records:
>>> ...     print "%s, length %i, with %i features" \
>>> ...         % (record.name, len(record), len(record.features))
AY851612, length 892, with 3 features
AY851611, length 881, with 3 features
AF191661, length 895, with 3 features
AF191665, length 902, with 3 features
AF191664, length 899, with 3 features
AF191663, length 899, with 3 features
AF191660, length 893, with 3 features
AF191659, length 894, with 3 features
AF191658, length 896, with 3 features
```

Using these automated query retrieval functionality is a big plus over doing things by hand. Although the module should obey the NCBI's max three queries per second rule, the NCBI have other recommendations like avoiding peak hours. See Section 8.1. In particular, please note that for simplicity, this example does not use the WebEnv history feature. You should use this for any non-trivial search and download work, see Section 8.14.

Finally, if plan to repeat your analysis, rather than downloading the files from the NCBI and parsing them immediately (as shown in this example), you should just download the records *once* and save them to your hard disk, and then parse the local file.

8.13.4 Finding the lineage of an organism

Staying with a plant example, let's now find the lineage of the Cyprapedioideae orchid family. First, we search the Taxonomy database for Cyprapedioideae, which yields exactly one NCBI taxonomy identifier:

```
>>> from Bio import Entrez
>>> Entrez.email = "A.N.Other@example.com"      # Always tell NCBI who you are
>>> handle = Entrez.esearch(db="Taxonomy", term="Cyprapedioideae")
>>> record = Entrez.read(handle)
>>> record["IdList"]
['158330']
>>> record["IdList"][0]
'158330'
```

Now, we use `efetch` to download this entry in the Taxonomy database, and then parse it:

```
>>> handle = Entrez.efetch(db="Taxonomy", id="158330", retmode="xml")
>>> records = Entrez.read(handle)
```

Again, this record stores lots of information:

```
>>> records[0].keys()
[u'Lineage', u'Division', u'ParentTaxId', u'PubDate', u'LineageEx',
 u'CreateDate', u'TaxId', u'Rank', u'GeneticCode', u'ScientificName',
 u'MitoGeneticCode', u'UpdateDate']
```

We can get the lineage directly from this record:

```
>>> records[0]["Lineage"]
'cellular organisms; Eukaryota; Viridiplantae; Streptophyta; Streptophytina;
Embryophyta; Tracheophyta; Euphyllophyta; Spermatophyta; Magnoliophyta;
Liliopsida; Asparagales; Orchidaceae'
```

The record data contains much more than just the information shown here - for example look under "LineageEx" instead of "Lineage" and you'll get the NCBI taxon identifiers of the lineage entries too.

8.14 Using the history and WebEnv

Often you will want to make a series of linked queries. Most typically, running a search, perhaps refining the search, and then retrieving detailed search results. You *can* do this by making a series of separate calls to Entrez. However, the NCBI prefer you to take advantage of their history support - for example combining ESearch and EFetch.

Another typical use of the history support would be to combine EPost and EFetch. You use EPost to upload a list of identifiers, which starts a new history session. You then download the records with EFetch by referring to the session (instead of the identifiers).

8.14.1 Searching for and downloading sequences using the history

Suppose we want to search and download all the *Opuntia* rpl16 nucleotide sequences, and store them in a FASTA file. As shown in Section 8.13.3, we can naively combine `Bio.Entrez.esearch()` to get a list of GI numbers, and then call `Bio.Entrez.efetch()` to download them all.

However, the approved approach is to run the search with the history feature. Then, we can fetch the results by reference to the search results - which the NCBI can anticipate and cache.

To do this, call `Bio.Entrez.esearch()` as normal, but with the additional argument of `usehistory="y"`,

```
>>> from Bio import Entrez
>>> Entrez.email = "history.user@example.com"
>>> search_handle = Entrez.esearch(db="nucleotide",term="Opuntia[orgn] and rpl16",
                                usehistory="y")
>>> search_results = Entrez.read(search_handle)
>>> search_handle.close()
```

When you get the XML output back, it will still include the usual search results:

```
>>> gi_list = search_results["IdList"]
>>> count = int(search_results["Count"])
>>> assert count == len(gi_list)
```

However, you also get given two additional pieces of information, the `WebEnv` session cookie, and the `QueryKey`:

```
>>> webenv = search_results["WebEnv"]
>>> query_key = search_results["QueryKey"]
```

Having stored these values in variables `session_cookie` and `query_key` we can use them as parameters to `Bio.Entrez.efetch()` instead of giving the GI numbers as identifiers.

While for small searches you might be OK downloading everything at once, its better download in batches. You use the `retstart` and `retmax` parameters to specify which range of search results you want returned (starting entry using zero-based counting, and maximum number of results to return). For example,

```

batch_size = 3
out_handle = open("orchid_rpl16.fasta", "w")
for start in range(0, count, batch_size):
    end = min(count, start+batch_size)
    print "Going to download record %i to %i" % (start+1, end)
    fetch_handle = Entrez.efetch(db="nucleotide", rettype="fasta",
                                retstart=start, retmax=batch_size,
                                webenv=webenv, query_key=query_key)

    data = fetch_handle.read()
    fetch_handle.close()
    out_handle.write(data)
out_handle.close()

```

For illustrative purposes, this example downloaded the FASTA records in batches of three. Unless you are downloading genomes or chromosomes, you would normally pick a larger batch size.

8.14.2 Searching for and downloading abstracts using the history

Here is another history example, searching for papers published in the last year about the *Opuntia*, and then downloading them into a file in MedLine format:

```

from Bio import Entrez
Entrez.email = "history.user@example.com"
search_results = Entrez.read(Entrez.esearch(db="pubmed",
                                           term="Opuntia[ORGN]",
                                           reldate=365, datetype="pdat",
                                           usehistory="y"))

count = int(search_results["Count"])
print "Found %i results" % count

batch_size = 10
out_handle = open("recent_orchid_papers.txt", "w")
for start in range(0, count, batch_size):
    end = min(count, start+batch_size)
    print "Going to download record %i to %i" % (start+1, end)
    fetch_handle = Entrez.efetch(db="pubmed", rettype="medline",
                                retstart=start, retmax=batch_size,
                                webenv=search_results["WebEnv"],
                                query_key=search_results["QueryKey"])

    data = fetch_handle.read()
    fetch_handle.close()
    out_handle.write(data)
out_handle.close()

```

At the time of writing, this gave 28 matches - but because this is a date dependent search, this will of course vary. As described in Section 8.11.1 above, you can then use `Bio.Medline` to parse the saved records.

8.14.3 Searching for citations

Back in Section 8.7 we mentioned ELink can be used to search for citations of a given paper. Unfortunately this only covers journals indexed for PubMed Central (doing it for all the journals in PubMed would mean a lot more work for the NIH). Let's try this for the Biopython PDB parser paper, PubMed ID 14630660:

```

>>> from Bio import Entrez
>>> Entrez.email = "A.N.Other@example.com"
>>> pmid = "14630660"
>>> results = Entrez.read(Entrez.elink(dbfrom="pubmed", db="pmc",
...                               LinkName="pubmed_pmc_refs", from_uid=pmid))
>>> pmc_ids = [link["Id"] for link in results[0]["LinkSetDb"][0]["Link"]]
>>> pmc_ids
['2744707', '2705363', '2682512', ..., '1190160']

```

Great - eleven articles. But why hasn't the Biopython application note been found (PubMed ID 19304878)? Well, as you might have guessed from the variable names, there are not actually PubMed IDs, but PubMed Central IDs. Our application note is the third citing paper in that list, PMCID 2682512.

So, what if (like me) you'd rather get back a list of PubMed IDs? Well we can call ELink again to translate them. This becomes a two step process, so by now you should expect to use the history feature to accomplish it (Section 8.14).

But first, taking the more straightforward approach of making a second (separate) call to ELink:

```

>>> results2 = Entrez.read(Entrez.elink(dbfrom="pmc", db="pubmed", LinkName="pmc_pubmed",
...                               from_uid=",".join(pmc_ids)))
>>> pubmed_ids = [link["Id"] for link in results2[0]["LinkSetDb"][0]["Link"]]
>>> pubmed_ids
['19698094', '19450287', '19304878', ..., '15985178']

```

This time you can immediately spot the Biopython application note as the third hit (PubMed ID 19304878).

Now, let's do that all again but with the history ... *TODO*.

And finally, don't forget to include your *own* email address in the Entrez calls.

Chapter 9

Swiss-Prot and ExPASy

9.1 Parsing Swiss-Prot files

Swiss-Prot (<http://www.expasy.org/sprot>) is a hand-curated database of protein sequences. Biopython can parse the “plain text” Swiss-Prot file format, which is still used for the UniProt Knowledgebase which combined Swiss-Prot, TrEMBL and PIR-PSD. We do not (yet) support the UniProtKB XML file format.

9.1.1 Parsing Swiss-Prot records

In Section 5.2.2, we described how to extract the sequence of a Swiss-Prot record as a `SeqRecord` object. Alternatively, you can store the Swiss-Prot record in a `Bio.SwissProt.Record` object, which in fact stores the complete information contained in the Swiss-Prot record. In this Section, we describe how to extract `Bio.SwissProt.Record` objects from a Swiss-Prot file.

To parse a Swiss-Prot record, we first get a handle to a Swiss-Prot record. There are several ways to do so, depending on where and how the Swiss-Prot record is stored:

- Open a Swiss-Prot file locally:

```
>>> handle = open("myswissprotfile.dat")
```
- Open a gzipped Swiss-Prot file:

```
>>> import gzip
>>> handle = gzip.open("myswissprotfile.dat.gz")
```
- Open a Swiss-Prot file over the internet:

```
>>> import urllib
>>> handle = urllib.urlopen("http://www.somelocation.org/data/someswissprotfile.dat")
```
- Open a Swiss-Prot file over the internet from the ExPASy database (see section 9.5.1):

```
>>> from Bio import ExPASy
>>> handle = ExPASy.get_sprot_raw(myaccessionnumber)
```

The key point is that for the parser, it doesn't matter how the handle was created, as long as it points to data in the Swiss-Prot format.

We can use `Bio.SeqIO` as described in Section 5.2.2 to get file format agnostic `SeqRecord` objects. Alternatively, we can use `Bio.SwissProt` get `Bio.SwissProt.Record` objects, which are a much closer match to the underlying file format.

To read one Swiss-Prot record from the handle, we use the function `read()`:

```
>>> from Bio import SwissProt
>>> record = SwissProt.read(handle)
```

This function should be used if the handle points to exactly one Swiss-Prot record. It raises a `ValueError` if no Swiss-Prot record was found, and also if more than one record was found.

We can now print out some information about this record:

```
>>> print record.description
'RecName: Full=Chalcone synthase 3; EC=2.3.1.74; AltName: Full=Naringenin-chalcone synthase 3;'
>>> for ref in record.references:
...     print "authors:", ref.authors
...     print "title:", ref.title
...
authors: Liew C.F., Lim S.H., Loh C.S., Goh C.J.;
title: "Molecular cloning and sequence analysis of chalcone synthase cDNAs of
Bromheadia finlaysoniana.";
>>> print record.organism_classification
['Eukaryota', 'Viridiplantae', 'Streptophyta', 'Embryophyta', ..., 'Bromheadia']
```

To parse a file that contains more than one Swiss-Prot record, we use the `parse` function instead. This function allows us to iterate over the records in the file.

For example, let's parse the full Swiss-Prot database and collect all the descriptions. You can download this from the [ExPAYS FTP site](#) as a single gzipped-file `uniprot_sprot.dat.gz` (about 300MB). This is a compressed file containing a single file, `uniprot_sprot.dat` (over 1.5GB).

As described at the start of this section, you can use the Python library `gzip` to open and uncompress a `.gz` file, like this:

```
>>> import gzip
>>> handle = gzip.open("uniprot_sprot.dat.gz")
```

However, uncompressing a large file takes time, and each time you open the file for reading in this way, it has to be decompressed on the fly. So, if you can spare the disk space you'll save time in the long run if you first decompress the file to disk, to get the `uniprot_sprot.dat` file inside. Then you can open the file for reading as usual:

```
>>> handle = open("uniprot_sprot.dat")
```

As of June 2009, the full Swiss-Prot database downloaded from ExPASy contained 468851 Swiss-Prot records. One concise way to build up a list of the record descriptions is with a list comprehension:

```
>>> from Bio import SwissProt
>>> handle = open("uniprot_sprot.dat")
>>> descriptions = [record.description for record in SwissProt.parse(handle)]
>>> len(descriptions)
468851
>>> descriptions[:5]
['RecName: Full=Protein MGF 100-1R;',
 'RecName: Full=Protein MGF 100-1R;',
 'RecName: Full=Protein MGF 100-1R;',
 'RecName: Full=Protein MGF 100-1R;',
 'RecName: Full=Protein MGF 100-2L;']
```

Or, using a for loop over the record iterator:

```

>>> from Bio import SwissProt
>>> descriptions = []
>>> handle = open("uniprot_sprot.dat")
>>> for record in SwissProt.parse(handle):
...     descriptions.append(record.description)
...
>>> len(descriptions)
468851

```

Because this is such a large input file, either way takes about eleven minutes on my new desktop computer (using the uncompressed `uniprot_sprot.dat` file as input).

It is equally easy to extract any kind of information you'd like from Swiss-Prot records. To see the members of a Swiss-Prot record, use

```

>>> dir(record)
['_doc__', '__init__', '__module__', 'accessions', 'annotation_update',
'comments', 'created', 'cross_references', 'data_class', 'description',
'entry_name', 'features', 'gene_name', 'host_organism', 'keywords',
'molecule_type', 'organelle', 'organism', 'organism_classification',
'references', 'seqinfo', 'sequence', 'sequence_length',
'sequence_update', 'taxonomy_id']

```

9.1.2 Parsing the Swiss-Prot keyword and category list

Swiss-Prot also distributes a file `keywlist.txt`, which lists the keywords and categories used in Swiss-Prot. The file contains entries in the following form:

```

ID  2Fe-2S.
AC  KW-0001
DE  Protein which contains at least one 2Fe-2S iron-sulfur cluster: 2 iron
DE  atoms complexed to 2 inorganic sulfides and 4 sulfur atoms of
DE  cysteines from the protein.
SY  Fe2S2; [2Fe-2S] cluster; [Fe2S2] cluster; Fe2/S2 (inorganic) cluster;
SY  Di-mu-sulfido-diiron; 2 iron, 2 sulfur cluster binding.
GO  G0:0051537; 2 iron, 2 sulfur cluster binding
HI  Ligand: Iron; Iron-sulfur; 2Fe-2S.
HI  Ligand: Metal-binding; 2Fe-2S.
CA  Ligand.
//
ID  3D-structure.
AC  KW-0002
DE  Protein, or part of a protein, whose three-dimensional structure has
DE  been resolved experimentally (for example by X-ray crystallography or
DE  NMR spectroscopy) and whose coordinates are available in the PDB
DE  database. Can also be used for theoretical models.
HI  Technical term: 3D-structure.
CA  Technical term.
//
ID  3Fe-4S.
...

```

The entries in this file can be parsed by the `parse` function in the `Bio.SwissProt.KeyWList` module. Each entry is then stored as a `Bio.SwissProt.KeyWList.Record`, which is a Python dictionary.

```

>>> from Bio.SwissProt import KeyWList
>>> handle = open("keywlist.txt")
>>> records = KeyWList.parse(handle)
>>> for record in records:
...     print record['ID']
...     print record['DE']

```

This prints

```

2Fe-2S.
Protein which contains at least one 2Fe-2S iron-sulfur cluster: 2 iron atoms
complexed to 2 inorganic sulfides and 4 sulfur atoms of cysteines from the
protein.
...

```

9.2 Parsing Prosite records

Prosite is a database containing protein domains, protein families, functional sites, as well as the patterns and profiles to recognize them. Prosite was developed in parallel with Swiss-Prot. In Biopython, a Prosite record is represented by the `Bio.ExPASy.Prosite.Record` class, whose members correspond to the different fields in a Prosite record.

In general, a Prosite file can contain more than one Prosite records. For example, the full set of Prosite records, which can be downloaded as a single file (`prosite.dat`) from the [ExPASy FTP site](#), contains 2073 records (version 20.24 released on 4 December 2007). To parse such a file, we again make use of an iterator:

```

>>> from Bio.ExPASy import Prosite
>>> handle = open("myprositefile.dat")
>>> records = Prosite.parse(handle)

```

We can now take the records one at a time and print out some information. For example, using the file containing the complete Prosite database, we'd find

```

>>> from Bio.ExPASy import Prosite
>>> handle = open("prosite.dat")
>>> records = Prosite.parse(handle)
>>> record = records.next()
>>> record.accession
'PS00001'
>>> record.name
'ASN_GLYCOSYLATION'
>>> record.pdoc
'PDOC00001'
>>> record = records.next()
>>> record.accession
'PS00004'
>>> record.name
'CAMP_PHOSPHO_SITE'
>>> record.pdoc
'PDOC00004'
>>> record = records.next()
>>> record.accession
'PS00005'

```



```
>>> record.name
'PKC_PHOSPHO_SITE'
>>> record.pdoc
'PDOC00005'
```

and so on. If you're interested in how many Prosite records there are, you could use

```
>>> from Bio.ExPASy import Prosite
>>> handle = open("prosite.dat")
>>> records = Prosite.parse(handle)
>>> n = 0
>>> for record in records: n+=1
...
>>> print n
2073
```

To read exactly one Prosite from the handle, you can use the `read` function:

```
>>> from Bio.ExPASy import Prosite
>>> handle = open("mysingleprositerecord.dat")
>>> record = Prosite.read(handle)
```

This function raises a `ValueError` if no Prosite record is found, and also if more than one Prosite record is found.

9.3 Parsing Prosite documentation records

In the Prosite example above, the `record.pdoc` accession numbers `'PDOC00001'`, `'PDOC00004'`, `'PDOC00005'` and so on refer to Prosite documentation. The Prosite documentation records are available from ExPASy as individual files, and as one file (`prosite.doc`) containing all Prosite documentation records.

We use the parser in `Bio.ExPASy.Prodoc` to parse Prosite documentation records. For example, to create a list of all accession numbers of Prosite documentation record, you can use

```
>>> from Bio.ExPASy import Prodoc
>>> handle = open("prosite.doc")
>>> records = Prodoc.parse(handle)
>>> accessions = [record.accession for record in records]
```

Again a `read()` function is provided to read exactly one Prosite documentation record from the handle.

9.4 Parsing Enzyme records

ExPASy's Enzyme database is a repository of information on enzyme nomenclature. A typical Enzyme record looks as follows:

```
ID  3.1.1.34
DE  Lipoprotein lipase.
AN  Clearing factor lipase.
AN  Diacylglycerol lipase.
AN  Diglyceride lipase.
CA  Triacylglycerol + H(2)O = diacylglycerol + a carboxylate.
CC  -!- Hydrolyzes triacylglycerols in chylomicrons and very low-density
CC      lipoproteins (VLDL).
```

```

CC  -!- Also hydrolyzes diacylglycerol.
PR  PROSITE; PDOC00110;
DR  P11151, LIPL_BOVIN ; P11153, LIPL_CAVPO ; P11602, LIPL_CHICK ;
DR  P55031, LIPL_FELCA ; P06858, LIPL_HUMAN ; P11152, LIPL_MOUSE ;
DR  046647, LIPL_MUSVI ; P49060, LIPL_PAPAN ; P49923, LIPL_PIG ;
DR  Q06000, LIPL_RAT ; Q29524, LIPL_SHEEP ;
//

```

In this example, the first line shows the EC (Enzyme Commission) number of lipoprotein lipase (second line). Alternative names of lipoprotein lipase are "clearing factor lipase", "diacylglycerol lipase", and "diglyceride lipase" (lines 3 through 5). The line starting with "CA" shows the catalytic activity of this enzyme. Comment lines start with "CC". The "PR" line shows references to the Prosite Documentation records, and the "DR" lines show references to Swiss-Prot records. Not of these entries are necessarily present in an Enzyme record.

In Biopython, an Enzyme record is represented by the `Bio.ExPASy.Enzyme.Record` class. This record derives from a Python dictionary and has keys corresponding to the two-letter codes used in Enzyme files. To read an Enzyme file containing one Enzyme record, use the `read` function in `Bio.ExPASy.Enzyme`:

```

>>> from Bio.ExPASy import Enzyme
>>> handle = open("lipoprotein.txt")
>>> record = Enzyme.read(handle)
>>> record["ID"]
'3.1.1.34'
>>> record["DE"]
'Lipoprotein lipase.'
>>> record["AN"]
['Clearing factor lipase.', 'Diacylglycerol lipase.', 'Diglyceride lipase.']
>>> record["CA"]
'Triacylglycerol + H(2)O = diacylglycerol + a carboxylate.'
>>> record["CC"]
['Hydrolyzes triacylglycerols in chylomicrons and very low-density lipoproteins (VLDL).', 'Also hydrolyzes diacylglycerol.']
>>> record["PR"]
['PDOC00110']
>>> record["DR"]
[['P11151', 'LIPL_BOVIN'], ['P11153', 'LIPL_CAVPO'], ['P11602', 'LIPL_CHICK'],
 ['P55031', 'LIPL_FELCA'], ['P06858', 'LIPL_HUMAN'], ['P11152', 'LIPL_MOUSE'],
 ['046647', 'LIPL_MUSVI'], ['P49060', 'LIPL_PAPAN'], ['P49923', 'LIPL_PIG'],
 ['Q06000', 'LIPL_RAT'], ['Q29524', 'LIPL_SHEEP']]

```

The `read` function raises a `ValueError` if no Enzyme record is found, and also if more than one Enzyme record is found.

The full set of Enzyme records can be downloaded as a single file (`enzyme.dat`) from the [ExPASy FTP site](#), containing 4877 records (release of 3 March 2009). To parse such a file containing multiple Enzyme records, use the `parse` function in `Bio.ExPASy.Enzyme` to obtain an iterator:

```

>>> from Bio.ExPASy import Enzyme
>>> handle = open("enzyme.dat")
>>> records = Enzyme.parse(handle)

```

We can now iterate over the records one at a time. For example, we can make a list of all EC numbers for which an Enzyme record is available:

```

>>> ecnumbers = [record["ID"] for record in records]

```

9.5 Accessing the ExPASy server

Swiss-Prot, Prosite, and Prosite documentation records can be downloaded from the ExPASy web server at <http://www.expasy.org>. Six kinds of queries are available from ExPASy:

get_prodoc_entry To download a Prosite documentation record in HTML format

get_prosite_entry To download a Prosite record in HTML format

get_prosite_raw To download a Prosite or Prosite documentation record in raw format

get_sprot_raw To download a Swiss-Prot record in raw format

sprot_search_ful To search for a Swiss-Prot record

sprot_search_de To search for a Swiss-Prot record

To access this web server from a Python script, we use the `Bio.ExPASy` module.

9.5.1 Retrieving a Swiss-Prot record

Let's say we are looking at chalcone synthases for Orchids (see section 2.3 for some justification for looking for interesting things about orchids). Chalcone synthase is involved in flavanoid biosynthesis in plants, and flavanoids make lots of cool things like pigment colors and UV protectants.

If you do a search on Swiss-Prot, you can find three orchid proteins for Chalcone Synthase, id numbers O23729, O23730, O23731. Now, let's write a script which grabs these, and parses out some interesting information.

First, we grab the records, using the `get_sprot_raw()` function of `Bio.ExPASy`. This function is very nice since you can feed it an id and get back a handle to a raw text record (no html to mess with!). We can use `Bio.SwissProt.read` to pull out the Swiss-Prot record, or `Bio.SeqIO.read` to get a `SeqRecord`. The following code accomplishes what I just wrote:

```
>>> from Bio import ExPASy
>>> from Bio import SwissProt

>>> accessions = ["O23729", "O23730", "O23731"]
>>> records = []

>>> for accession in accessions:
...     handle = ExPASy.get_sprot_raw(accession)
...     record = SwissProt.read(handle)
...     records.append(record)
```

If the accession number you provided to `ExPASy.get_sprot_raw` does not exist, then `SwissProt.read(handle)` will raise a `ValueError`. You can catch `ValueException` exceptions to detect invalid accession numbers:

```
>>> for accession in accessions:
...     handle = ExPASy.get_sprot_raw(accession)
...     try:
...         record = SwissProt.read(handle)
...     except ValueError:
...         print "WARNING: Accession %s not found" % accession
...     records.append(record)
```

9.5.2 Searching Swiss-Prot

Now, you may remark that I knew the records' accession numbers beforehand. Indeed, `get_sprot_raw()` needs either the entry name or an accession number. When you don't have them handy, you can use one of the `sprot_search_de()` or `sprot_search_ful()` functions.

`sprot_search_de()` searches in the ID, DE, GN, OS and OG lines; `sprot_search_ful()` searches in (nearly) all the fields. They are detailed on <http://www.expasy.org/cgi-bin/sprot-search-de> and <http://www.expasy.org/cgi-bin/sprot-search-ful> respectively. Note that they don't search in TrEMBL by default (argument `trembl`). Note also that they return html pages; however, accession numbers are quite easily extractable:

```
>>> from Bio import ExpPASy
>>> import re

>>> handle = ExpPASy.sprot_search_de("Orchid Chalcone Synthase")
>>> # or:
>>> # handle = ExpPASy.sprot_search_ful("Orchid and {Chalcone Synthase}")
>>> html_results = handle.read()
>>> if "Number of sequences found" in html_results:
...     ids = re.findall(r'HREF="/uniprot/(\w+)"', html_results)
... else:
...     ids = re.findall(r'href="/cgi-bin/niceprot\.pl\?(\w+)"', html_results)
```

9.5.3 Retrieving Prosite and Prosite documentation records

Prosite and Prosite documentation records can be retrieved either in HTML format, or in raw format. To parse Prosite and Prosite documentation records with Biopython, you should retrieve the records in raw format. For other purposes, however, you may be interested in these records in HTML format.

To retrieve a Prosite or Prosite documentation record in raw format, use `get_prosite_raw()`. For example, to download a Prosite record and print it out in raw text format, use

```
>>> from Bio import ExpPASy
>>> handle = ExpPASy.get_prosite_raw('PS00001')
>>> text = handle.read()
>>> print text
```

To retrieve a Prosite record and parse it into a `Bio.Prosite.Record` object, use

```
>>> from Bio import ExpPASy
>>> from Bio import Prosite
>>> handle = ExpPASy.get_prosite_raw('PS00001')
>>> record = Prosite.read(handle)
```

The same function can be used to retrieve a Prosite documentation record and parse it into a `Bio.ExpPASy.Prodoc.Record` object:

```
>>> from Bio import ExpPASy
>>> from Bio.ExpPASy import Prodoc
>>> handle = ExpPASy.get_prosite_raw('PDOC00001')
>>> record = Prodoc.read(handle)
```

For non-existing accession numbers, `ExpPASy.get_prosite_raw` returns a handle to an empty string. When faced with an empty string, `Prosite.read` and `Prodoc.read` will raise a `ValueError`. You can catch these exceptions to detect invalid accession numbers.

The functions `get_prosite_entry()` and `get_prodoc_entry()` are used to download Prosite and Prosite documentation records in HTML format. To create a web page showing one Prosite record, you can use

```
>>> from Bio import ExPASy
>>> handle = ExPASy.get_prosite_entry('PS00001')
>>> html = handle.read()
>>> output = open("myprositerecord.html", "w")
>>> output.write(html)
>>> output.close()
```

and similarly for a Prosite documentation record:

```
>>> from Bio import ExPASy
>>> handle = ExPASy.get_prodoc_entry('PDOC00001')
>>> html = handle.read()
>>> output = open("myprodocrecord.html", "w")
>>> output.write(html)
>>> output.close()
```

For these functions, an invalid accession number returns an error message in HTML format.

9.6 Scanning the Prosite database

[ScanProsite](#) allows you to scan protein sequences online against the Prosite database by providing a UniProt or PDB sequence identifier or the sequence itself. For more information about ScanProsite, please see the [ScanProsite documentation](#) as well as the [documentation for programmatic access of ScanProsite](#).

You can use Biopython's `Bio.ExPASy.ScanProsite` module to scan the Prosite database from Python. This module both helps you to access ScanProsite programmatically, and to parse the results returned by ScanProsite. To scan for Prosite patterns in the following protein sequence:

```
MEHKEVLLLLLLFLKSGQGEPLDDYVNTQGASLFSVTKKQLGAGSIEECAAKCEEDEEFT
CRAFQYHSKEQQCVIMAENRKSSIIIRMRDVVLFKVKVYLSECKTGNGKNYRGTMSKTKN
```

you can use the following code:

```
>>> sequence = "MEHKEVLLLLLLFLKSGQGEPLDDYVNTQGASLFSVTKKQLGAGSIEECAAKCEEDEEFT
CRAFQYHSKEQQCVIMAENRKSSIIIRMRDVVLFKVKVYLSECKTGNGKNYRGTMSKTKN"
>>> from Bio.ExPASy import ScanProsite
>>> handle = ScanProsite.scan(seq=sequence)
```

By executing `handle.read()`, you can obtain the search results in raw XML format. Instead, let's use `Bio.ExPASy.ScanProsite.read` to parse the raw XML into a Python object:

```
>>> result = ScanProsite.read(handle)
>>> type(result)
<class 'Bio.ExPASy.ScanProsite.Record'>
```

A `Bio.ExPASy.ScanProsite.Record` object is derived from a list, with each element in the list storing one ScanProsite hit. This object also stores the number of hits, as well as the number of search sequences, as returned by ScanProsite. This ScanProsite search resulted in six hits:

```
>>> result.n_seq
1
>>> result.n_match
6
>>> len(result)
```

6

```
>>> result[0]
{'signature_ac': u'PS50948', 'level': u'0', 'stop': 98, 'sequence_ac': u'USERSEQ1', 'start': 16, 'score
>>> result[1]
{'start': 37, 'stop': 39, 'sequence_ac': u'USERSEQ1', 'signature_ac': u'PS00005'}
>>> result[2]
{'start': 45, 'stop': 48, 'sequence_ac': u'USERSEQ1', 'signature_ac': u'PS00006'}
>>> result[3]
{'start': 60, 'stop': 62, 'sequence_ac': u'USERSEQ1', 'signature_ac': u'PS00005'}
>>> result[4]
{'start': 80, 'stop': 83, 'sequence_ac': u'USERSEQ1', 'signature_ac': u'PS00004'}
>>> result[5]
{'start': 106, 'stop': 111, 'sequence_ac': u'USERSEQ1', 'signature_ac': u'PS00008'}
```

Other ScanProsite parameters can be passed as keyword arguments; see the [documentation for programmatic access of ScanProsite](#) for more information. As an example, passing `lowscore=1` to include matches with low level scores lets use find one additional hit:

```
>>> handle = ScanProsite.scan(seq=sequence, lowscore=1)
>>> result = ScanProsite.read(handle)
>>> result.n_match
7
```

Chapter 10

Going 3D: The PDB module

Biopython also allows you to explore the extensive realm of macromolecular structure. Biopython comes with a PDBParser class that produces a Structure object. The Structure object can be used to access the atomic data in the file in a convenient manner.

10.1 Structure representation

A macromolecular structure is represented using a structure, model chain, residue, atom (or SMCRA) hierarchy. Figure 10.1 shows a UML class diagram of the SMCRA data structure. Such a data structure is not necessarily best suited for the representation of the macromolecular content of a structure, but it is absolutely necessary for a good interpretation of the data present in a file that describes the structure (typically a PDB or MMCIF file). If this hierarchy cannot represent the contents of a structure file, it is fairly certain that the file contains an error or at least does not describe the structure unambiguously. If a SMCRA data structure cannot be generated, there is reason to suspect a problem. Parsing a PDB file can thus be used to detect likely problems. We will give several examples of this in section 10.5.1.

Structure, Model, Chain and Residue are all subclasses of the Entity base class. The Atom class only (partly) implements the Entity interface (because an Atom does not have children).

For each Entity subclass, you can extract a child by using a unique id for that child as a key (e.g. you can extract an Atom object from a Residue object by using an atom name string as a key, you can extract a Chain object from a Model object by using its chain identifier as a key).

Disordered atoms and residues are represented by DisorderedAtom and DisorderedResidue classes, which are both subclasses of the DisorderedEntityWrapper base class. They hide the complexity associated with disorder and behave exactly as Atom and Residue objects.

In general, a child Entity object (i.e. Atom, Residue, Chain, Model) can be extracted from its parent (i.e. Residue, Chain, Model, Structure, respectively) by using an id as a key.

```
child_entity=parent_entity[child_id]
```

You can also get a list of all child Entities of a parent Entity object. Note that this list is sorted in a specific way (e.g. according to chain identifier for Chain objects in a Model object).

```
child_list=parent_entity.get_list()
```

You can also get the parent from a child.

```
parent_entity=child_entity.get_parent()
```

At all levels of the SMCRA hierarchy, you can also extract a *full id*. The full id is a tuple containing all id's starting from the top object (Structure) down to the current object. A full id for a Residue object e.g. is something like:

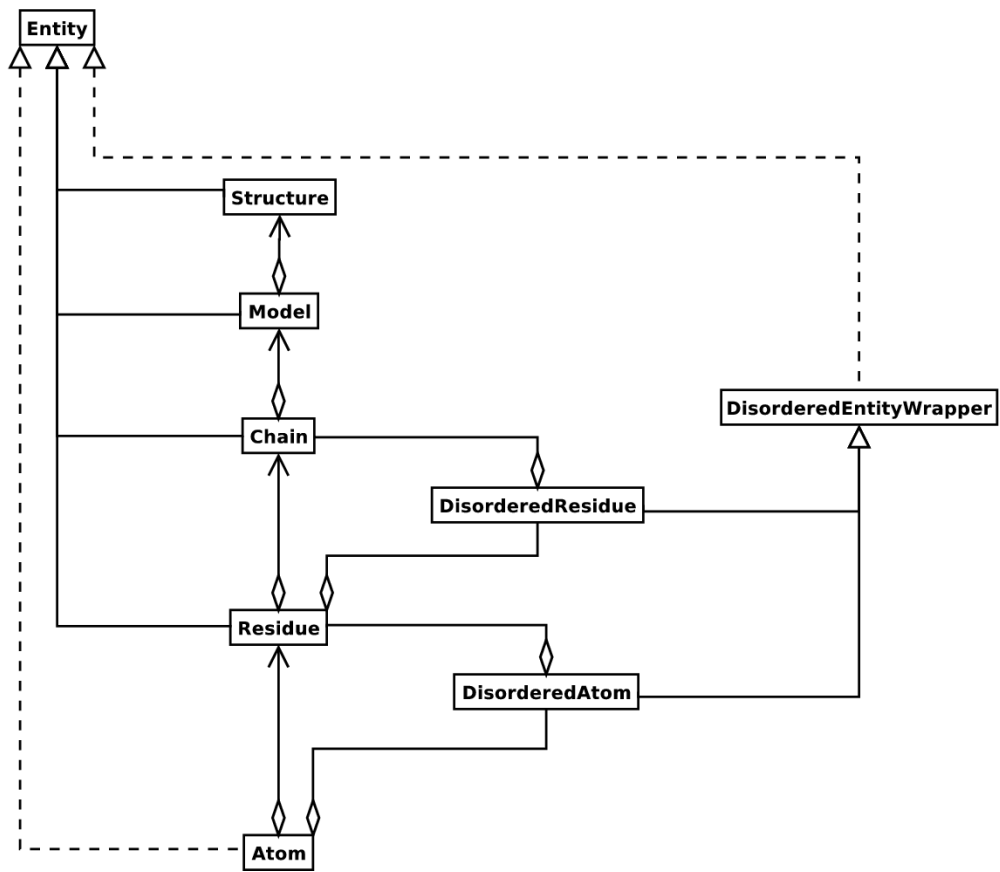

Figure 10.1: UML diagram of the SMCRA data structure used to represent a macromolecular structure.

```

full_id=residue.get_full_id()

print full_id

("1abc", 0, "A", ("", 10, "A"))

```

This corresponds to:

- The Structure with id "1abc"
- The Model with id 0
- The Chain with id "A"
- The Residue with id ("", 10, "A").

The Residue id indicates that the residue is not a hetero-residue (nor a water) because it has a blank hetero field, that its sequence identifier is 10 and that its insertion code is "A".

Some other useful methods:

```

# get the entity's id

entity.get_id()

# check if there is a child with a given id

entity.has_id(entity_id)

# get number of children

nr_children=len(entity)

```

It is possible to delete, rename, add, etc. child entities from a parent entity, but this does not include any sanity checks (e.g. it is possible to add two residues with the same id to one chain). This really should be done via a nice Decorator class that includes integrity checking, but you can take a look at the code (Entity.py) if you want to use the raw interface.

10.1.1 Structure

The Structure object is at the top of the hierarchy. Its id is a user given string. The Structure contains a number of Model children. Most crystal structures (but not all) contain a single model, while NMR structures typically consist of several models. Disorder in crystal structures of large parts of molecules can also result in several models.

10.1.1.1 Constructing a Structure object

A Structure object is produced by a PDBParser object:

```

from Bio.PDB.PDBParser import PDBParser

p=PDBParser(PERMISSIVE=1)

structure_id="1fat"

```

```
filename="pdb1fat.ent"
```

```
s=p.get_structure(structure_id, filename)
```

The `PERMISSIVE` flag indicates that a number of common problems (see [10.5.1](#)) associated with PDB files will be ignored (but note that some atoms and/or residues will be missing). If the flag is not present a `PDBConstructionException` will be generated during the parse operation.

10.1.1.2 Header and trailer

You can extract the header and trailer (simple lists of strings) of the PDB file from the `PDBParser` object with the `get_header` and `get_trailer` methods.

10.1.2 Model

The id of the `Model` object is an integer, which is derived from the position of the model in the parsed file (they are automatically numbered starting from 0). The `Model` object stores a list of `Chain` children.

10.1.2.1 Example

Get the first model from a `Structure` object.

```
first_model=structure[0]
```

10.1.3 Chain

The id of a `Chain` object is derived from the chain identifier in the structure file, and can be any string. Each `Chain` in a `Model` object has a unique id. The `Chain` object stores a list of `Residue` children.

10.1.3.1 Example

Get the `Chain` object with identifier “A” from a `Model` object.

```
chain_A=model["A"]
```

10.1.4 Residue

Unsurprisingly, a `Residue` object stores a set of `Atom` children. In addition, it also contains a string that specifies the residue name (e.g. “ASN”) and the segment identifier of the residue (well known to X-PLOR users, but not used in the construction of the SMCRA data structure).

The id of a `Residue` object is composed of three parts: the hetero field (`hetfield`), the sequence identifier (`resseq`) and the insertion code (`icode`).

The hetero field is a string : it is “W” for waters, “H.” followed by the residue name (e.g. “H.FUC”) for other hetero residues and blank for standard amino and nucleic acids. This scheme is adopted for reasons described in section [10.3.1](#).

The second field in the `Residue` id is the sequence identifier, an integer describing the position of the residue in the chain.

The third field is a string, consisting of the insertion code. The insertion code is sometimes used to preserve a certain desirable residue numbering scheme. A Ser 80 insertion mutant (inserted e.g. between a Thr 80 and an Asn 81 residue) could e.g. have sequence identifiers and insertion codes as followed: Thr 80 A, Ser 80 B, Asn 81. In this way the residue numbering scheme stays in tune with that of the wild type structure.

Let’s give some examples. Asn 10 with a blank insertion code would have residue id (‘ ’ ’’, 10, ‘ ’ ’’). Water 10 would have residue id (‘ ‘W’’, 10, ‘ ‘ ‘ ‘). A glucose molecule (a hetero residue with

residue name GLC) with sequence identifier 10 would have residue id ('H_GLC', 10, ' '). In this way, the three residues (with the same insertion code and sequence identifier) can be part of the same chain because their residue id's are distinct.

In most cases, the hetflag and insertion code fields will be blank, e.g. (' ', 10, ' '). In these cases, the sequence identifier can be used as a shortcut for the full id:

```
# use full id

res10=chain(["", 10, ""])

# use shortcut

res10=chain[10]
```

Each Residue object in a Chain object should have a unique id. However, disordered residues are dealt with in a special way, as described in section 10.2.3.2.

A Residue object has a number of additional methods:

```
r.get_resname() # return residue name, e.g. "ASN"
r.get_segid() # return the SEGID, e.g. "CHN1"
```

10.1.5 Atom

The Atom object stores the data associated with an atom, and has no children. The id of an atom is its atom name (e.g. "OG" for the side chain oxygen of a Ser residue). An Atom id needs to be unique in a Residue. Again, an exception is made for disordered atoms, as described in section 10.2.2.

In a PDB file, an atom name consists of 4 chars, typically with leading and trailing spaces. Often these spaces can be removed for ease of use (e.g. an amino acid $C\alpha$ atom is labeled ".CA." in a PDB file, where the dots represent spaces). To generate an atom name (and thus an atom id) the spaces are removed, unless this would result in a name collision in a Residue (i.e. two Atom objects with the same atom name and id). In the latter case, the atom name including spaces is tried. This situation can e.g. happen when one residue contains atoms with names ".CA." and "CA.", although this is not very likely.

The atomic data stored includes the atom name, the atomic coordinates (including standard deviation if present), the B factor (including anisotropic B factors and standard deviation if present), the altloc specifier and the full atom name including spaces. Less used items like the atom element number or the atomic charge sometimes specified in a PDB file are not stored.

An Atom object has the following additional methods:

```
a.get_name() # atom name (spaces stripped, e.g. "CA")
a.get_id() # id (equals atom name)
a.get_coord() # atomic coordinates
a.get_bfactor() # B factor
a.get_occupancy() # occupancy
a.get_altloc() # alternative location specifier
a.get_sigatm() # std. dev. of atomic parameters
a.get_siguij() # std. dev. of anisotropic B factor
a.get_anisou() # anisotropic B factor
a.get_fullname() # atom name (with spaces, e.g. ".CA.")
```

To represent the atom coordinates, siguij, anisotropic B factor and sigatm Numpy arrays are used.

10.2 Disorder

10.2.1 General approach

Disorder should be dealt with from two points of view: the atom and the residue points of view. In general, we have tried to encapsulate all the complexity that arises from disorder. If you just want to loop over all C α atoms, you do not care that some residues have a disordered side chain. On the other hand it should also be possible to represent disorder completely in the data structure. Therefore, disordered atoms or residues are stored in special objects that behave as if there is no disorder. This is done by only representing a subset of the disordered atoms or residues. Which subset is picked (e.g. which of the two disordered OG side chain atom positions of a Ser residue is used) can be specified by the user.

10.2.2 Disordered atoms

Disordered atoms are represented by ordinary Atom objects, but all Atom objects that represent the same physical atom are stored in a DisorderedAtom object. Each Atom object in a DisorderedAtom object can be uniquely indexed using its altloc specifier. The DisorderedAtom object forwards all uncaught method calls to the selected Atom object, by default the one that represents the atom with with the highest occupancy. The user can of course change the selected Atom object, making use of its altloc specifier. In this way atom disorder is represented correctly without much additional complexity. In other words, if you are not interested in atom disorder, you will not be bothered by it.

Each disordered atom has a characteristic altloc identifier. You can specify that a DisorderedAtom object should behave like the Atom object associated with a specific altloc identifier:

```
atom.disordered\_select("A") # select altloc A atom

print atom.get_altloc()
"A"

atom.disordered_select("B")      # select altloc B atom
print atom.get_altloc()
"B"
```

10.2.3 Disordered residues

10.2.3.1 Common case

The most common case is a residue that contains one or more disordered atoms. This is evidently solved by using DisorderedAtom objects to represent the disordered atoms, and storing the DisorderedAtom object in a Residue object just like ordinary Atom objects. The DisorderedAtom will behave exactly like an ordinary atom (in fact the atom with the highest occupancy) by forwarding all uncaught method calls to one of the Atom objects (the selected Atom object) it contains.

10.2.3.2 Point mutations

A special case arises when disorder is due to a point mutation, i.e. when two or more point mutants of a polypeptide are present in the crystal. An example of this can be found in PDB structure 1EN2.

Since these residues belong to a different residue type (e.g. let's say Ser 60 and Cys 60) they should not be stored in a single Residue object as in the common case. In this case, each residue is represented by one Residue object, and both Residue objects are stored in a DisorderedResidue object.

The DisorderedResidue object forwards all uncaught methods to the selected Residue object (by default the last Residue object added), and thus behaves like an ordinary residue. Each Residue object in a DisorderedResidue object can be uniquely identified by its residue name. In the above example, residue Ser 60

would have id “SER” in the DisorderedResidue object, while residue Cys 60 would have id “CYS”. The user can select the active Residue object in a DisorderedResidue object via this id.

10.3 Hetero residues

10.3.1 Associated problems

A common problem with hetero residues is that several hetero and non-hetero residues present in the same chain share the same sequence identifier (and insertion code). Therefore, to generate a unique id for each hetero residue, waters and other hetero residues are treated in a different way.

Remember that Residue object have the tuple (hetfield, resseq, icode) as id. The hetfield is blank (“”) for amino and nucleic acids, and a string for waters and other hetero residues. The content of the hetfield is explained below.

10.3.2 Water residues

The hetfield string of a water residue consists of the letter “W”. So a typical residue id for a water is (“W”, 1, “”).

10.3.3 Other hetero residues

The hetfield string for other hetero residues starts with “H_” followed by the residue name. A glucose molecule e.g. with residue name “GLC” would have hetfield “H_GLC”. Its residue id could e.g. be (“H_GLC”, 1, “”).

10.4 Some random usage examples

Parse a PDB file, and extract some Model, Chain, Residue and Atom objects.

```
from Bio.PDB.PDBParser import PDBParser

parser=PDBParser()

structure=parser.get_structure("test", "1fat.pdb")
model=structure[0]
chain=model["A"]
residue=chain[1]
atom=residue["CA"]
```

Extract a hetero residue from a chain (e.g. a glucose (GLC) moiety with resseq 10).

```
residue_id=("H_GLC", 10, " ")
residue=chain[residue_id]
```

Print all hetero residues in chain.

```
for residue in chain.get_list():
    residue_id=residue.get_id()
    hetfield=residue_id[0]
    if hetfield[0]=="H":
        print residue_id
```

Print out the coordinates of all CA atoms in a structure with B factor greater than 50.

```
for model in structure.get_list():
    for chain in model.get_list():
        for residue in chain.get_list():
            if residue.has_id("CA"):
                ca=residue["CA"]
                if ca.get_bfactor(>50.0:
                    print ca.get_coord()
```

Print out all the residues that contain disordered atoms.

```
for model in structure.get_list():
    for chain in model.get_list():
        for residue in chain.get_list():
            if residue.is_disordered():
                resseq=residue.get_id()[1]
                resname=residue.get_resname()
                model_id=model.get_id()
                chain_id=chain.get_id()
                print model_id, chain_id, resname, resseq
```

Loop over all disordered atoms, and select all atoms with altloc A (if present). This will make sure that the SMCRA data structure will behave as if only the atoms with altloc A are present.

```
for model in structure.get_list():
    for chain in model.get_list():
        for residue in chain.get_list():
            if residue.is_disordered():
                for atom in residue.get_list():
                    if atom.is_disordered():
                        if atom.disordered_has_id("A"):
                            atom.disordered_select("A")
```

Suppose that a chain has a point mutation at position 10, consisting of a Ser and a Cys residue. Make sure that residue 10 of this chain behaves as the Cys residue.

```
residue=chain[10]
residue.disordered_select("CYS")
```

10.5 Common problems in PDB files

10.5.1 Examples

The PDBParser/Structure class was tested on about 800 structures (each belonging to a unique SCOP superfamily). This takes about 20 minutes, or on average 1.5 seconds per structure. Parsing the structure of the large ribosomal subunit (1FKK), which contains about 64000 atoms, takes 10 seconds on a 1000 MHz PC.

Three exceptions were generated in cases where an unambiguous data structure could not be built. In all three cases, the likely cause is an error in the PDB file that should be corrected. Generating an exception in these cases is much better than running the chance of incorrectly describing the structure in a data structure.

10.5.1.1 Duplicate residues

One structure contains two amino acid residues in one chain with the same sequence identifier (resseq 3) and icode. Upon inspection it was found that this chain contains the residues Thr A3, . . . , Gly A202, Leu A3, Glu A204. Clearly, Leu A3 should be Leu A203. A couple of similar situations exist for structure 1FFK (which e.g. contains Gly B64, Met B65, Glu B65, Thr B67, i.e. residue Glu B65 should be Glu B66).

10.5.1.2 Duplicate atoms

Structure 1EJG contains a Ser/Pro point mutation in chain A at position 22. In turn, Ser 22 contains some disordered atoms. As expected, all atoms belonging to Ser 22 have a non-blank altloc specifier (B or C). All atoms of Pro 22 have altloc A, except the N atom which has a blank altloc. This generates an exception, because all atoms belonging to two residues at a point mutation should have non-blank altloc. It turns out that this atom is probably shared by Ser and Pro 22, as Ser 22 misses the N atom. Again, this points to a problem in the file: the N atom should be present in both the Ser and the Pro residue, in both cases associated with a suitable altloc identifier.

10.5.2 Automatic correction

Some errors are quite common and can be easily corrected without much risk of making a wrong interpretation. These cases are listed below.

10.5.2.1 A blank altloc for a disordered atom

Normally each disordered atom should have a non-blank altloc identifier. However, there are many structures that do not follow this convention, and have a blank and a non-blank identifier for two disordered positions of the same atom. This is automatically interpreted in the right way.

10.5.2.2 Broken chains

Sometimes a structure contains a list of residues belonging to chain A, followed by residues belonging to chain B, and again followed by residues belonging to chain A, i.e. the chains are “broken”. This is correctly interpreted.

10.5.3 Fatal errors

Sometimes a PDB file cannot be unambiguously interpreted. Rather than guessing and risking a mistake, an exception is generated, and the user is expected to correct the PDB file. These cases are listed below.

10.5.3.1 Duplicate residues

All residues in a chain should have a unique id. This id is generated based on:

- The sequence identifier (resseq).
- The insertion code (icode).
- The hetfield string (“W” for waters and “H.” followed by the residue name for other hetero residues)
- The residue names of the residues in the case of point mutations (to store the Residue objects in a DisorderedResidue object).

If this does not lead to a unique id something is quite likely wrong, and an exception is generated.

10.5.3.2 Duplicate atoms

All atoms in a residue should have a unique id. This id is generated based on:

- The atom name (without spaces, or with spaces if a problem arises).
- The altloc specifier.

If this does not lead to a unique id something is quite likely wrong, and an exception is generated.

10.6 Other features

There are also some tools to analyze a crystal structure. Tools exist to superimpose two coordinate sets (SVDSuperimposer), to extract polypeptides from a structure (Polypeptide), to perform neighbor lookup (NeighborSearch) and to write out PDB files (PDBIO). The neighbor lookup is done using a KD tree module written in C++. It is very fast and also includes a fast method to find all point pairs within a certain distance of each other.

A Polypeptide object is simply a UserList of Residue objects. You can construct a list of Polypeptide objects from a Structure object as follows:

```
model_nr=1
polypeptide_list=build_peptides(structure, model_nr)

for polypeptide in polypeptide_list:
    print polypeptide
```

The Polypeptide objects are always created from a single Model (in this case model 1).

Chapter 11

Bio.PopGen: Population genetics

Bio.PopGen is a new Biopython module supporting population genetics, available in Biopython 1.44 onwards.

The medium term objective for the module is to support widely used data formats, applications and databases. This module is currently under intense development and support for new features should appear at a rather fast pace. Unfortunately this might also entail some instability on the API, especially if you are using a development version. APIs that are made available on our official public releases should be much more stable.

11.1 GenePop

GenePop (<http://genepop.curtin.edu.au/>) is a popular population genetics software package supporting Hardy-Weinberg tests, linkage disequilibrium, population differentiation, basic statistics, F_{st} and migration estimates, among others. GenePop does not supply sequence based statistics as it doesn't handle sequence data. The GenePop file format is supported by a wide range of other population genetic software applications, thus making it a relevant format in the population genetics field.

Bio.PopGen provides a parser and generator of GenePop file format. Utilities to manipulate the content of a record are also provided. Here is an example on how to read a GenePop file (you can find example GenePop data files in the Test/PopGen directory of Biopython):

```
from Bio.PopGen import GenePop

handle = open("example.gen")
rec = GenePop.read(handle)
handle.close()
```

This will read a file called example.gen and parse it. If you do print rec, the record will be output again, in GenePop format.

The most important information in rec will be the loci names and population information (but there is more – use help(GenePop.Record) to check the API documentation). Loci names can be found on rec.loci_list. Population information can be found on rec.populations. Populations is a list with one element per population. Each element is itself a list of individuals, each individual is a pair composed by individual name and a list of alleles (2 per marker), here is an example for rec.populations:

```
[
  [
    ('Ind1', [(1, 2), (3, 3), (200, 201)]),
    ('Ind2', [(2, None), (3, 3), (None, None)]),
  ],
]
```

```
[
    ('Other1', [(1, 1), (4, 3), (200, 200)]),
]
```

So we have two populations, the first with two individuals, the second with only one. The first individual of the first population is called Ind1, allelic information for each of the 3 loci follows. Please note that for any locus, information might be missing (see as an example, Ind2 above).

A few utility functions to manipulate GenePop records are made available, here is an example:

```
from Bio.PopGen import GenePop

#Imagine that you have loaded rec, as per the code snippet above...

rec.remove_population(pos)
#Removes a population from a record, pos is the population position in
# rec.populations, remember that it starts on position 0.
# rec is altered.

rec.remove_locus_by_position(pos)
#Removes a locus by its position, pos is the locus position in
# rec.loci_list, remember that it starts on position 0.
# rec is altered.

rec.remove_locus_by_name(name)
#Removes a locus by its name, name is the locus name as in
# rec.loci_list. If the name doesn't exist the function fails
# silently.
# rec is altered.

rec_loci = rec.split_in_loci()
#Splits a record in loci, that is, for each loci, it creates a new
# record, with a single loci and all populations.
# The result is returned in a dictionary, being each key the locus name.
# The value is the GenePop record.
# rec is not altered.

rec_pops = rec.split_in_pops(pop_names)
#Splits a record in populations, that is, for each population, it creates
# a new record, with a single population and all loci.
# The result is returned in a dictionary, being each key
# the population name. As population names are not available in GenePop,
# they are passed in array (pop_names).
# The value of each dictionary entry is the GenePop record.
# rec is not altered.
```

GenePop does not support population names, a limitation which can be cumbersome at times. Functionality to enable population names is currently being planned for Biopython. These extensions won't break compatibility in any way with the standard format. In the medium term, we would also like to support the GenePop web service.

11.2 Coalescent simulation

A coalescent simulation is a backward model of population genetics with relation to time. A simulation of ancestry is done until the Most Recent Common Ancestor (MRCA) is found. This ancestry relationship starting on the MRCA and ending on the current generation sample is sometimes called a genealogy. Simple cases assume a population of constant size in time, haploidy, no population structure, and simulate the alleles of a single locus under no selection pressure.

Coalescent theory is used in many fields like selection detection, estimation of demographic parameters of real populations or disease gene mapping.

The strategy followed in the Biopython implementation of the coalescent was not to create a new, built-in, simulator from scratch but to use an existing one, SIMCOAL2 (<http://cmpg.unibe.ch/software/simcoal2/>). SIMCOAL2 allows for, among others, population structure, multiple demographic events, simulation of multiple types of loci (SNPs, sequences, STRs/microsatellites and RFLPs) with recombination, diploidy multiple chromosomes or ascertainment bias. Notably SIMCOAL2 doesn't support any selection model. We recommend reading SIMCOAL2's documentation, available in the link above.

The input for SIMCOAL2 is a file specifying the desired demography and genome, the output is a set of files (typically around 1000) with the simulated genomes of a sample of individuals per subpopulation. This set of files can be used in many ways, like to compute confidence intervals where which certain statistics (e.g., F_{st} or Tajima D) are expected to lie. Real population genetics datasets statistics can then be compared to those confidence intervals.

Biopython coalescent code allows to create demographic scenarios and genomes and to run SIMCOAL2.

11.2.1 Creating scenarios

Creating a scenario involves both creating a demography and a chromosome structure. In many cases (e.g. when doing Approximate Bayesian Computations – ABC) it is important to test many parameter variations (e.g. vary the effective population size, N_e , between 10, 50, 500 and 1000 individuals). The code provided allows for the simulation of scenarios with different demographic parameters very easily.

Below we see how we can create scenarios and then how simulate them.

11.2.1.1 Demography

A few predefined demographies are built-in, all have two shared parameters: sample size (called `sample_size` on the template, see below for its use) per deme and deme size, i.e. subpopulation size (`pop_size`). All demographies are available as templates where all parameters can be varied, each template has a system name. The predefined demographies/templates are:

Single population, constant size The standard parameters are enough to specify it. Template name: `simple`.

Single population, bottleneck As seen on figure 11.1. The parameters are current population size (`pop_size` on template `ne3` on figure), time of expansion, given as the generation in the past when it occurred (`expand_gen`), effective population size during bottleneck (`ne2`), time of contraction (`contract_gen`) and original size in the remote past (`ne3`). Template name: `bottle`.

Island model The typical island model. The total number of demes is specified by `total_demes` and the migration rate by `mig`. Template name `island`.

Stepping stone model - 1 dimension The stepping stone model in 1 dimension, extremes disconnected. The total number of demes is `total_demes`, migration rate is `mig`. Template name is `ssm_1d`.

Stepping stone model - 2 dimensions The stepping stone model in 2 dimensions, extremes disconnected. The parameters are `x` for the horizontal dimension and `y` for the vertical (being the total number of demes x times y), migration rate is `mig`. Template name is `ssm_2d`.

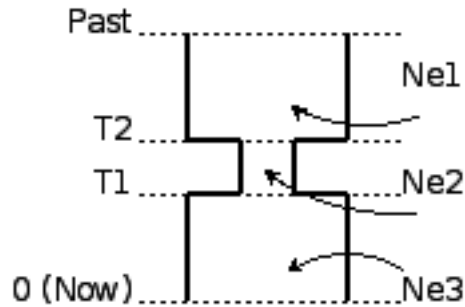

Figure 11.1: A bottleneck

In our first example, we will generate a template for a single population, constant size model with a sample size of 30 and a deme size of 500. The code for this is:

```
from Bio.PopGen.SimCoal.Template import generate_simcoal_from_template

generate_simcoal_from_template('simple',
    [(1, [('SNP', [24, 0.0005, 0.0])])],
    [('sample_size', [30]),
     ('pop_size', [100])])
```

Executing this code snippet will generate a file on the current directory called `simple_100.300.par` this file can be given as input to SIMCOAL2 to simulate the demography (below we will see how Biopython can take care of calling SIMCOAL2).

This code consists of a single function call, let's discuss it parameter by parameter.

The first parameter is the template id (from the list above). We are using the id 'simple' which is the template for a single population of constant size along time.

The second parameter is the chromosome structure. Please ignore it for now, it will be explained in the next section.

The third parameter is a list of all required parameters (recall that the simple model only needs `sample_size` and `pop_size`) and possible values (in this case each parameter only has a possible value).

Now, let's consider an example where we want to generate several island models, and we are interested in varying the number of demes: 10, 50 and 100 with a migration rate of 1%. Sample size and deme size will be the same as before. Here is the code:

```
from Bio.PopGen.SimCoal.Template import generate_simcoal_from_template

generate_simcoal_from_template('island',
    [(1, [('SNP', [24, 0.0005, 0.0])])],
    [('sample_size', [30]),
     ('pop_size', [100]),
     ('mig', [0.01]),
     ('total_demes', [10, 50, 100])])
```

In this case, 3 files will be generated: `island_100.0.01.100.30.par`, `island_10.0.01.100.30.par` and `island_50.0.01.100.30.par`. Notice the rule to make file names: template name, followed by parameter values in reverse order.

A few, arguably more esoteric template demographies exist (please check the `Bio/PopGen/SimCoal/data` directory on Biopython source tree). Furthermore it is possible for the user to create new templates. That functionality will be discussed in a future version of this document.

11.2.1.2 Chromosome structure

We strongly recommend reading SIMCOAL2 documentation to understand the full potential available in modeling chromosome structures. In this subsection we only discuss how to implement chromosome structures using the Biopython interface, not the underlying SIMCOAL2 capabilities.

We will start by implementing a single chromosome, with 24 SNPs with a recombination rate immediately on the right of each locus of 0.0005 and a minimum frequency of the minor allele of 0. This will be specified by the following list (to be passed as second parameter to the function `generate_simcoal_from_template`):

```
[(1, [('SNP', [24, 0.0005, 0.0]])]
```

This is actually the chromosome structure used in the above examples.

The chromosome structure is represented by a list of chromosomes, each chromosome (i.e., each element in the list) is composed by a tuple (a pair): the first element is the number of times the chromosome is to be repeated (as there might be interest in repeating the same chromosome many times). The second element is a list of the actual components of the chromosome. Each element is again a pair, the first member is the locus type and the second element the parameters for that locus type. Confused? Before showing more examples let's review the example above: We have a list with one element (thus one chromosome), the chromosome is a single instance (therefore not to be repeated), it is composed of 24 SNPs, with a recombination rate of 0.0005 between each consecutive SNP, the minimum frequency of the minor allele is 0.0 (i.e, it can be absent from a certain population).

Let's see a more complicated example:

```
[
  (5, [
    ('SNP', [24, 0.0005, 0.0])
  ]),
  (2, [
    ('DNA', [10, 0.0, 0.00005, 0.33]),
    ('RFLP', [1, 0.0, 0.0001]),
    ('MICROSAT', [1, 0.0, 0.001, 0.0, 0.0])
  ])
]
```

We start by having 5 chromosomes with the same structure as above (i.e., 24 SNPs). We then have 2 chromosomes which have a DNA sequence with 10 nucleotides, 0.0 recombination rate, 0.0005 mutation rate, and a transition rate of 0.33. Then we have an RFLP with 0.0 recombination rate to the next locus and a 0.0001 mutation rate. Finally we have a microsatellite (or STR), with 0.0 recombination rate to the next locus (note, that as this is a single microsatellite which has no loci following, this recombination rate here is irrelevant), with a mutation rate of 0.001, geometric parameter of 0.0 and a range constraint of 0.0 (for information about this parameters please consult the SIMCOAL2 documentation, you can use them to simulate various mutation models, including the typical – for microsatellites – stepwise mutation model among others).

11.2.2 Running SIMCOAL2

We now discuss how to run SIMCOAL2 from inside Biopython. It is required that the binary for SIMCOAL2 is called `simcoal2` (or `simcoal2.exe` on Windows based platforms), please note that the typical name when downloading the program is in the format `simcoal2_x.y`. As such, when installing SIMCOAL2 you will need to rename of the downloaded executable so that Biopython can find it.

It is possible to run SIMCOAL2 on files that were not generated using the method above (e.g., writing a parameter file by hand), but we will show an example by creating a model using the framework presented above.

```

from Bio.PopGen.SimCoal.Template import generate_simcoal_from_template
from Bio.PopGen.SimCoal.Controller import SimCoalController

generate_simcoal_from_template('simple',
    [
        (5, [
            ('SNP', [24, 0.0005, 0.0])
        ]),
        (2, [
            ('DNA', [10, 0.0, 0.00005, 0.33]),
            ('RFLP', [1, 0.0, 0.0001]),
            ('MICROSAT', [1, 0.0, 0.001, 0.0, 0.0])
        ])
    ],
    [('sample_size', [30]),
    ('pop_size', [100])])

ctrl = SimCoalController('.')
ctrl.run_simcoal('simple_100_30.par', 50)

```

The lines of interest are the last two (plus the new import). Firstly a controller for the application is created. The directory where the binary is located has to be specified.

The simulator is then run on the last line: we know, from the rules explained above, that the input file name is simple_100_30.par for the simulation parameter file created. We then specify that we want to run 50 independent simulations, by default Biopython requests a simulation of diploid data, but a third parameter can be added to simulate haploid data (adding as a parameter the string '0'). SIMCOAL2 will now run (please note that this can take quite a lot of time) and will create a directory with the simulation results. The results can now be analysed (typically studying the data with Arlequin3). In the future Biopython might support reading the Arlequin3 format and thus allowing for the analysis of SIMCOAL2 data inside Biopython.

11.3 Other applications

Here we discuss interfaces and utilities to deal with population genetics' applications which arguably have a smaller user base.

11.3.1 FDist: Detecting selection and molecular adaptation

FDist is a selection detection application suite based on computing (i.e. simulating) a “neutral” confidence interval based on F_{st} and heterozygosity. Markers (which can be SNPs, microsatellites, AFLPs among others) which lie outside the “neutral” interval are to be considered as possible candidates for being under selection.

FDist is mainly used when the number of markers is considered enough to estimate an average F_{st} , but not enough to either have outliers calculated from the dataset directly or, with even more markers for

which the relative positions in the genome are known, to use approaches based on, e.g., Extended Haplotype Heterozygosity (EHH).

The typical usage pattern for FDist is as follows:

1. Import a dataset from an external format into FDist format.
2. Compute average F_{st} . This is done by `datacal` inside FDist.
3. Simulate “neutral” markers based on the average F_{st} and expected number of total populations. This is the core operation, done by `fdist` inside FDist.
4. Calculate the confidence interval, based on the desired confidence boundaries (typically 95% or 99%). This is done by `cplot` and is mainly used to plot the interval.
5. Assess each marker status against the simulation “neutral” confidence interval. Done by `pv`. This is used to detect the outlier status of each marker against the simulation.

We will now discuss each step with illustrating example code (for this example to work FDist binaries have to be on the executable PATH).

The FDist data format is application specific and is not used at all by other applications, as such you will probably have to convert your data for use with FDist. Biopython can help you do this. Here is an example converting from GenePop format to FDist format (along with imports that will be needed on examples further below):

```
from Bio.PopGen import GenePop
from Bio.PopGen import FDist
from Bio.PopGen.FDist import Controller
from Bio.PopGen.FDist.Utils import convert_genepop_to_fdist

gp_rec = GenePop.read(open("example.gen"))
fd_rec = convert_genepop_to_fdist(gp_rec)
in_file = open("infile", "w")
in_file.write(str(fd_rec))
in_file.close()
```

In this code we simply parse a GenePop file and convert it to a FDist record.

Printing an FDist record will generate a string that can be directly saved to a file and supplied to FDist. FDist requires the input file to be called `infile`, therefore we save the record on a file with that name.

The most important fields on a FDist record are: `num_pops`, the number of populations; `num_loci`, the number of loci and `loci_data` with the marker data itself. Most probably the details of the record are of no interest to the user, as the record only purpose is to be passed to FDist.

The next step is to calculate the average F_{st} of the dataset (along with the sample size):

```
ctrl = Controller.FDistController()
fst, samp_size = ctrl.run_datacal()
```

On the first line we create an object to control the call of FDist suite, this object will be used further on in order to call other suite applications.

On the second line we call the `datacal` application which computes the average F_{st} and the sample size. It is worth noting that the F_{st} computed by `datacal` is a *variation* of Weir and Cockerham’s θ .

We can now call the main `fdist` application in order to simulate neutral markers.

```
sim_fst = ctrl.run_fdist(npops = 15, nsamples = fd_rec.num_pops, fst = fst,
                        sample_size = samp_size, mut = 0, num_sims = 40000)
```

npops Number of populations existing in nature. This is really a “guestimate”. Has to be lower than 100.

nsamples Number of populations sampled, has to be lower than npops.

fst Average F_{st} .

sample_size Average number of individuals sampled on each population.

mut Mutation model: 0 - Infinite alleles; 1 - Stepwise mutations

num_sims Number of simulations to perform. Typically a number around 40000 will be OK, but if you get a confidence interval that looks sharp (this can be detected when plotting the confidence interval computed below) the value can be increased (a suggestion would be steps of 10000 simulations).

The confusion in wording between number of samples and sample size stems from the original application.

A file named out.dat will be created with the simulated heterozygosities and F_{st} s, it will have as many lines as the number of simulations requested.

Note that fdist returns the average F_{st} that it was *capable* of simulating, for more details about this issue please read below the paragraph on approximating the desired average F_{st} .

The next (optional) step is to calculate the confidence interval:

```
cpl_interval = ctrl.run_cplot(ci=0.99)
```

You can only call cplot after having run fdist.

This will calculate the confidence intervals (99% in this case) for a previous fdist run. A list of quadruples is returned. The first element represents the heterozygosity, the second the lower bound of F_{st} confidence interval for that heterozygosity, the third the average and the fourth the upper bound. This can be used to trace the confidence interval contour. This list is also written to a file, out.cpl.

The main purpose of this step is return a set of points which can be easily used to plot a confidence interval. It can be skipped if the objective is only to assess the status of each marker against the simulation, which is the next step...

```
pv_data = ctrl.run_pv()
```

You can only call cplot after having run datacal and fdist.

This will use the simulated markers to assess the status of each individual real marker. A list, in the same order than the loci_list that is on the FDist record (which is in the same order that the GenePop record) is returned. Each element in the list is a quadruple, the fundamental member of each quadruple is the last element (regarding the other elements, please refer to the pv documentation – for the sake of simplicity we will not discuss them here) which returns the probability of the simulated F_{st} being lower than the marker F_{st} . Higher values would indicate a stronger candidate for positive selection, lower values a candidate for balancing selection, and intermediate values a possible neutral marker. What is “higher”, “lower” or “intermediate” is really a subjective issue, but taking a “confidence interval” approach and considering a 95% confidence interval, “higher” would be between 0.95 and 1.0, “lower” between 0.0 and 0.05 and “intermediate” between 0.05 and 0.95.

11.3.1.1 Approximating the desired average F_{st}

Fdist tries to approximate the desired average F_{st} by doing a coalescent simulation using migration rates based on the formula

$$N_m = \frac{1 - F_{st}}{4F_{st}}$$

This formula assumes a few premises like an infinite number of populations.

In practice, when the number of populations is low, the mutation model is stepwise and the sample size increases, `fdist` will not be able to simulate an acceptable approximate average F_{st} .

To address that, a function is provided to iteratively approach the desired value by running several `fdists` in sequence. This approach is computationally more intensive than running a single `fdist` run, but yields good results. The following code runs `fdist` approximating the desired F_{st} :

```
sim_fst = ctrl.run_fdist_force_fst(npops = 15, nsamples = fd_rec.num_pops,
    fst = fst, sample_size = samp_size, mut = 0, num_sims = 40000,
    limit = 0.05)
```

The only new optional parameter, when comparing with `run_fdist`, is `limit` which is the desired maximum error. `run_fdist` can (and probably should) be safely replaced with `run_fdist_force_fst`.

11.3.1.2 Final notes

The process to determine the average F_{st} can be more sophisticated than the one presented here. For more information we refer you to the `FDist` README file. `Biopython`'s code can be used to implement more sophisticated approaches.

11.4 Future Developments

The most desired future developments would be the ones you add yourself ;)

That being said, already existing fully functional code is currently being incorporated in `Bio.PopGen`, that code covers the applications `FDist` and `SimCoal2`, the `HapMap` and `UCSC Table Browser` databases and some simple statistics like F_{st} , or allele counts.

Chapter 12

Supervised learning methods

Note the supervised learning methods described in this chapter all require Numerical Python (numpy) to be installed.

12.1 The Logistic Regression Model

12.1.1 Background and Purpose

Logistic regression is a supervised learning approach that attempts to distinguish K classes from each other using a weighted sum of some predictor variables x_i . The logistic regression model is used to calculate the weights β_i of the predictor variables. In Biopython, the logistic regression model is currently implemented for two classes only ($K = 2$); the number of predictor variables has no predefined limit.

As an example, let's try to predict the operon structure in bacteria. An operon is a set of adjacent genes on the same strand of DNA that are transcribed into a single mRNA molecule. Translation of the single mRNA molecule then yields the individual proteins. For *Bacillus subtilis*, whose data we will be using, the average number of genes in an operon is about 2.4.

As a first step in understanding gene regulation in bacteria, we need to know the operon structure. For about 10% of the genes in *Bacillus subtilis*, the operon structure is known from experiments. A supervised learning method can be used to predict the operon structure for the remaining 90% of the genes.

For such a supervised learning approach, we need to choose some predictor variables x_i that can be measured easily and are somehow related to the operon structure. One predictor variable might be the distance in base pairs between genes. Adjacent genes belonging to the same operon tend to be separated by a relatively short distance, whereas adjacent genes in different operons tend to have a larger space between them to allow for promoter and terminator sequences. Another predictor variable is based on gene expression measurements. By definition, genes belonging to the same operon have equal gene expression profiles, while genes in different operons are expected to have different expression profiles. In practice, the measured expression profiles of genes in the same operon are not quite identical due to the presence of measurement errors. To assess the similarity in the gene expression profiles, we assume that the measurement errors follow a normal distribution and calculate the corresponding log-likelihood score.

We now have two predictor variables that we can use to predict if two adjacent genes on the same strand of DNA belong to the same operon:

- x_1 : the number of base pairs between them;
- x_2 : their similarity in expression profile.

In a logistic regression model, we use a weighted sum of these two predictors to calculate a joint score S :

$$S = \beta_0 + \beta_1 x_1 + \beta_2 x_2. \tag{12.1}$$

The logistic regression model gives us appropriate values for the parameters β_0 , β_1 , β_2 using two sets of example genes:

- OP: Adjacent genes, on the same strand of DNA, known to belong to the same operon;
- NOP: Adjacent genes, on the same strand of DNA, known to belong to different operons.

In the logistic regression model, the probability of belonging to a class depends on the score via the logistic function. For the two classes OP and NOP, we can write this as

$$\Pr(\text{OP}|x_1, x_2) = \frac{\exp(\beta_0 + \beta_1 x_1 + \beta_2 x_2)}{1 + \exp(\beta_0 + \beta_1 x_1 + \beta_2 x_2)} \quad (12.2)$$

$$\Pr(\text{NOP}|x_1, x_2) = \frac{1}{1 + \exp(\beta_0 + \beta_1 x_1 + \beta_2 x_2)} \quad (12.3)$$

Using a set of gene pairs for which it is known whether they belong to the same operon (class OP) or to different operons (class NOP), we can calculate the weights β_0 , β_1 , β_2 by maximizing the log-likelihood corresponding to the probability functions (12.2) and (12.3).

12.1.2 Training the logistic regression model

Table 12.1: Adjacent gene pairs known to belong to the same operon (class OP) or to different operons (class NOP). Intergene distances are negative if the two genes overlap.

| Gene pair | Intergene distance (x_1) | Gene expression score (x_2) | Class |
|-----------------------------|------------------------------|---------------------------------|-------|
| <i>cotJA</i> — <i>cotJB</i> | -53 | -200.78 | OP |
| <i>yesK</i> — <i>yesL</i> | 117 | -267.14 | OP |
| <i>lplA</i> — <i>lplB</i> | 57 | -163.47 | OP |
| <i>lplB</i> — <i>lplC</i> | 16 | -190.30 | OP |
| <i>lplC</i> — <i>lplD</i> | 11 | -220.94 | OP |
| <i>lplD</i> — <i>yetF</i> | 85 | -193.94 | OP |
| <i>yfmT</i> — <i>yfmS</i> | 16 | -182.71 | OP |
| <i>yfmF</i> — <i>yfmE</i> | 15 | -180.41 | OP |
| <i>citS</i> — <i>citT</i> | -26 | -181.73 | OP |
| <i>citM</i> — <i>yfiN</i> | 58 | -259.87 | OP |
| <i>yfiI</i> — <i>yfiJ</i> | 126 | -414.53 | NOP |
| <i>lipB</i> — <i>yfiQ</i> | 191 | -249.57 | NOP |
| <i>yfiU</i> — <i>yfiV</i> | 113 | -265.28 | NOP |
| <i>yfhH</i> — <i>yfhI</i> | 145 | -312.99 | NOP |
| <i>cotY</i> — <i>cotX</i> | 154 | -213.83 | NOP |
| <i>yjoB</i> — <i>rapA</i> | 147 | -380.85 | NOP |
| <i>ptsI</i> — <i>splA</i> | 93 | -291.13 | NOP |

Table 12.1 lists some of the *Bacillus subtilis* gene pairs for which the operon structure is known. Let's calculate the logistic regression model from these data:

```
>>> from Bio import LogisticRegression
>>> xs = [[-53, -200.78],
          [117, -267.14],
          [57, -163.47],
          [16, -190.30],
          [11, -220.94],
```



```
Iteration: 2 Log-likelihood function: -5.76877209868
Iteration: 3 Log-likelihood function: -5.11362294338
Iteration: 4 Log-likelihood function: -4.74870642433
Iteration: 5 Log-likelihood function: -4.50026077146
Iteration: 6 Log-likelihood function: -4.31127773737
Iteration: 7 Log-likelihood function: -4.16015043396
Iteration: 8 Log-likelihood function: -4.03561719785
Iteration: 9 Log-likelihood function: -3.93073282192
Iteration: 10 Log-likelihood function: -3.84087660929
Iteration: 11 Log-likelihood function: -3.76282560605
Iteration: 12 Log-likelihood function: -3.69425027154
Iteration: 13 Log-likelihood function: -3.6334178602
Iteration: 14 Log-likelihood function: -3.57900855837
Iteration: 15 Log-likelihood function: -3.52999671386
Iteration: 16 Log-likelihood function: -3.48557145163
Iteration: 17 Log-likelihood function: -3.44508206139
Iteration: 18 Log-likelihood function: -3.40799948447
Iteration: 19 Log-likelihood function: -3.3738885624
Iteration: 20 Log-likelihood function: -3.3423876581
Iteration: 21 Log-likelihood function: -3.31319343769
Iteration: 22 Log-likelihood function: -3.2860493346
Iteration: 23 Log-likelihood function: -3.2607366863
Iteration: 24 Log-likelihood function: -3.23706784091
Iteration: 25 Log-likelihood function: -3.21488073614
Iteration: 26 Log-likelihood function: -3.19403459259
Iteration: 27 Log-likelihood function: -3.17440646052
Iteration: 28 Log-likelihood function: -3.15588842703
Iteration: 29 Log-likelihood function: -3.13838533947
Iteration: 30 Log-likelihood function: -3.12181293595
Iteration: 31 Log-likelihood function: -3.10609629966
Iteration: 32 Log-likelihood function: -3.09116857282
Iteration: 33 Log-likelihood function: -3.07696988017
Iteration: 34 Log-likelihood function: -3.06344642288
Iteration: 35 Log-likelihood function: -3.05054971191
Iteration: 36 Log-likelihood function: -3.03823591619
Iteration: 37 Log-likelihood function: -3.02646530573
Iteration: 38 Log-likelihood function: -3.01520177394
Iteration: 39 Log-likelihood function: -3.00441242601
Iteration: 40 Log-likelihood function: -2.99406722296
Iteration: 41 Log-likelihood function: -2.98413867259
```

The iteration stops once the increase in the log-likelihood function is less than 0.01. If no convergence is reached after 500 iterations, the `train` function returns with an `AssertionError`.

The optional keyword `typecode` can almost always be ignored. This keyword allows the user to choose the type of Numeric matrix to use. In particular, to avoid memory problems for very large problems, it may be necessary to use single-precision floats (Float8, Float16, etc.) rather than double, which is used by default.

12.1.3 Using the logistic regression model for classification

Classification is performed by calling the `classify` function. Given a logistic regression model and the values for x_1 and x_2 (e.g. for a gene pair of unknown operon structure), the `classify` function returns 1 or

0, corresponding to class OP and class NOP, respectively. For example, let's consider the gene pairs *ycxE*, *ycxD* and *yxiB*, *yxiA*:

Table 12.2: Adjacent gene pairs of unknown operon status.

| Gene pair | Intergene distance x_1 | Gene expression score x_2 |
|---------------------------|--------------------------|-----------------------------|
| <i>ycxE</i> — <i>ycxD</i> | 6 | -173.143442352 |
| <i>yxiB</i> — <i>yxiA</i> | 309 | -271.005880394 |

The logistic regression model classifies *ycxE*, *ycxD* as belonging to the same operon (class OP), while *yxiB*, *yxiA* are predicted to belong to different operons:

```
>>> print "ycxE, yxcD:", LogisticRegression.classify(model, [6,-173.143442352])
ycxE, yxcD: 1
>>> print "yxiB, yxiA:", LogisticRegression.classify(model, [309, -271.005880394])
yxiB, yxiA: 0
```

(which, by the way, agrees with the biological literature).

To find out how confident we can be in these predictions, we can call the `calculate` function to obtain the probabilities (equations (12.2) and 12.3) for class OP and NOP. For *ycxE*, *ycxD* we find

```
>>> q, p = LogisticRegression.calculate(model, [6,-173.143442352])
>>> print "class OP: probability =", p, "class NOP: probability =", q
class OP: probability = 0.993242163503 class NOP: probability = 0.00675783649744
```

and for *yxiB*, *yxiA*

```
>>> q, p = LogisticRegression.calculate(model, [309, -271.005880394])
>>> print "class OP: probability =", p, "class NOP: probability =", q
class OP: probability = 0.000321211251817 class NOP: probability = 0.999678788748
```

To get some idea of the prediction accuracy of the logistic regression model, we can apply it to the training data:

```
>>> for i in range(len(ys)):
    print "True:", ys[i], "Predicted:", LogisticRegression.classify(model, xs[i])
True: 1 Predicted: 1
True: 1 Predicted: 0
True: 1 Predicted: 1
True: 1 Predicted: 1
True: 1 Predicted: 1
True: 1 Predicted: 1
True: 1 Predicted: 1
True: 1 Predicted: 1
True: 1 Predicted: 1
True: 1 Predicted: 1
True: 1 Predicted: 1
True: 1 Predicted: 1
True: 1 Predicted: 1
True: 0 Predicted: 0
True: 0 Predicted: 0
True: 0 Predicted: 0
True: 0 Predicted: 0
True: 0 Predicted: 0
True: 0 Predicted: 0
True: 0 Predicted: 0
True: 0 Predicted: 0
```

showing that the prediction is correct for all but one of the gene pairs. A more reliable estimate of the prediction accuracy can be found from a leave-one-out analysis, in which the model is recalculated from the training data after removing the gene to be predicted:

```
>>> for i in range(len(ys)):
    model = LogisticRegression.train(xs[:i]+xs[i+1:], ys[:i]+ys[i+1:])
    print "True:", ys[i], "Predicted:", LogisticRegression.classify(model, xs[i])
True: 1 Predicted: 1
True: 1 Predicted: 0
True: 1 Predicted: 1
True: 1 Predicted: 1
True: 1 Predicted: 1
True: 1 Predicted: 1
True: 1 Predicted: 1
True: 1 Predicted: 1
True: 1 Predicted: 1
True: 1 Predicted: 1
True: 0 Predicted: 0
True: 0 Predicted: 0
True: 0 Predicted: 0
True: 0 Predicted: 0
True: 0 Predicted: 1
True: 0 Predicted: 0
True: 0 Predicted: 0
```

The leave-one-out analysis shows that the prediction of the logistic regression model is incorrect for only two of the gene pairs, which corresponds to a prediction accuracy of 88%.

12.1.4 Logistic Regression, Linear Discriminant Analysis, and Support Vector Machines

The logistic regression model is similar to linear discriminant analysis. In linear discriminant analysis, the class probabilities also follow equations (12.2) and (12.3). However, instead of estimating the coefficients β directly, we first fit a normal distribution to the predictor variables x . The coefficients β are then calculated from the means and covariances of the normal distribution. If the distribution of x is indeed normal, then we expect linear discriminant analysis to perform better than the logistic regression model. The logistic regression model, on the other hand, is more robust to deviations from normality.

Another similar approach is a support vector machine with a linear kernel. Such an SVM also uses a linear combination of the predictors, but estimates the coefficients β from the predictor variables x near the boundary region between the classes. If the logistic regression model (equations (12.2) and (12.3)) is a good description for x away from the boundary region, we expect the logistic regression model to perform better than an SVM with a linear kernel, as it relies on more data. If not, an SVM with a linear kernel may perform better.

Trevor Hastie, Robert Tibshirani, and Jerome Friedman: *The Elements of Statistical Learning. Data Mining, Inference, and Prediction*. Springer Series in Statistics, 2001. Chapter 4.4.

12.2 k -Nearest Neighbors

12.2.1 Background and purpose

The k -nearest neighbors method is a supervised learning approach that does not need to fit a model to the data. Instead, data points are classified based on the categories of the k nearest neighbors in the training data set.

In Biopython, the k -nearest neighbors method is available in `Bio.kNN`. To illustrate the use of the k -nearest neighbor method in Biopython, we will use the same operon data set as in section 12.1.

12.2.2 Initializing a k -nearest neighbors model

Using the data in Table 12.1, we create and initialize a k -nearest neighbors model as follows:

```
>>> from Bio import kNN
>>> k = 3
>>> model = kNN.train(xs, ys, k)
```

where `xs` and `ys` are the same as in Section 12.1.2. Here, `k` is the number of neighbors k that will be considered for the classification. For classification into two classes, choosing an odd number for k lets you avoid tied votes. The function name `train` is a bit of a misnomer, since no model training is done: this function simply stores `xs`, `ys`, and `k` in `model`.

12.2.3 Using a k -nearest neighbors model for classification

To classify new data using the k -nearest neighbors model, we use the `classify` function. This function takes a data point (x_1, x_2) and finds the k -nearest neighbors in the training data set `xs`. The data point (x_1, x_2) is then classified based on which category (`ys`) occurs most among the k neighbors.

For the example of the gene pairs *ycxE*, *ycxD* and *yxiB*, *yxiA*, we find:

```
>>> x = [6, -173.143442352]
>>> print "ycxE, yxcD:", kNN.classify(model, x)
ycxE, yxcD: 1
>>> x = [309, -271.005880394]
>>> print "yxiB, yxiA:", kNN.classify(model, x)
yxiB, yxiA: 0
```

In agreement with the logistic regression model, *ycxE*, *ycxD* are classified as belonging to the same operon (class OP), while *yxiB*, *yxiA* are predicted to belong to different operons.

The `classify` function lets us specify both a distance function and a weight function as optional arguments. The distance function affects which k neighbors are chosen as the nearest neighbors, as these are defined as the neighbors with the smallest distance to the query point (x, y) . By default, the Euclidean distance is used. Instead, we could for example use the city-block (Manhattan) distance:

```
>>> def cityblock(x1, x2):
...     assert len(x1)==2
...     assert len(x2)==2
...     distance = abs(x1[0]-x2[0]) + abs(x1[1]-x2[1])
...     return distance
...
>>> x = [6, -173.143442352]
>>> print "ycxE, yxcD:", kNN.classify(model, x, distance_fn = cityblock)
ycxE, yxcD: 1
```

The weight function can be used for weighted voting. For example, we may want to give closer neighbors a higher weight than neighbors that are further away:

```
>>> def weight(x1, x2):
...     assert len(x1)==2
...     assert len(x2)==2
...     return exp(-abs(x1[0]-x2[0]) - abs(x1[1]-x2[1]))
```



```

...
>>> x = [6, -173.143442352]
>>> print "yxcE, yxcD:", kNN.classify(model, x, weight_fn = weight)
yxcE, yxcD: 1

```

By default, all neighbors are given an equal weight.

To find out how confident we can be in these predictions, we can call the `calculate` function, which will calculate the total weight assigned to the classes OP and NOP. For the default weighting scheme, this reduces to the number of neighbors in each category. For *yxcE*, *yxcD*, we find

```

>>> x = [6, -173.143442352]
>>> weight = kNN.calculate(model, x)
>>> print "class OP: weight =", weight[0], "class NOP: weight =", weight[1]
class OP: weight = 0.0 class NOP: weight = 3.0

```

which means that all three neighbors of *x1*, *x2* are in the NOP class. As another example, for *yesK*, *yesL* we find

```

>>> x = [117, -267.14]
>>> weight = kNN.calculate(model, x)
>>> print "class OP: weight =", weight[0], "class NOP: weight =", weight[1]
class OP: weight = 2.0 class NOP: weight = 1.0

```

which means that two neighbors are operon pairs and one neighbor is a non-operon pair.

To get some idea of the prediction accuracy of the *k*-nearest neighbors approach, we can apply it to the training data:

```

>>> for i in range(len(ys)):
    print "True:", ys[i], "Predicted:", kNN.classify(model, xs[i])
True: 1 Predicted: 1
True: 1 Predicted: 0
True: 1 Predicted: 1
True: 1 Predicted: 1
True: 1 Predicted: 1
True: 1 Predicted: 1
True: 1 Predicted: 1
True: 1 Predicted: 1
True: 1 Predicted: 1
True: 1 Predicted: 0
True: 0 Predicted: 0
True: 0 Predicted: 0
True: 0 Predicted: 0
True: 0 Predicted: 0
True: 0 Predicted: 0
True: 0 Predicted: 0
True: 0 Predicted: 0

```

showing that the prediction is correct for all but two of the gene pairs. A more reliable estimate of the prediction accuracy can be found from a leave-one-out analysis, in which the model is recalculated from the training data after removing the gene to be predicted:

```

>>> for i in range(len(ys)):
    model = kNN.train(xs[:i]+xs[i+1:], ys[:i]+ys[i+1:])
    print "True:", ys[i], "Predicted:", kNN.classify(model, xs[i])

```

True: 1 Predicted: 1
True: 1 Predicted: 0
True: 1 Predicted: 1
True: 1 Predicted: 1
True: 1 Predicted: 1
True: 1 Predicted: 1
True: 1 Predicted: 1
True: 1 Predicted: 1
True: 1 Predicted: 1
True: 1 Predicted: 1
True: 1 Predicted: 0
True: 0 Predicted: 0
True: 0 Predicted: 0
True: 0 Predicted: 1
True: 0 Predicted: 0
True: 0 Predicted: 0
True: 0 Predicted: 0
True: 0 Predicted: 0
True: 0 Predicted: 1

The leave-one-out analysis shows that k -nearest neighbors model is correct for 13 out of 17 gene pairs, which corresponds to a prediction accuracy of 76%.

12.3 Naïve Bayes

This section will describe the `Bio.NaiveBayes` module.

12.4 Maximum Entropy

This section will describe the `Bio.MaximumEntropy` module.

12.5 Markov Models

This section will describe the `Bio.MarkovModel` and/or `Bio.HMM.MarkovModel` modules.

Chapter 13

Graphics including GenomeDiagram

The `Bio.Graphics` module depends on the third party Python library [ReportLab](#). Although focused on producing PDF files, ReportLab can also create encapsulated postscript (EPS) and (SVG) files. In addition to these vector based images, provided certain further dependencies such as the [Python Imaging Library \(PIL\)](#) are installed, ReportLab can also output bitmap images (including JPEG, PNG, GIF, BMP and PICT formats).

13.1 GenomeDiagram

13.1.1 Introduction

The `Bio.Graphics.GenomeDiagram` module is a new addition to Biopython 1.50, having previously been available as a separate Python module dependent on Biopython. GenomeDiagram is described in the Bioinformatics journal publication Pritchard et al. (2006), [doi:10.1093/bioinformatics/btk021](https://doi.org/10.1093/bioinformatics/btk021), and there are several examples images and documentation for the old separate version available at <http://bioinf.scri.ac.uk/lp/programs.php#genomedialogram>.

As the name might suggest, GenomeDiagram was designed for drawing whole genomes, in particular prokaryotic genomes, either as linear diagrams (optionally broken up into fragments to fit better) or as circular wheel diagrams. It proves also well suited to drawing quite detailed figures for smaller genomes such as phage, plasmids or mitochondria.

This module is easiest to use if you have your genome loaded as a `SeqRecord` object containing lots of `SeqFeature` objects - for example as loaded from a GenBank file (see Chapters 4 and 5).

13.1.2 Diagrams, tracks, feature-sets and features

GenomeDiagram uses a nested set of objects. At the top level, you have a diagram object representing a sequence (or sequence region) along the horizontal axis (or circle). A diagram can contain one or more tracks, shown stacked vertically (or radially on circular diagrams). These will all have the same length and represent the same sequence region. You might use one track to show the gene locations, another to show regulatory regions, and a third track to show the GC percentage.

The most commonly used type of track will contain features, bundled together in feature-sets. You might choose to use one feature-set for all your CDS features, and another for tRNA features. This isn't required - they can all go in the same feature-set, but it makes it easier to update the properties of just selected features (e.g. make all the tRNA features red).

There are two main ways to build up a complete diagram. Firstly, the top down approach where you create a diagram object, and then using its methods add track(s), and use the track methods to add feature-set(s), and use their methods to add the features. Secondly, you can create the individual objects separately (in whatever order suits your code), and then combine them.

13.1.3 A top down example

We're going to draw a whole genome from a `SeqRecord` object read in from a GenBank file (see Chapter 5). This example uses the pPCP1 plasmid from *Yersinia pestis biovar Microtus*, the file is included with the Biopython unit tests under the GenBank folder, or online [NC_005816.gb](http://www.ncbi.nlm.nih.gov/GenBank/NC_005816.gb) from our website.

```
from reportlab.lib import colors
from reportlab.lib.units import cm
from Bio.Graphics import GenomeDiagram
from Bio import SeqIO
record = SeqIO.read("NC_005816.gb", "genbank")
```

We're using a top down approach, so after loading in our sequence we next create an empty diagram, then add an (empty) track, and to that add an (empty) feature set:

```
gd_diagram = GenomeDiagram.Diagram("Yersinia pestis biovar Microtus plasmid pPCP1")
gd_track_for_features = gd_diagram.new_track(1, name="Annotated Features")
gd_feature_set = gd_track_for_features.new_set()
```

Now the fun part - we take each gene `SeqFeature` object in our `SeqRecord`, and use it to generate a feature on the diagram. We're going to color them blue, alternating between a dark blue and a light blue.

```
for feature in record.features:
    if feature.type != "gene":
        #Exclude this feature
        continue
    if len(gd_feature_set) % 2 == 0:
        color = colors.blue
    else:
        color = colors.lightblue
    gd_feature_set.add_feature(feature, color=color, label=True)
```

Now we come to actually making the output file. This happens in two steps, first we call the `draw` method, which creates all the shapes using ReportLab objects. Then we call the `write` method which renders these to the requested file format. Note you can output in multiple file formats:

```
gd_diagram.draw(format="linear", orientation="landscape", pagesize='A4',
                fragments=4, start=0, end=len(record))
gd_diagram.write("plasmid_linear.pdf", "PDF")
gd_diagram.write("plasmid_linear.eps", "EPS")
gd_diagram.write("plasmid_linear.svg", "SVG")
```

Also, provided you have the dependencies installed, you can also do bitmaps, for example:

```
gd_diagram.write("plasmid_linear.png", "PNG")
```

The expected output is shown in Figure 13.1. Notice that the `fragments` argument which we set to four controls how many pieces the genome gets broken up into.

If you want to do a circular figure, then try this:

```
gd_diagram.move_track(1,3) # move track to make an empty space in the middle
gd_diagram.draw(format="circular", circular=True, pagesize=(20*cm,20*cm),
                start=0, end=len(record))
gd_diagram.write("plasmid_circular.pdf", "PDF")
```

The expected output is shown in Figure 13.2. These figures are not very exciting, but we've only just got started.

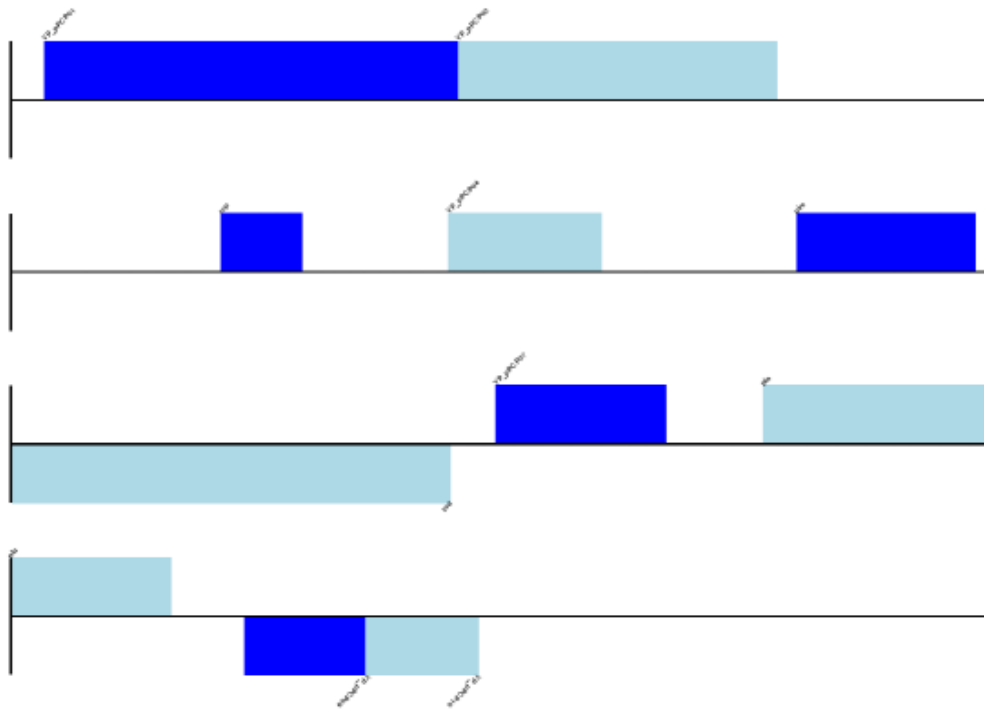

Figure 13.1: Simple linear diagram for *Yersinia pestis* biovar *Microtus* plasmid pPCP1.

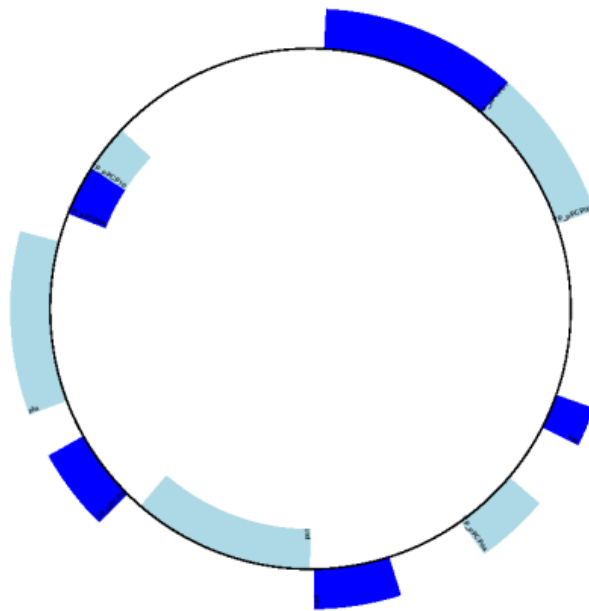

Figure 13.2: Simple circular diagram for *Yersinia pestis* biovar *Microtus* plasmid pPCP1.

13.1.4 A bottom up example

Now let's produce exactly the same figures, but using the bottom up approach. This means we create the different objects directly (and this can be done in almost any order) and then combine them.

```
from reportlab.lib import colors
from reportlab.lib.units import cm
from Bio.Graphics import GenomeDiagram
from Bio import SeqIO
record = SeqIO.read("NC_005816.gb", "genbank")

#Create the feature set and its feature objects,
gd_feature_set = GenomeDiagram.FeatureSet()
for feature in record.features:
    if feature.type != "gene":
        #Exclude this feature
        continue
    if len(gd_feature_set) % 2 == 0:
        color = colors.blue
    else:
        color = colors.lightblue
    gd_feature_set.add_feature(feature, color=color, label=True)
#(this for loop is the same as in the previous example)

#Create a track, and a diagram
gd_track_for_features = GenomeDiagram.Track(name="Annotated Features")
gd_diagram = GenomeDiagram.Diagram("Yersinia pestis biovar Microtus plasmid pPCP1")

#Now have to glue the bits together...
gd_track_for_features.add_set(gd_feature_set)
gd_diagram.add_track(gd_track_for_features, 1)
```

You can now call the `draw` and `write` methods as before to produce a linear or circular diagram, using the code at the end of the top-down example above. The figures should be identical.

13.1.5 Features without a SeqFeature

In the above example we used a `SeqRecord`'s `SeqFeature` objects to build our diagram (see also Section 4.3). Sometimes you won't have `SeqFeature` objects, but just the coordinates for a feature you want to draw. You have to create minimal `SeqFeature` object, but this is easy:

```
from Bio.SeqFeature import SeqFeature, FeatureLocation
my_seq_feature = SeqFeature(FeatureLocation(50,100),strand=+1)
```

For strand, use +1 for the forward strand, -1 for the reverse strand, and `None` for both. Here is a short self contained example:

```
from Bio.SeqFeature import SeqFeature, FeatureLocation
from Bio.Graphics import GenomeDiagram
from reportlab.lib.units import cm

gdd = GenomeDiagram.Diagram('Test Diagram')
gdt_features = gdd.new_track(1, greytrack=False)
```

```

gds_features = gdt_features.new_set()

#Add three features to show the strand options,
feature = SeqFeature(FeatureLocation(25, 125), strand=+1)
gds_features.add_feature(feature, name="Forward", label=True)
feature = SeqFeature(FeatureLocation(150, 250), strand=None)
gds_features.add_feature(feature, name="Standless", label=True)
feature = SeqFeature(FeatureLocation(275, 375), strand=-1)
gds_features.add_feature(feature, name="Reverse", label=True)

gdd.draw(format='linear', pagesize=(15*cm,4*cm), fragments=1,
         start=0, end=400)
gdd.write("GD_labels_default.pdf", "pdf")

```

The output is shown at the top of Figure 13.3 (in the default feature color, pale green).

Notice that we have used the `name` argument here to specify the caption text for these features. This is discussed in more detail next.

13.1.6 Feature captions

Recall we used the following (where `feature` was a `SeqFeature` object) to add a feature to the diagram:

```
gd_feature_set.add_feature(feature, color=color, label=True)
```

In the example above the `SeqFeature` annotation was used to pick a sensible caption for the features. By default the following possible entries under the `SeqFeature` object's qualifiers dictionary are used: `gene`, `label`, `name`, `locus_tag`, and `product`. More simply, you can specify a name directly:

```
gd_feature_set.add_feature(feature, color=color, label=True, name="My Gene")
```

In addition to the caption text for each feature's label, you can also choose the font, position (this defaults to the start of the sigil, you can also choose the middle or at the end) and orientation (for linear diagrams only, where this defaults to rotated by 45 degrees):

```

#Large font, parallel with the track
gd_feature_set.add_feature(feature, label=True, color="green",
                          label_size=25, label_angle=0)

#Very small font, perpendicular to the track (towards it)
gd_feature_set.add_feature(feature, label=True, color="purple",
                          label_position="end",
                          label_size=4, label_angle=90)

#Small font, perpendicular to the track (away from it)
gd_feature_set.add_feature(feature, label=True, color="blue",
                          label_position="middle",
                          label_size=6, label_angle=-90)

```

Combining each of these three fragments with the complete example in the previous section should give something like the tracks in Figure 13.3.

We've not shown it here, but you can also set `label_color` to control the label's color (used in Section 13.1.8).

You'll notice the default font is quite small - this makes sense because you will usually be drawing many (small) features on a page, not just a few large ones as shown here.

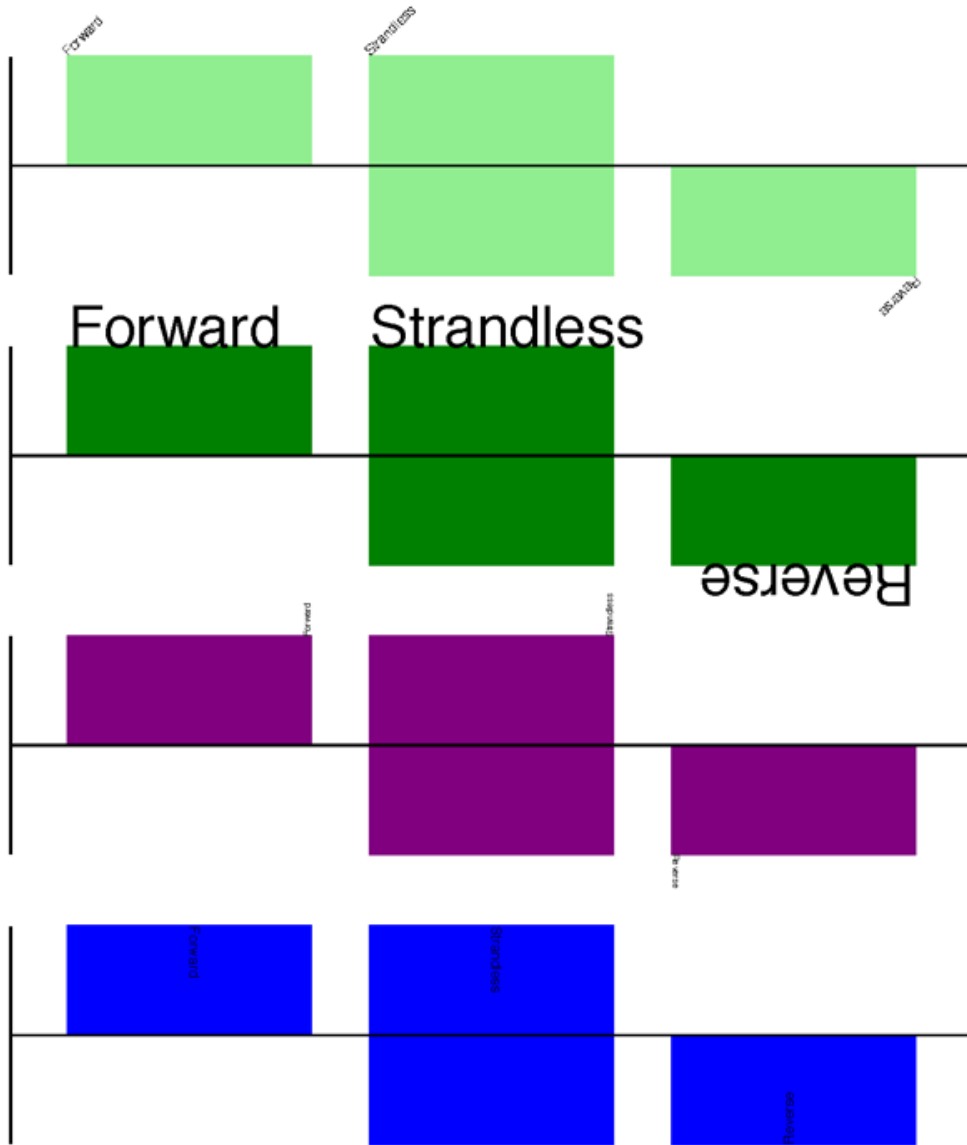

Figure 13.3: Simple GenomeDiagram showing label options. The top plot in pale green shows the default label settings (see Section 13.1.5) while the rest show variations in the label size, position and orientation (see Section 13.1.6).

13.1.7 Feature sigils

The examples above have all just used the default sigil for the feature, a plain box, but you can also use *arrows* instead. Note this wasn't available in the last publically released standalone version of GenomeDiagram.

```
#Default uses a BOX sigil
gd_feature_set.add_feature(feature)

#You can make this explicit:
gd_feature_set.add_feature(feature, sigil="BOX")

#Or opt for an arrow:
gd_feature_set.add_feature(feature, sigil="ARROW")
```

The default arrows are shown at the top of Figures 13.4 and 13.5. The arrows fit into a bounding box (as given by the default BOX sigil).

There are two additional options to adjust the shapes of the arrows, firstly the thickness of the arrow shaft, given as a proportion of the height of the bounding box:

```
#Full height shafts, giving pointed boxes:
gd_feature_set.add_feature(feature, sigil="ARROW", color="brown",
                           arrowshaft_height=1.0)

#Or, thin shafts:
gd_feature_set.add_feature(feature, sigil="ARROW", color="teal",
                           arrowshaft_height=0.2)

#Or, very thin shafts:
gd_feature_set.add_feature(feature, sigil="ARROW", color="darkgreen",
                           arrowshaft_height=0.1)
```

The results are shown in Figure 13.4.

Secondly, the length of the arrow head - given as a proportion of the height of the bounding box (defaulting to 0.5, or 50%):

```
#Short arrow heads:
gd_feature_set.add_feature(feature, sigil="ARROW", color="blue",
                           arrowhead_length=0.25)

#Or, longer arrow heads:
gd_feature_set.add_feature(feature, sigil="ARROW", color="orange",
                           arrowhead_length=1)

#Or, very very long arrow heads (i.e. all head, no shaft, so triangles):
gd_feature_set.add_feature(feature, sigil="ARROW", color="red",
                           arrowhead_length=10000)
```

The results are shown in Figure 13.5.

13.1.8 A nice example

Now let's return to the pPCP1 plasmid from *Yersinia pestis* biovar *Microtus*, and the top down approach used in Section 13.1.3, but take advantage of the sigil options we've now discussed. This time we'll use arrows for the genes, and overlay them with strandless features (as plain boxes) showing the position of some restriction digest sites.

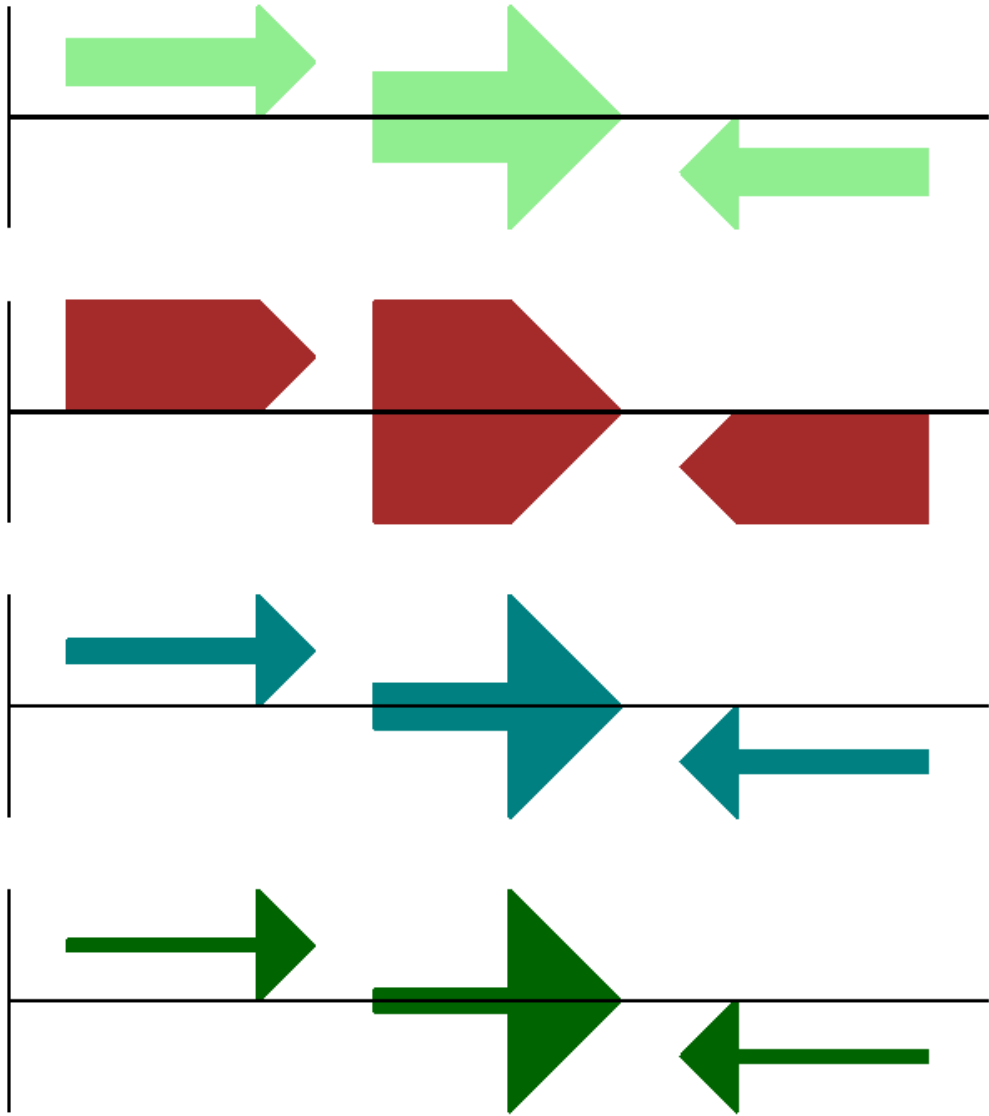

Figure 13.4: Simple GenomeDiagram showing arrow shaft options (see Section 13.1.7)

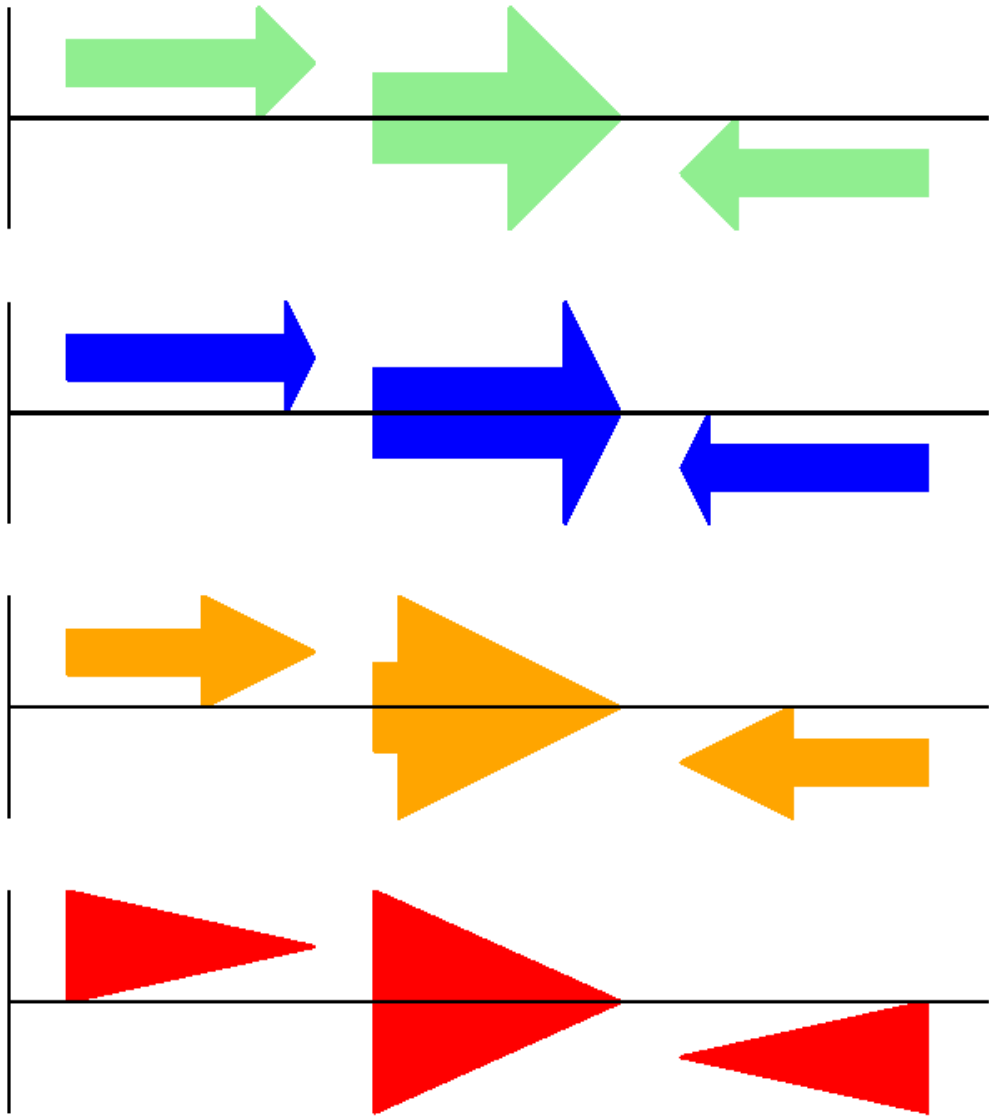

Figure 13.5: Simple GenomeDiagram showing arrow head options (see Section 13.1.7)

```

from reportlab.lib import colors
from Bio.Graphics import GenomeDiagram
from Bio import SeqIO
from Bio.SeqFeature import SeqFeature, FeatureLocation

record = SeqIO.read("NC_005816.gb", "genbank")

gd_diagram = GenomeDiagram.Diagram(record.id)
gd_track_for_features = gd_diagram.new_track(1, name="Annotated Features")
gd_feature_set = gd_track_for_features.new_set()

for feature in record.features:
    if feature.type != "gene":
        #Exclude this feature
        continue
    if len(gd_feature_set) % 2 == 0:
        color = colors.blue
    else:
        color = colors.lightblue
    gd_feature_set.add_feature(feature, sigil="ARROW",
                              color=color, label=True,
                              label_size = 14, label_angle=0)

#I want to include some strandless features, so for an example
#will use EcoRI recognition sites etc.
for site, name, color in [("GAATTC", "EcoRI", colors.green),
                          ("CCCGGG", "SmaI", colors.orange),
                          ("AAGCTT", "HindIII", colors.red),
                          ("GGATCC", "BamHI", colors.purple)]:
    index = 0
    while True:
        index = record.seq.find(site, start=index)
        if index == -1 : break
        feature = SeqFeature(FeatureLocation(index, index+len(site)))
        gd_feature_set.add_feature(feature, color=color, name=name,
                                  label=True, label_size = 10,
                                  label_color=color)

        index += len(site)

gd_diagram.draw(format="linear", pagesize='A4', fragments=4,
                start=0, end=len(record))
gd_diagram.write("plasmid_linear_nice.pdf", "PDF")
gd_diagram.write("plasmid_linear_nice.eps", "EPS")
gd_diagram.write("plasmid_linear_nice.svg", "SVG")

```

The expected output is shown in [Figure 13.6](#).

13.1.9 Further options

All the examples so far have used a single track, but you can have more than one track – for example show the genes on one, and repeat regions on another. You can also enable tick marks to show the scale – after all every graph should show its units.

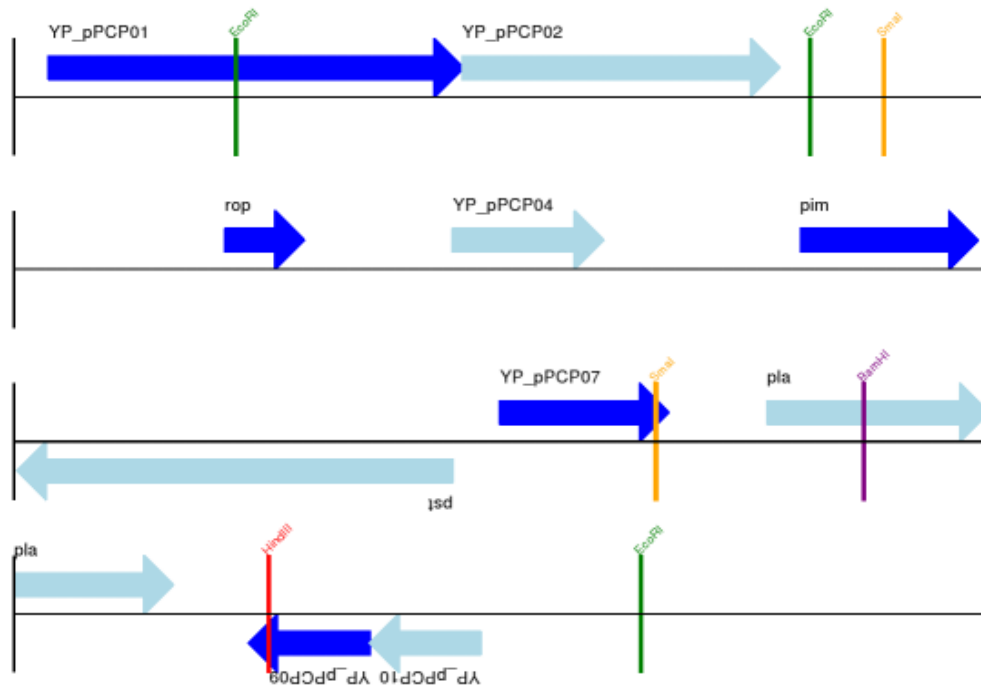

Figure 13.6: Linear diagram for *Yersinia pestis biovar Microtus* plasmid pPCP1 showing selected restriction digest sites (see Section 13.1.8).

Also, we have only used the `FeatureSet` so far. `GenomeDiagram` also has a `GraphSet` which can be used for show line graphs, bar charts and heat plots (e.g. to show plots of GC% on a track parallel to the features).

These options are not covered here yet, so for now we refer you to the [User Guide \(PDF\)](#) included with the standalone version of `GenomeDiagram` (but please read the next section first), and the docstrings.

13.1.10 Converting old code

If you have old code written using the standalone version of `GenomeDiagram`, and you want to switch it over to using the new version included with Biopython then you will have to make a few changes - most importantly to your import statements.

Also, the older version of `GenomeDiagram` used only the UK spellings of color and center (colour and centre). As part of the integration into Biopython, both forms can now be used for argument names. However, at some point in the future the UK spellings may be deprecated.

For example, if you used to have:

```
from GenomeDiagram import GDFeatureSet, GDDiagram
gdd = GDDiagram("An example")
...
```

you could just switch the import statements like this:

```
from Bio.Graphics.GenomeDiagram import FeatureSet as GDFeatureSet, Diagram as GDDiagram
gdd = GDDiagram("An example")
...
```

and hopefully that should be enough. In the long term you might want to switch to the new names, but you would have to change more of your code:

```
from Bio.Graphics.GenomeDiagram import FeatureSet, Diagram
gdd = Diagram("An example")
...
```

or:

```
from Bio.Graphics import GenomeDiagram
gdd = GenomeDiagram.Diagram("An example")
...
```

If you run into difficulties, please ask on the Biopython mailing list for advice. One catch is that for Biopython 1.50, we have not yet included the old module `GenomeDiagram.GDUtilities` yet. This included a number of GC% related functions, which will probably be merged under `Bio.SeqUtils` later on.

13.2 Chromosomes

The `Bio.Graphics.BasicChromosome` module allows drawing of simple chromosomes. Here is a very simple example - for which we'll use *Arabidopsis thaliana*.

I first downloaded the five sequenced chromosomes from the NCBI's FTP site ftp://ftp.ncbi.nlm.nih.gov/genomes/Arabidopsis_thaliana and then parsed them with `Bio.SeqIO` to find out their lengths. You could use the GenBank files for this, but it is faster to use the FASTA files for the whole chromosomes:

```
from Bio import SeqIO
entries = [("Chr I", "CHR_I/NC_003070.fna"),
          ("Chr II", "CHR_II/NC_003071.fna"),
          ("Chr III", "CHR_III/NC_003074.fna"),
          ("Chr IV", "CHR_IV/NC_003075.fna"),
          ("Chr V", "CHR_V/NC_003076.fna")]
for (name, filename) in entries:
    record = SeqIO.read(filename, "fasta")
    print name, len(record)
```

This gave the lengths of the five chromosomes, which we'll now use in the following short demonstration of the `BasicChromosome` module:

```
from Bio.Graphics import BasicChromosome

entries = [("Chr I", 30432563),
          ("Chr II", 19705359),
          ("Chr III", 23470805),
          ("Chr IV", 18585042),
          ("Chr V", 26992728)]

max_length = max([length for name, length in entries])

chr_diagram = BasicChromosome.Organism()
for name, length in entries:
    cur_chromosome = BasicChromosome.Chromosome(name)
    #Set the length, adding and extra 20 percent for the telomeres:
    cur_chromosome.scale_num = max_length * 1.2
```

```

#Add an opening telomere
start = BasicChromosome.TelomereSegment()
start.scale = 0.1 * max_length
cur_chromosome.add(start)

#Add a body - using bp as the scale length here.
body = BasicChromosome.ChromosomeSegment()
body.scale = length
cur_chromosome.add(body)

#Add a closing telomere
end = BasicChromosome.TelomereSegment(inverted=True)
end.scale = 0.1 * max_length
cur_chromosome.add(end)

#This chromosome is done
chr_diagram.add(cur_chromosome)

chr_diagram.draw("simple_chrom.pdf", "Arabidopsis thaliana")

```

This should create a very simple PDF file, shown in Figure 13.7. This example is deliberately short and sweet. One thing you might want to try is showing the location of features of interest - perhaps SNPs or genes. Currently the `ChromosomeSegment` object doesn't support sub-segments which would be one approach. Instead, you must replace the single large segment with lots of smaller segments, maybe white ones for the boring regions, and colored ones for the regions of interest.

Arabidopsis thaliana

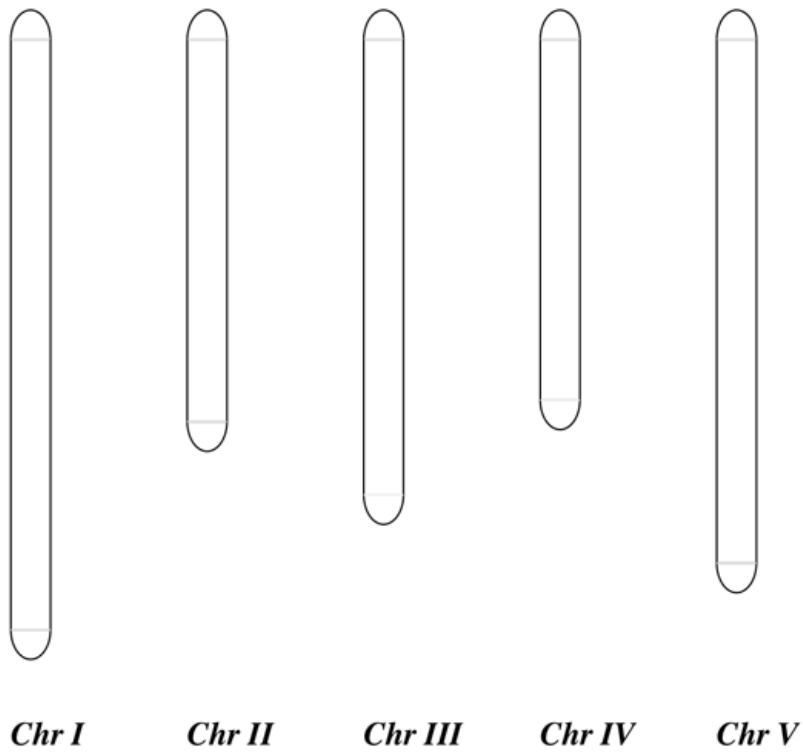

Figure 13.7: Simple chromosome diagram for *Arabidopsis thaliana*.

Chapter 14

Cookbook – Cool things to do with it

Biopython now has two collections of “cookbook” examples – this chapter (which has been included in this tutorial for many years and has gradually grown), and <http://biopython.org/wiki/Category:Cookbook> which is a user contributed collection on our wiki.

We’re trying to encourage Biopython users to contribute their own examples to the wiki. In addition to helping the community, one direct benefit of sharing an example like this is that you could also get some feedback on the code from other Biopython users and developers - which could help you improve all your Python code.

In the long term, we may end up moving all of the examples in this chapter to the wiki, or elsewhere within the tutorial.

14.1 Working with sequence files

This section shows some more examples of sequence input/output, using the `Bio.SeqIO` module described in Chapter 5.

14.1.1 Producing randomised genomes

Let’s suppose you are looking at genome sequence, hunting for some sequence feature – maybe extreme local GC% bias, or possible restriction digest sites. Once you’ve got your Python code working on the real genome it may be sensible to try running the same search on randomised versions of the same genome for statistical analysis (after all, any “features” you’ve found could just be there just by chance).

For this discussion, we’ll use the GenBank file for the pPCP1 plasmid from *Yersinia pestis biovar Microtus*. The file is included with the Biopython unit tests under the GenBank folder, or you can get it from our website, [NC_005816.gb](http://www.ncbi.nlm.nih.gov/GenBank/NC_005816.gb). This file contains one and only one record, so we can read it in as a `SeqRecord` using the `Bio.SeqIO.read()` function:

```
from Bio import SeqIO
original_rec = SeqIO.read("NC_005816.gb", "genbank")
```

So, how can we generate a shuffled versions of the original sequence? I would use the built in Python `random` module for this, in particular the function `random.shuffle` – but this works on a Python list. Our sequence is a `Seq` object, so in order to shuffle it we need to turn it into a list:

```
import random
nuc_list = list(original_rec.seq)
random.shuffle(nuc_list) #acts in situ!
```

Now, in order to use `Bio.SeqIO` to output the shuffled sequence, we need to construct a new `SeqRecord` with a new `Seq` object using this shuffled list. In order to do this, we need to turn the list of nucleotides (single letter strings) into a long string – the standard Python way to do this is with the string object's `join` method.

```
from Bio.Seq import Seq
from Bio.SeqRecord import SeqRecord
shuffled_rec = SeqRecord(Seq("".join(nuc_list), original_rec.seq.alphabet), \
                          id="Shuffled", description="Based on %s" % original_rec.id)
```

Let's put all these pieces together to make a complete Python script which generates a single FASTA file containing 30 randomly shuffled versions of the original sequence.

This first version just uses a big for loop and writes out the records one by one (using the `SeqRecord`'s `format` method described in Section 5.5.4):

```
import random
from Bio.Seq import Seq
from Bio.SeqRecord import SeqRecord
from Bio import SeqIO

original_rec = SeqIO.read("NC_005816.gb", "genbank")

handle = open("shuffled.fasta", "w")
for i in range(30):
    nuc_list = list(original_rec.seq)
    random.shuffle(nuc_list)
    shuffled_rec = SeqRecord(Seq("".join(nuc_list), original_rec.seq.alphabet), \
                              id="Shuffled%i" % (i+1), \
                              description="Based on %s" % original_rec.id)
    handle.write(shuffled_rec.format("fasta"))
handle.close()
```

Personally I prefer the following version using a function to shuffle the record and a generator expression instead of the for loop:

```
import random
from Bio.Seq import Seq
from Bio.SeqRecord import SeqRecord
from Bio import SeqIO

def make_shuffle_record(record, new_id):
    nuc_list = list(record.seq)
    random.shuffle(nuc_list)
    return SeqRecord(Seq("".join(nuc_list), record.seq.alphabet), \
                    id=new_id, description="Based on %s" % original_rec.id)

original_rec = SeqIO.read("NC_005816.gb", "genbank")
shuffled_recs = (make_shuffle_record(original_rec, "Shuffled%i" % (i+1)) \
                 for i in range(30))
handle = open("shuffled.fasta", "w")
SeqIO.write(shuffled_recs, handle, "fasta")
handle.close()
```

14.1.2 Translating a FASTA file of CDS entries

Suppose you've got an input file of CDS entries for some organism, and you want to generate a new FASTA file containing their protein sequences. i.e. Take each nucleotide sequence from the original file, and translate it. Back in Section 3.9 we saw how to use the `Seq` object's `translate` method, and the optional `cds` argument which enables correct translation of alternative start codons.

We can combine this with `Bio.SeqIO` as shown in the reverse complement example in Section 5.5.3. The key point is that for each nucleotide `SeqRecord`, we need to create a protein `SeqRecord` - and take care of naming it.

You can write your own function to do this, choosing suitable protein identifiers for your sequences, and the appropriate genetic code. In this example we just use the default table and add a prefix to the identifier:

```
from Bio.SeqRecord import SeqRecord
def make_protein_record(nuc_record):
    """Returns a new SeqRecord with the translated sequence (default table)."""
    return SeqRecord(seq = nuc_record.seq.translate(cds=True), \
                     id = "trans_" + nuc_record.id, \
                     description = "translation of CDS, using default table")
```

We can then use this function to turn the input nucleotide records into protein records ready for output. An elegant way and memory efficient way to do this is with a generator expression:

```
from Bio import SeqIO
proteins = (make_protein_record(nuc_rec) for nuc_rec in \
            SeqIO.parse("coding_sequences.fasta", "fasta"))
SeqIO.write(proteins, "translations.fasta", "fasta")
```

This should work on any FASTA file of complete coding sequences. If you are working on partial coding sequences, you may prefer to use `nuc_record.seq.translate(to_stop=True)` in the example above, as this wouldn't check for a valid start codon etc.

14.1.3 Sorting a sequence file

Suppose you wanted to sort a sequence file by length (e.g. a set of contigs from an assembly), and you are working with a file format like FASTA or FASTQ which `Bio.SeqIO` can read, write (and index).

If the file is small enough, you can load it all into memory at once as a list of `SeqRecord` objects, sort the list, and save it:

```
from Bio import SeqIO
records = list(SeqIO.parse("ls_orchid.fasta", "fasta"))
records.sort(cmp=lambda x,y: cmp(len(x),len(y)))
SeqIO.write(records, "sorted_orchids.fasta", "fasta")
```

The only clever bit is specifying a comparison function for how to sort the records (here we sort them by length). If you wanted the longest records first, you could flip the comparison or use the reverse argument:

```
from Bio import SeqIO
records = list(SeqIO.parse("ls_orchid.fasta", "fasta"))
records.sort(cmp=lambda x,y: cmp(len(y),len(x)))
SeqIO.write(records, "sorted_orchids.fasta", "fasta")
```

Now that's pretty straight forward - but what happens if you have a very large file and you can't load it all into memory like this? For example, you might have some next-generation sequencing reads to sort by length. This can be solved using the `Bio.SeqIO.index()` function.

```

from Bio import SeqIO
#Get the lengths and ids, and sort on length
len_and_ids = sorted((len(rec), rec.id) for rec in \
                      SeqIO.parse("ls_orchid.fasta","fasta"))
ids = reversed([id for (length, id) in len_and_ids])
del len_and_ids #free this memory
record_index = SeqIO.index("ls_orchid.fasta", "fasta")
records = (record_index[id] for id in ids)
SeqIO.write(records, "sorted.fasta", "fasta")

```

First we scan through the file once using `Bio.SeqIO.parse()`, recording the record identifiers and their lengths in a list of tuples. We then sort this list to get them in length order, and discard the lengths. Using this sorted list of identifiers `Bio.SeqIO.index()` allows us to retrieve the records one by one, and we pass them to `Bio.SeqIO.write()` for output.

These examples all use `Bio.SeqIO` to parse the records into `SeqRecord` objects which are output using `Bio.SeqIO.write()`. What if you want to sort a file format which `Bio.SeqIO.write()` doesn't support, like the plain text SwissProt format? Here is an alternative solution using the `get_raw()` method added to `Bio.SeqIO.index()` in Biopython 1.54 (see Section 5.4.2).

```

from Bio import SeqIO
#Get the lengths and ids, and sort on length
len_and_ids = sorted((len(rec), rec.id) for rec in \
                      SeqIO.parse("ls_orchid.fasta","fasta"))
ids = reversed([id for (length, id) in len_and_ids])
del len_and_ids #free this memory
record_index = SeqIO.index("ls_orchid.fasta", "fasta")
handle = open("sorted.fasta", "w")
for id in ids:
    handle.write(record_index.get_raw(id))
handle.close()

```

As a bonus, because this never parses the data into `SeqRecord` objects it should be faster.

14.1.4 Simple quality filtering for FASTQ files

The FASTQ file format was introduced at Sanger and is now widely used for holding nucleotide sequencing reads together with their quality scores. FASTQ files (and the related QUAL files) are an excellent example of per-letter-annotation, because for each nucleotide in the sequence there is an associated quality score. Any per-letter-annotation is held in a `SeqRecord` in the `letter_annotations` dictionary as a list, tuple or string (with the same number of elements as the sequence length).

One common task is taking a large set of sequencing reads and filtering them (or cropping them) based on their quality scores. The following example is very simplistic, but should illustrate the basics of working with quality data in a `SeqRecord` object. All we are going to do here is read in a file of FASTQ data, and filter it to pick out only those records whose PHRED quality scores are all above some threshold (here 20).

For this example we'll use some real data downloaded from the NCBI, <ftp://ftp.ncbi.nlm.nih.gov/sra/static/SRX003/SRX003639/SRR014849.fastq.gz> (8MB) which unzips to a 23MB file `SRR014849.fastq`.

```

from Bio import SeqIO
good_reads = (rec for rec in \
              SeqIO.parse("SRR014849.fastq", "fastq") \
              if min(rec.letter_annotations["phred_quality"]) >= 20)
count = SeqIO.write(good_reads, "good_quality.fastq", "fastq")
print "Saved %i reads" % count

```

This pulled out only 412 reads - maybe this dataset hasn't been quality trimmed yet?

FASTQ files can contain millions of entries, so it is best to avoid loading them all into memory at once. This example uses a generator expression, which means only one `SeqRecord` is created at a time - avoiding any memory limitations.

14.1.5 Trimming off primer sequences

For this example we're going to pretend that `GTTGGAACCG` is a 3' primer sequence we want to look for in some FASTQ formatted read data. As in the example above, we'll use the `SRR014849.fastq` file downloaded from the NCBI (<ftp://ftp.ncbi.nlm.nih.gov/sra/static/SRX003/SRX003639/SRR014849.fastq.gz>). The same approach would work with any other supported file format (e.g. FASTA files).

This code uses `Bio.SeqIO` with a generator expression (to avoid loading all the sequences into memory at once), and the `Seq` object's `startswith` method to see if the read starts with the primer sequence:

```
from Bio import SeqIO
primer_reads = (rec for rec in \
    SeqIO.parse("SRR014849.fastq", "fastq") \
    if rec.seq.startswith("GTTGGAACCG"))
count = SeqIO.write(primer_reads, "with_primer.fastq", "fastq")
print "Saved %i reads" % count
```

That should find 500 reads from `SRR014849.fastq` and save them to a new FASTQ file, `with_primer.fastq`.

Now suppose that instead you wanted to make a FASTQ file containing these 500 reads but with the primer sequence removed? That's just a small change as we can slice the `SeqRecord` (see Section 4.6) to remove the first ten letters (the length of our primer):

```
from Bio import SeqIO
trimmed_primer_reads = (rec[10:] for rec in \
    SeqIO.parse("SRR014849.fastq", "fastq") \
    if rec.seq.startswith("GTTGGAACCG"))
count = SeqIO.write(trimmed_primer_reads, "with_primer_trimmed.fastq", "fastq")
print "Saved %i reads" % count
```

Again, that should pull out the 500 reads from `SRR014849.fastq`, but this time strip off the first ten characters, and save them to another new FASTQ file, `with_primer_trimmed.fastq`.

Finally, suppose you want to create a new FASTQ file where these 500 reads have their primer removed, but all the other reads are kept as they were? If we want to still use a generator expression, it is probably clearest to define our own trim function:

```
from Bio import SeqIO
def trim_primer(record, primer):
    if record.seq.startswith(primer):
        return record[len(primer):]
    else:
        return record

trimmed_reads = (trim_primer(record, "GTTGGAACCG") for record in \
    SeqIO.parse("SRR014849.fastq", "fastq"))
count = SeqIO.write(trimmed_reads, "trimmed.fastq", "fastq")
print "Saved %i reads" % count
```

This takes longer, as this time the output file contains all 94696 reads. Again, we're used a generator expression to avoid any memory problems. You could alternatively use a generator function rather than a generator expression.

```

from Bio import SeqIO
def trim_primers(records, primer):
    """Removes perfect primer sequences at start of reads.

    This is a generator function, the records argument should
    be a list or iterator returning SeqRecord objects.
    """
    len_primer = len(primer) #cache this for later
    for record in records:
        if record.seq.startswith(primer):
            yield record[len_primer:]
        else:
            yield record

original_reads = SeqIO.parse("SRR014849.fastq", "fastq")
trimmed_reads = trim_primers(original_reads, "GTTGGAACCG")
count = SeqIO.write(trimmed_reads, "trimmed.fastq", "fastq")
print "Saved %i reads" % count

```

This form is more flexible if you want to do something more complicated where only some of the records are retained – as shown in the next example.

14.1.6 Trimming off adaptor sequences

This is essentially a simple extension to the previous example. We are going to pretend GTTGGAACCG is an adaptor sequence in some FASTQ formatted read data, again the SRR014849.fastq file from the NCBI (<ftp://ftp.ncbi.nlm.nih.gov/sra/static/SRX003/SRX003639/SRR014849.fastq.gz>).

This time however, we will look for the sequence *anywhere* in the reads, not just at the very beginning:

```

from Bio import SeqIO

def trim_adaptors(records, adaptor, min_len):
    """Trims perfect adaptor sequences.

    This is a generator function, the records argument should
    be a list or iterator returning SeqRecord objects.
    """
    len_adaptor = len(adaptor) #cache this for later
    for record in records:
        index = record.seq.find(adaptor)
        if index == -1:
            #adaptor not found, so won't trim
            yield record
        else:
            #trim off the adaptor
            yield record[index+len_adaptor:]

original_reads = SeqIO.parse("SRR014849.fastq", "fastq")
trimmed_reads = trim_adaptors(original_reads, "GTTGGAACCG")
count = SeqIO.write(trimmed_reads, "trimmed.fastq", "fastq")
print "Saved %i reads" % count

```

Because we are using a FASTQ input file in this example, the `SeqRecord` objects have per-letter-annotation for the quality scores. By slicing the `SeqRecord` object the appropriate scores are used on the trimmed records, so we can output them as a FASTQ file too.

Compared to the output of the previous example where we only looked for a primer/adaptor at the start of each read, you may find some of the trimmed reads are quite short after trimming (e.g. if the adaptor was found in the middle rather than near the start). So, let's add a minimum length requirement as well:

```
from Bio import SeqIO

def trim_adaptors(records, adaptor, min_len):
    """Trims perfect adaptor sequences, checks read length.

    This is a generator function, the records argument should
    be a list or iterator returning SeqRecord objects.
    """
    len_adaptor = len(adaptor) #cache this for later
    for record in records:
        len_record = len(record) #cache this for later
        if len(record) < min_len:
            #Too short to keep
            continue
        index = record.seq.find(adaptor)
        if index == -1:
            #adaptor not found, so won't trim
            yield record
        elif len_record - index - len_adaptor >= min_len:
            #after trimming this will still be long enough
            yield record[index+len_adaptor:]

original_reads = SeqIO.parse("SRR014849.fastq", "fastq")
trimmed_reads = trim_adaptors(original_reads, "GTTGGAACCG", 36)
count = SeqIO.write(trimmed_reads, "trimmed.fastq", "fastq")
print "Saved %i reads" % count
```

By changing the format names, you could apply this to FASTA files instead. This code also could be extended to do a fuzzy match instead of an exact match (maybe using a pairwise alignment, or taking into account the read quality scores), but that will be much slower.

14.1.7 Converting FASTQ files

Back in Section 5.5.2 we showed how to use `Bio.SeqIO` to convert between two file formats. Here we'll go into a little more detail regarding FASTQ files which are used in second generation DNA sequencing. Please refer to Cock *et al.* (2009) [doi:10.1093/nar/gkp1137](https://doi.org/10.1093/nar/gkp1137) for a longer description. FASTQ files store both the DNA sequence (as a string) and the associated read qualities.

PHRED scores (used in most FASTQ files, and also in QUAL files, ACE files and SFF files) have become a *de facto* standard for representing the probability of a sequencing error (here denoted by P_e) at a given base using a simple base ten log transformation:

$$Q_{\text{PHRED}} = -10 \times \log_{10}(P_e) \quad (14.1)$$

This means a wrong read ($P_e = 1$) gets a PHRED quality of 0, while a very good read like $P_e = 0.00001$ gets a PHRED quality of 50. While for raw sequencing data qualities higher than this are rare, with post

processing such as read mapping or assembly, qualities of up to about 90 are possible (indeed, the MAQ tool allows for PHRED scores in the range 0 to 93 inclusive).

The FASTQ format has the potential to become a *de facto* standard for storing the letters and quality scores for a sequencing read in a single plain text file. The only fly in the ointment is that there are at least three versions of the FASTQ format which are incompatible and difficult to distinguish...

1. The original Sanger FASTQ format uses PHRED qualities encoded with an ASCII offset of 33. The NCBI are using this format in their Short Read Archive. We call this the `fastq` (or `fastq-sanger`) format in `Bio.SeqIO`.
2. Solexa (later bought by Illumina) introduced their own version using Solexa qualities encoded with an ASCII offset of 64. We call this the `fastq-solexa` format.
3. Illumina pipeline 1.3 onwards produces FASTQ files with PHRED qualities (which is more consistent), but encoded with an ASCII offset of 64. We call this the `fastq-illumina` format.

The Solexa quality scores are defined using a different log transformation:

$$Q_{\text{Solexa}} = -10 \times \log_{10} \left(\frac{P_e}{1 - P_e} \right) \quad (14.2)$$

Given Solexa/Illumina have now moved to using PHRED scores in version 1.3 of their pipeline, the Solexa quality scores will gradually fall out of use. If you equate the error estimates (P_e) these two equations allow conversion between the two scoring systems - and Biopython includes functions to do this in the `Bio.SeqIO.QualityIO` module, which are called if you use `Bio.SeqIO` to convert an old Solexa/Illumina file into a standard Sanger FASTQ file:

```
from Bio import SeqIO
SeqIO.convert("solexa.fastq", "fastq-solexa", "standard.fastq", "fastq")
```

If you want to convert a new Illumina 1.3+ FASTQ file, all that gets changed is the ASCII offset because although encoded differently the scores are all PHRED qualities:

```
from Bio import SeqIO
SeqIO.convert("illumina.fastq", "fastq-illumina", "standard.fastq", "fastq")
```

Note that using `Bio.SeqIO.convert()` like this is *much* faster than combining `Bio.SeqIO.parse()` and `Bio.SeqIO.write()` because optimised code is used for converting between FASTQ variants (and also for FASTQ to FASTA conversion).

For good quality reads, PHRED and Solexa scores are approximately equal, which means since both the `fasta-solexa` and `fastq-illumina` formats use an ASCII offset of 64 the files are almost the same. This was a deliberate design choice by Illumina, meaning applications expecting the old `fasta-solexa` style files will probably be OK using the newer `fastq-illumina` files (on good data). Of course, both variants are very different from the original FASTQ standard as used by Sanger, the NCBI, and elsewhere (format name `fastq` or `fastq-sanger`).

For more details, see the built in help (also [online](#)):

```
>>> from Bio.SeqIO import QualityIO
>>> help(QualityIO)
...
```

14.1.8 Converting FASTA and QUAL files into FASTQ files

FASTQ files hold *both* sequences and their quality strings. FASTA files hold *just* sequences, while QUAL files hold *just* the qualities. Therefore a single FASTQ file can be converted to or from *paired* FASTA and QUAL files.

Going from FASTQ to FASTA is easy:

```
from Bio import SeqIO
SeqIO.convert("example.fastq", "fastq", "example.fasta", "fasta")
```

Going from FASTQ to QUAL is also easy:

```
from Bio import SeqIO
SeqIO.convert("example.fastq", "fastq", "example.qual", "qual")
```

However, the reverse is a little more tricky. You can use `Bio.SeqIO.parse()` to iterate over the records in a *single* file, but in this case we have two input files. There are several strategies possible, but assuming that the two files are really paired the most memory efficient way is to loop over both together. The code is a little fiddly, so we provide a function called `PairedFastaQualIterator` in the `Bio.SeqIO.QualityIO` module to do this. This takes two handles (the FASTA file and the QUAL file) and returns a `SeqRecord` iterator:

```
from Bio.SeqIO.QualityIO import PairedFastaQualIterator
for record in PairedFastaQualIterator(open("example.fasta"), open("example.qual")):
    print record
```

This function will check that the FASTA and QUAL files are consistent (e.g. the records are in the same order, and have the same sequence length). You can combine this with the `Bio.SeqIO.write()` function to convert a pair of FASTA and QUAL files into a single FASTQ files:

```
from Bio import SeqIO
from Bio.SeqIO.QualityIO import PairedFastaQualIterator
handle = open("temp.fastq", "w") #w=write
records = PairedFastaQualIterator(open("example.fasta"), open("example.qual"))
count = SeqIO.write(records, handle, "fastq")
handle.close()
print "Converted %i records" % count
```

14.1.9 Indexing a FASTQ file

FASTQ files are often very large, with millions of reads in them. Due to the sheer amount of data, you can't load all the records into memory at once. This is why the examples above (filtering and trimming) iterate over the file looking at just one `SeqRecord` at a time.

However, sometimes you can't use a big loop or an iterator - you may need random access to the reads. Here the `Bio.SeqIO.index()` function may prove very helpful, as it allows you to access any read in the FASTQ file by its name (see Section 5.4).

Again we'll use the `SRR014849.fastq` file from the NCBI (<ftp://ftp.ncbi.nlm.nih.gov/sra/static/SRX003/SRX003639/SRR014849.fastq.gz>), although this is actually quite a small FASTQ file with less than 100,000 reads:

```
>>> from Bio import SeqIO
>>> fq_dict = SeqIO.index("SRR014849.fastq", "fastq")
>>> len(fq_dict)
94696
```

```
fq_dict.keys()[:4]
['SRR014849.80961', 'SRR014849.80960', 'SRR014849.80963', 'SRR014849.288943']
>>> fq_dict["SRR014849.171880"].seq
Seq('AAAATCATCTCTGGCGCCCGTTGGAACCGAAAGGGTTGAATTCAAACCCTTT...CAG', SingleLetterAlphabet())
```

When testing this on a FASTQ file with seven million reads, indexing took about a minute, but record access was almost instant.

The example in Section 14.1.3 show how you can use the `Bio.SeqIO.index()` function to sort a large FASTA file – this could also be used on FASTQ files.

14.1.10 Converting SFF files

If you work with 454 (Roche) sequence data, you will probably have access to the raw data as an Standard Flowgram Format (SFF) file. This contains the sequence reads (called bases) with quality scores and the original flow information.

A common task is to convert from SFF to a pair of FASTA and QUAL files, or to a single FASTQ file. These operations are trivial using the `Bio.SeqIO.convert()` function (see Section 5.5.2):

```
>>> from Bio import SeqIO
>>> SeqIO.convert("E3MFGYR02_random_10_reads.sff", "sff", "reads.fasta", "fasta")
10
>>> SeqIO.convert("E3MFGYR02_random_10_reads.sff", "sff", "reads.qual", "qual")
10
>>> SeqIO.convert("E3MFGYR02_random_10_reads.sff", "sff", "reads.fastq", "fastq")
10
```

Remember the `convert` function returns the number of records, in this example just ten. This will give you the *untrimmed* reads, where the leading and trailing poor quality sequence or adaptor will be in lower case. If you want the *trimmed* reads (using the clipping information recorded within the SFF file) use this:

```
>>> from Bio import SeqIO
>>> SeqIO.convert("E3MFGYR02_random_10_reads.sff", "sff-trim", "trimmed.fasta", "fasta")
10
>>> SeqIO.convert("E3MFGYR02_random_10_reads.sff", "sff-trim", "trimmed.qual", "qual")
10
>>> SeqIO.convert("E3MFGYR02_random_10_reads.sff", "sff-trim", "trimmed.fastq", "fastq")
10
```

If you run Linux, you could ask Roche for a copy of their “off instrument” tools (often referred to as the Newbler tools). This offers an alternative way to do SFF to FASTA or QUAL conversion at the command line (but currently FASTQ output is not supported), e.g.

```
$ sffinfo -seq -notrim E3MFGYR02_random_10_reads.sff > reads.fasta
$ sffinfo -qual -notrim E3MFGYR02_random_10_reads.sff > reads.qual
$ sffinfo -seq -trim E3MFGYR02_random_10_reads.sff > trimmed.fasta
$ sffinfo -qual -trim E3MFGYR02_random_10_reads.sff > trimmed.qual
```

The way Biopython uses mixed case sequence strings to represent the trimming points deliberately mimics what the Roche tools do.

For more information on the Biopython SFF support, consult the built in help:

```
>>> from Bio.SeqIO import SffIO
>>> help(SffIO)
...
```

14.1.11 Identifying open reading frames

A very simplistic first step at identifying possible genes is to look for open reading frames (ORFs). By this we mean look in all six frames for long regions without stop codons – an ORF is just a region of nucleotides with no in frame stop codons.

Of course, to find a gene you would also need to worry about locating a start codon, possible promoters – and in Eukaryotes there are introns to worry about too. However, this approach is still useful in viruses and Prokaryotes.

To show how you might approach this with Biopython, we'll need a sequence to search, and as an example we'll again use the bacterial plasmid – although this time we'll start with a plain FASTA file with no pre-marked genes: [NC.005816.fna](#). This is a bacterial sequence, so we'll want to use NCBI codon table 11 (see Section 3.9 about translation).

```
from Bio import SeqIO
record = SeqIO.read("NC_005816.fna", "fasta")
table = 11
min_pro_len = 100
```

Here is a neat trick using the Seq object's `split` method to get a list of all the possible ORF translations in the six reading frames:

```
for strand, nuc in [(+1, record.seq), (-1, record.seq.reverse_complement())]:
    for frame in range(3):
        for pro in nuc[frame:].translate(table).split("*"):
            if len(pro) >= min_pro_len:
                print "%s...%s - length %i, strand %i, frame %i" \
                    % (pro[:30], pro[-3:], len(pro), strand, frame)
```

This should give:

```
GCLMKKSSIVATIITILSGSANAASSQLIP...YRF - length 315, strand 1, frame 0
KSGELRQTPPASSTLHLRLILQRSGVMEL...NPE - length 285, strand 1, frame 1
GLNCSFFSICNWKFIDYINRLFQIIYLCKN...YYH - length 176, strand 1, frame 1
VKKILYIKALFLCTVIKLRRFIFSVNNMKF...DLP - length 165, strand 1, frame 1
NQIQQVICSPDSGEFMVTFETVMEIKILHK...GVA - length 355, strand 1, frame 2
RRKEHVSKRRRPQKRPRRRFFHRLRPPDE...PTR - length 128, strand 1, frame 2
TGKQNSCQMSAIWQLRQNTATKTRQNRARI...AIK - length 100, strand 1, frame 2
QGGSYAFPHASILSGIAMSHFYFLVLHAVK...CSD - length 114, strand -1, frame 0
IYSTSEHTGEQVMRTLDEVIASRSPESQTR...FHV - length 111, strand -1, frame 0
WGKLQVIGLSMWMVLFSQLRFDLWNEQEDA...ESK - length 125, strand -1, frame 1
RGIFMSDTMVVNGSGGVPALFSGSTLSSY...LLK - length 361, strand -1, frame 1
WDVKTVTGVLHHPFHLTFSLCPEGATQSGR...VKR - length 111, strand -1, frame 1
LSHTVTDFTDQMAQVGLCQCVNVFLDEVTG...KAA - length 107, strand -1, frame 2
RALTGLSAPGIRSQTSCDRLRELRYVPVSL...PLQ - length 119, strand -1, frame 2
```

Note that here we are counting the frames from the 5' end (start) of *each* strand. It is sometimes easier to always count from the 5' end (start) of the *forward* strand.

You could easily edit the above loop based code to build up a list of the candidate proteins, or convert this to a list comprehension. Now, one thing this code doesn't do is keep track of where the proteins are.

You could tackle this in several ways. For example, the following code tracks the locations in terms of the protein counting, and converts back to the parent sequence by multiplying by three, then adjusting for the frame and strand:

```

from Bio import SeqIO
record = SeqIO.read("NC_005816.gb", "genbank")
table = 11
min_pro_len = 100

def find_orfs_with_trans(seq, trans_table, min_protein_length):
    answer = []
    seq_len = len(seq)
    for strand, nuc in [(+1, seq), (-1, seq.reverse_complement())]:
        for frame in range(3):
            trans = str(nuc[frame:].translate(trans_table))
            trans_len = len(trans)
            aa_start = 0
            aa_end = 0
            while aa_start < trans_len:
                aa_end = trans.find("*", aa_start)
                if aa_end == -1:
                    aa_end = trans_len
                if aa_end-aa_start >= min_protein_length:
                    if strand == 1:
                        start = frame+aa_start*3
                        end = min(seq_len, frame+aa_end*3+3)
                    else:
                        start = seq_len-frame-aa_end*3-3
                        end = seq_len-frame-aa_start*3
                    answer.append((start, end, strand,
                                   trans[aa_start:aa_end]))
                    aa_start = aa_end+1
    answer.sort()
    return answer

orf_list = find_orfs_with_trans(record.seq, table, min_pro_len)
for start, end, strand, pro in orf_list:
    print "%s...%s - length %i, strand %i, %i:%i" \
          % (pro[:30], pro[-3:], len(pro), strand, start, end)

```

And the output:

```

NQIQGVICSPDSGEFMVTFETVMEIKILHK...GVA - length 355, strand 1, 41:1109
WDVKTVTGVLHHPFHLTFSLCPEGATQSGR...VKR - length 111, strand -1, 491:827
KSGELRQTTPPASSTLHLRLILQRSGVMEL...NPE - length 285, strand 1, 1030:1888
RALTGLSAPGIRSQTSCDRLRELRYVPVSL...PLQ - length 119, strand -1, 2830:3190
RRKEHVSKKRRPQKRPRRRFFHRLRPPDE...PTR - length 128, strand 1, 3470:3857
GLNCSFFSICNWKFIDYINRLFQIIYLCKN...YYH - length 176, strand 1, 4249:4780
RGIFMSDTMVVNGSGGVP AFLFSGSTLSSY...LLK - length 361, strand -1, 4814:5900
VKKILYIKALFLCTVIKLRRFIFSVNNMKF...DLP - length 165, strand 1, 5923:6421
LSHTVTDFTDQMAQVGLCQCVNVFLDEV TG...KAA - length 107, strand -1, 5974:6298
GCLMKKSSIVATIIITILSGSANAASSQLIP...YRF - length 315, strand 1, 6654:7602
IYSTSEHTGEQVMRTLDEVIASRSPESQTR...FHV - length 111, strand -1, 7788:8124
WGKLQVIGLSMVMVLFQSRFDDWLNEQEDA...ESK - length 125, strand -1, 8087:8465
TGKQNSCQMSAIWQLRQNTATKTRQNRARI...AIK - length 100, strand 1, 8741:9044
QSGGYAFPHASILSGIAMSHFYFLVLHAVK...CSD - length 114, strand -1, 9264:9609

```

If you comment out the sort statement, then the protein sequences will be shown in the same order as before, so you can check this is doing the same thing. Here we have sorted them by location to make it easier to compare to the actual annotation in the GenBank file (as visualised in Section 13.1.8).

If however all you want to find are the locations of the open reading frames, then it is a waste of time to translate every possible codon, including doing the reverse complement to search the reverse strand too. All you need to do is search for the possible stop codons (and their reverse complements). Using regular expressions is an obvious approach here (see the Python module `re`). These are an extremely powerful (but rather complex) way of describing search strings, which are supported in lots of programming languages and also command line tools like `grep` as well). You can find whole books about this topic!

14.2 Sequence parsing plus simple plots

This section shows some more examples of sequence parsing, using the `Bio.SeqIO` module described in Chapter 5, plus the Python library `matplotlib`'s `pylab` plotting interface (see [the matplotlib website for a tutorial](#)). Note that to follow these examples you will need `matplotlib` installed - but without it you can still try the data parsing bits.

14.2.1 Histogram of sequence lengths

There are lots of times when you might want to visualise the distribution of sequence lengths in a dataset – for example the range of contig sizes in a genome assembly project. In this example we'll reuse our orchid FASTA file `ls_orchid.fasta` which has only 94 sequences.

First of all, we will use `Bio.SeqIO` to parse the FASTA file and compile a list of all the sequence lengths. You could do this with a for loop, but I find a list comprehension more pleasing:

```
>>> from Bio import SeqIO
>>> handle = open("ls_orchid.fasta")
>>> sizes = [len(seq_record) for seq_record in SeqIO.parse(handle, "fasta")]
>>> handle.close()
>>> len(sizes), min(sizes), max(sizes)
(94, 572, 789)
>>> sizes
[740, 753, 748, 744, 733, 718, 730, 704, 740, 709, 700, 726, ..., 592]
```

Now that we have the lengths of all the genes (as a list of integers), we can use the `matplotlib` histogram function to display it.

```
from Bio import SeqIO
handle = open("ls_orchid.fasta")
sizes = [len(seq_record) for seq_record in SeqIO.parse(handle, "fasta")]
handle.close()

import pylab
pylab.hist(sizes, bins=20)
pylab.title("%i orchid sequences\nLengths %i to %i" \
            % (len(sizes),min(sizes),max(sizes)))
pylab.xlabel("Sequence length (bp)")
pylab.ylabel("Count")
pylab.show()
```

That should pop up a new window containing the graph shown in Figure 14.1. Notice that most of these orchid sequences are about 740 bp long, and there could be two distinct classes of sequence here with a subset of shorter sequences.

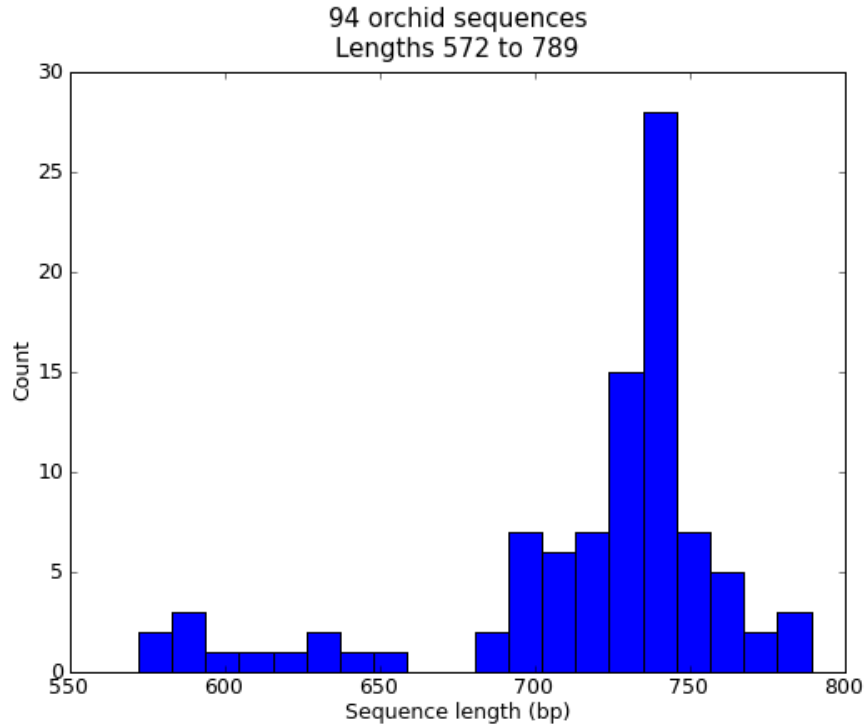

Figure 14.1: Histogram of orchid sequence lengths.

Tip: Rather than using `pylab.show()` to show the plot in a window, you can also use `pylab.savefig(...)` to save the figure to a file (e.g. as a PNG or PDF).

14.2.2 Plot of sequence GC%

Another easily calculated quantity of a nucleotide sequence is the GC%. You might want to look at the GC% of all the genes in a bacterial genome for example, and investigate any outliers which could have been recently acquired by horizontal gene transfer. Again, for this example we'll reuse our orchid FASTA file [ls_orchid.fasta](#).

First of all, we will use `Bio.SeqIO` to parse the FASTA file and compile a list of all the GC percentages. Again, you could do this with a for loop, but I prefer the list comprehension used here:

```
from Bio import SeqIO
from Bio.SeqUtils import GC

handle = open("ls_orchid.fasta")
gc_values = [GC(seq_record.seq) for seq_record in SeqIO.parse(handle, "fasta")]
gc_values.sort()
handle.close()
```

Having read in each sequence and calculated the GC%, we then sorted them into ascending order. Now we'll take this list of floating point values and plot them with `matplotlib`:

```
import pylab
pylab.plot(gc_values)
```

```

pylab.title("%i orchid sequences\nGC%% %0.1f to %0.1f" \
            % (len(gc_values),min(gc_values),max(gc_values)))
pylab.xlabel("Genes")
pylab.ylabel("GC%")
pylab.show()

```

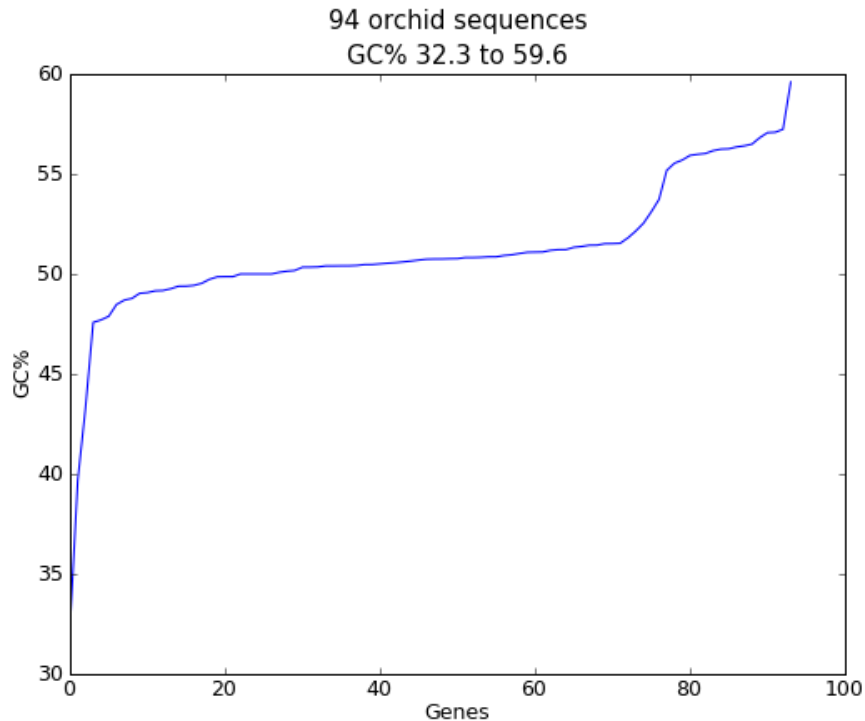

Figure 14.2: Histogram of orchid sequence lengths.

As in the previous example, that should pop up a new window with the graph shown in Figure 14.2. If you tried this on the full set of genes from one organism, you'd probably get a much smoother plot than this.

14.2.3 Nucleotide dot plots

A dot plot is a way of visually comparing two nucleotide sequences for similarity to each other. A sliding window is used to compare short sub-sequences to each other, often with a mis-match threshold. Here for simplicity we'll only look for perfect matches (shown in black in Figure 14.3).

To start off, we'll need two sequences. For the sake of argument, we'll just take the first two from our orchid FASTA file `ls_orchid.fasta`:

```

from Bio import SeqIO
handle = open("ls_orchid.fasta")
record_iterator = SeqIO.parse(handle, "fasta")
rec_one = record_iterator.next()
rec_two = record_iterator.next()
handle.close()

```

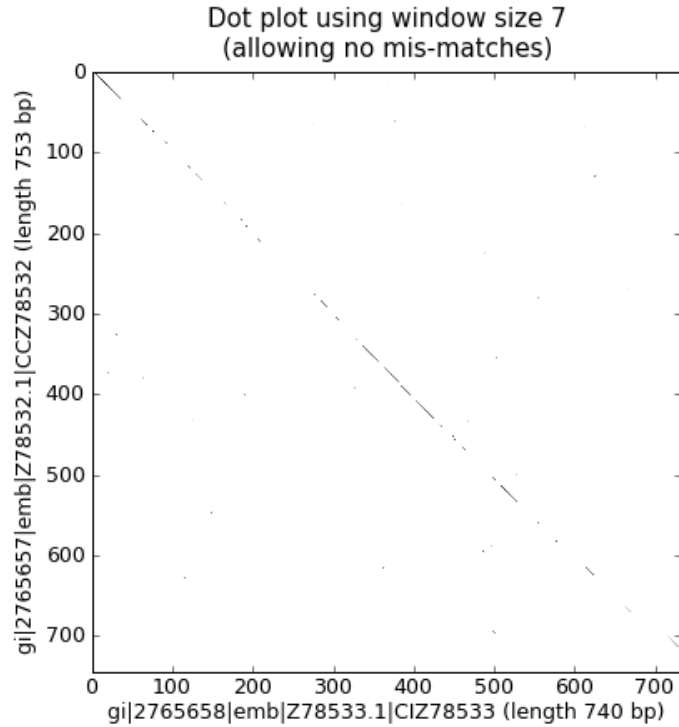

Figure 14.3: Nucleotide dot plot of two orchid sequence lengths (using pylab's imshow function).

We're going to show two approaches. Firstly, a simple naive implementation which compares all the window sized sub-sequences to each other to compile a similarity matrix. You could construct a matrix or array object, but here we just use a list of lists of booleans created with a nested list comprehension:

```

window = 7
seq_one = str(rec_one.seq).upper()
seq_two = str(rec_two.seq).upper()
data = [[(seq_one[i:i+window] <> seq_two[j:j+window]) \
         for j in range(len(seq_one)-window)] \
        for i in range(len(seq_two)-window)]

```

Note that we have *not* checked for reverse complement matches here. Now we'll use the matplotlib's `pylab.imshow()` function to display this data, first requesting the gray color scheme so this is done in black and white:

```

import pylab
pylab.gray()
pylab.imshow(data)
pylab.xlabel("%s (length %i bp)" % (rec_one.id, len(rec_one)))
pylab.ylabel("%s (length %i bp)" % (rec_two.id, len(rec_two)))
pylab.title("Dot plot using window size %i\n(allowing no mis-matches)" % window)
pylab.show()

```

That should pop up a new window showing the graph in Figure 14.3. As you might have expected, these two sequences are very similar with a partial line of window sized matches along the diagonal. There are no off diagonal matches which would be indicative of inversions or other interesting events.

The above code works fine on small examples, but there are two problems applying this to larger sequences, which we will address below. First off all, this brute force approach to the all against all comparisons is very slow. Instead, we'll compile dictionaries mapping the window sized sub-sequences to their locations, and then take the set intersection to find those sub-sequences found in both sequences. This uses more memory, but is *much* faster. Secondly, the `pylab.imshow()` function is limited in the size of matrix it can display. As an alternative, we'll use the `pylab.scatter()` function.

We start by creating dictionaries mapping the window-sized sub-sequences to locations:

```

window = 7
dict_one = {}
dict_two = {}
for (seq, section_dict) in [(str(rec_one.seq).upper(), dict_one),
                           (str(rec_two.seq).upper(), dict_two)]:
    for i in range(len(seq)-window):
        section = seq[i:i+window]
        try:
            section_dict[section].append(i)
        except KeyError:
            section_dict[section] = [i]
#Now find any sub-sequences found in both sequences
#(Python 2.3 would require slightly different code here)
matches = set(dict_one).intersection(dict_two)
print "%i unique matches" % len(matches)

```

In order to use the `pylab.scatter()` we need separate lists for the *x* and *y* co-ordinates:

```

#Create lists of x and y co-ordinates for scatter plot
x = []
y = []
for section in matches:
    for i in dict_one[section]:
        for j in dict_two[section]:
            x.append(i)
            y.append(j)

```

We are now ready to draw the revised dot plot as a scatter plot:

```

import pylab
pylab.cla() #clear any prior graph
pylab.gray()
pylab.scatter(x,y)
pylab.xlim(0, len(rec_one)-window)
pylab.ylim(0, len(rec_two)-window)
pylab.xlabel("%s (length %i bp)" % (rec_one.id, len(rec_one)))
pylab.ylabel("%s (length %i bp)" % (rec_two.id, len(rec_two)))
pylab.title("Dot plot using window size %i\n(allowing no mis-matches)" % window)
pylab.show()

```

That should pop up a new window showing the graph in Figure 14.4. Personally I find this second plot much easier to read! Again note that we have *not* checked for reverse complement matches here – you could extend this example to do this, and perhaps plot the forward matches in one color and the reverse matches in another.

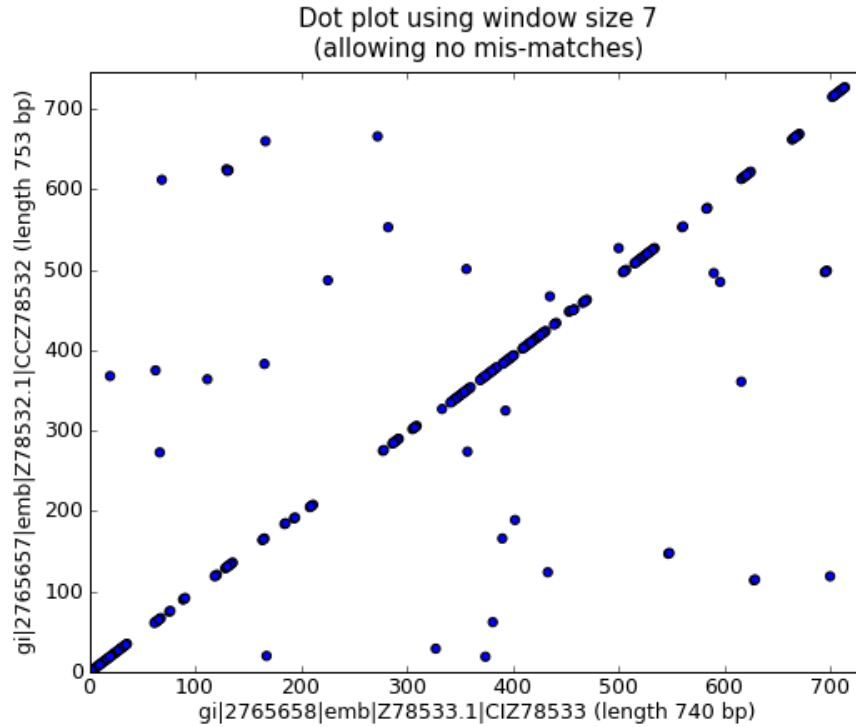

Figure 14.4: Nucleotide dot plot of two orchid sequence lengths (using pylab's scatter function).

14.2.4 Plotting the quality scores of sequencing read data

If you are working with second generation sequencing data, you may want to try plotting the quality data. Here is an example using two FASTQ files containing paired end reads, `SRR001666_1.fastq` for the forward reads, and `SRR001666_2.fastq` for the reverse reads. These were downloaded from the NCBI short read archive (SRA) FTP site (see the [SRR001666 page](#) and <ftp://ftp.ncbi.nlm.nih.gov/sra/static/SRX000/SRX000430/> for details).

In the following code the `pylab.subplot(...)` function is used in order to show the forward and reverse qualities on two subplots, side by side. There is also a little bit of code to only plot the first fifty reads.

```
import pylab
from Bio import SeqIO
for subfigure in [1,2]:
    filename = "SRR001666_%i.fastq" % subfigure
    pylab.subplot(1, 2, subfigure)
    for i,record in enumerate(SeqIO.parse(filename, "fastq")):
        if i >= 50 : break #trick!
        pylab.plot(record.letter_annotations["phred_quality"])
    pylab.ylim(0,45)
    pylab.ylabel("PHRED quality score")
    pylab.xlabel("Position")
pylab.savefig("SRR001666.png")
print "Done"
```

You should note that we are using the `Bio.SeqIO` format name `fastq` here because the NCBI has saved these reads using the standard Sanger FASTQ format with PHRED scores. However, as you might guess

from the read lengths, this data was from an Illumina Genome Analyzer and was probably originally in one of the two Solexa/Illumina FASTQ variant file formats instead.

This example uses the `pylab.savefig(...)` function instead of `pylab.show(...)`, but as mentioned before both are useful. The result is shown in Figure 14.5.

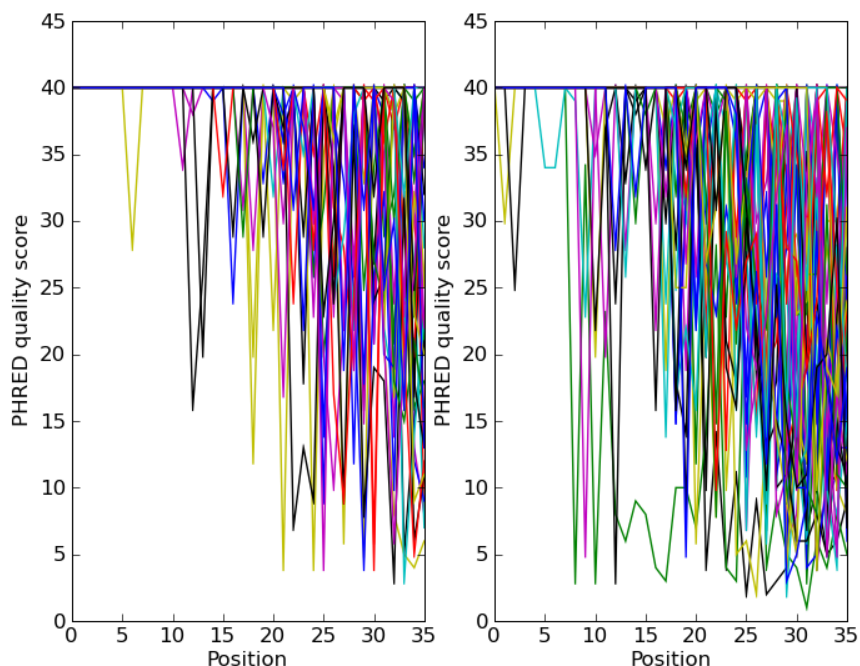

Figure 14.5: Quality plot for some paired end reads.

14.3 Dealing with alignments

This section can be seen as a follow on to Chapter 6.

14.3.1 Calculating summary information

Once you have an alignment, you are very likely going to want to find out information about it. Instead of trying to have all of the functions that can generate information about an alignment in the alignment object itself, we've tried to separate out the functionality into separate classes, which act on the alignment.

Getting ready to calculate summary information about an object is quick to do. Let's say we've got an alignment object called `alignment`, for example read in using `Bio.AlignIO.read(...)` as described in Chapter 6. All we need to do to get an object that will calculate summary information is:

```
from Bio.Align import AlignInfo
summary_align = AlignInfo.SummaryInfo(alignment)
```

The `summary_align` object is very useful, and will do the following neat things for you:

1. Calculate a quick consensus sequence – see section 14.3.2

2. Get a position specific score matrix for the alignment – see section [14.3.3](#)
3. Calculate the information content for the alignment – see section [14.3.4](#)
4. Generate information on substitutions in the alignment – section [14.4](#) details using this to generate a substitution matrix.

14.3.2 Calculating a quick consensus sequence

The `SummaryInfo` object, described in section [14.3.1](#), provides functionality to calculate a quick consensus of an alignment. Assuming we've got a `SummaryInfo` object called `summary_align` we can calculate a consensus by doing:

```
consensus = summary_align.dumb_consensus()
```

As the name suggests, this is a really simple consensus calculator, and will just add up all of the residues at each point in the consensus, and if the most common value is higher than some threshold value will add the common residue to the consensus. If it doesn't reach the threshold, it adds an ambiguity character to the consensus. The returned consensus object is `Seq` object whose alphabet is inferred from the alphabets of the sequences making up the consensus. So doing a `print consensus` would give:

```
consensus Seq('TATACATNAAAGNAGGGGGATGCGGATAAATGGAAAGGCGAAAGAAAGAAAAAATGAAT
...', IUPACAmbiguousDNA())
```

You can adjust how `dumb_consensus` works by passing optional parameters:

the threshold This is the threshold specifying how common a particular residue has to be at a position before it is added. The default is 0.7 (meaning 70%).

the ambiguous character This is the ambiguity character to use. The default is 'N'.

the consensus alphabet This is the alphabet to use for the consensus sequence. If an alphabet is not specified than we will try to guess the alphabet based on the alphabets of the sequences in the alignment.

14.3.3 Position Specific Score Matrices

Position specific score matrices (PSSMs) summarize the alignment information in a different way than a consensus, and may be useful for different tasks. Basically, a PSSM is a count matrix. For each column in the alignment, the number of each alphabet letters is counted and totaled. The totals are displayed relative to some representative sequence along the left axis. This sequence may be the consensus sequence, but can also be any sequence in the alignment. For instance for the alignment,

```
GTATC
AT--C
CTGTC
```

the PSSM is:

```

  G A T C
G 1 1 0 1
T 0 0 3 0
A 1 1 0 0
T 0 0 2 0
C 0 0 0 3
```

Let's assume we've got an alignment object called `c_align`. To get a PSSM with the consensus sequence along the side we first get a summary object and calculate the consensus sequence:

```
summary_align = AlignInfo.SummaryInfo(c_align)
consensus = summary_align.dumb_consensus()
```

Now, we want to make the PSSM, but ignore any N ambiguity residues when calculating this:

```
my_pssm = summary_align.pos_specific_score_matrix(consensus,
                                                chars_to_ignore = ['N'])
```

Two notes should be made about this:

1. To maintain strictness with the alphabets, you can only include characters along the top of the PSSM that are in the alphabet of the alignment object. Gaps are not included along the top axis of the PSSM.
2. The sequence passed to be displayed along the left side of the axis does not need to be the consensus. For instance, if you wanted to display the second sequence in the alignment along this axis, you would need to do:

```
second_seq = alignment.get_seq_by_num(1)
my_pssm = summary_align.pos_specific_score_matrix(second_seq
                                                chars_to_ignore = ['N'])
```

The command above returns a PSSM object. To print out the PSSM as we showed above, we simply need to do a `print my_pssm`, which gives:

```
   A   C   G   T
T  0.0 0.0 0.0 7.0
A  7.0 0.0 0.0 0.0
T  0.0 0.0 0.0 7.0
A  7.0 0.0 0.0 0.0
C  0.0 7.0 0.0 0.0
A  7.0 0.0 0.0 0.0
T  0.0 0.0 0.0 7.0
T  1.0 0.0 0.0 6.0
...
```

You can access any element of the PSSM by subscripting like `your_pssm[sequence_number][residue_count_name]`. For instance, to get the counts for the 'A' residue in the second element of the above PSSM you would do:

```
>>> print my_pssm[1]["A"]
7.0
```

The structure of the PSSM class hopefully makes it easy both to access elements and to pretty print the matrix.

14.3.4 Information Content

A potentially useful measure of evolutionary conservation is the information content of a sequence.

A useful introduction to information theory targetted towards molecular biologists can be found at <http://www.lecb.ncifcrf.gov/~toms/paper/primer/>. For our purposes, we will be looking at the information content of a consensus sequence, or a portion of a consensus sequence. We calculate information content at a particular column in a multiple sequence alignment using the following formula:

$$IC_j = \sum_{i=1}^{N_a} P_{ij} \log \left(\frac{P_{ij}}{Q_i} \right)$$

where:

- IC_j – The information content for the j -th column in an alignment.
- N_a – The number of letters in the alphabet.
- P_{ij} – The frequency of a particular letter i in the j -th column (i. e. if G occurred 3 out of 6 times in an alignment column, this would be 0.5)
- Q_i – The expected frequency of a letter i . This is an optional argument, usage of which is left at the user's discretion. By default, it is automatically assigned to $0.05 = 1/20$ for a protein alphabet, and $0.25 = 1/4$ for a nucleic acid alphabet. This is for getting the information content without any assumption of prior distributions. When assuming priors, or when using a non-standard alphabet, you should supply the values for Q_i .

Well, now that we have an idea what information content is being calculated in Biopython, let's look at how to get it for a particular region of the alignment.

First, we need to use our alignment to get a alignment summary object, which we'll assume is called `summary_align` (see section 14.3.1) for instructions on how to get this. Once we've got this object, calculating the information content for a region is as easy as:

```
info_content = summary_align.information_content(5, 30,
                                                chars_to_ignore = ['N'])
```

Wow, that was much easier than the formula above made it look! The variable `info_content` now contains a float value specifying the information content over the specified region (from 5 to 30 of the alignment). We specifically ignore the ambiguity residue 'N' when calculating the information content, since this value is not included in our alphabet (so we shouldn't be interested in looking at it!).

As mentioned above, we can also calculate relative information content by supplying the expected frequencies:

```
expect_freq = {
    'A' : .3,
    'G' : .2,
    'T' : .3,
    'C' : .2}
```

The expected should not be passed as a raw dictionary, but instead by passed as a `SubsMat.FreqTable` object (see section 16.2.2 for more information about `FreqTables`). The `FreqTable` object provides a standard for associating the dictionary with an `Alphabet`, similar to how the Biopython `Seq` class works.

To create a `FreqTable` object, from the frequency dictionary you just need to do:

```

from Bio.Alphabet import IUPAC
from Bio.SubsMat import FreqTable

e_freq_table = FreqTable.FreqTable(expect_freq, FreqTable.FREQ,
                                   IUPAC.unambiguous_dna)

```

Now that we've got that, calculating the relative information content for our region of the alignment is as simple as:

```

info_content = summary_align.information_content(5, 30,
                                                e_freq_table = e_freq_table,
                                                chars_to_ignore = ['N'])

```

Now, `info_content` will contain the relative information content over the region in relation to the expected frequencies.

The value return is calculated using base 2 as the logarithm base in the formula above. You can modify this by passing the parameter `log_base` as the base you want:

```

info_content = summary_align.information_content(5, 30, log_base = 10,
                                                chars_to_ignore = ['N'])

```

Well, now you are ready to calculate information content. If you want to try applying this to some real life problems, it would probably be best to dig into the literature on information content to get an idea of how it is used. Hopefully your digging won't reveal any mistakes made in coding this function!

14.4 Substitution Matrices

Substitution matrices are an extremely important part of everyday bioinformatics work. They provide the scoring terms for classifying how likely two different residues are to substitute for each other. This is essential in doing sequence comparisons. The book "Biological Sequence Analysis" by Durbin et al. provides a really nice introduction to Substitution Matrices and their uses. Some famous substitution matrices are the PAM and BLOSUM series of matrices.

Biopython provides a ton of common substitution matrices, and also provides functionality for creating your own substitution matrices.

14.4.1 Using common substitution matrices

14.4.2 Creating your own substitution matrix from an alignment

A very cool thing that you can do easily with the substitution matrix classes is to create your own substitution matrix from an alignment. In practice, this is normally done with protein alignments. In this example, we'll first get a Biopython alignment object and then get a summary object to calculate info about the alignment. The file containing [protein.aln](#) (also available online [here](#)) contains the Clustalw alignment output.

```

from Bio import Clustalw
from Bio.Alphabet import IUPAC
from Bio.Align import AlignInfo

# get an alignment object from a Clustalw alignment output
c_align = Clustalw.parse_file("protein.aln", IUPAC.protein)
summary_align = AlignInfo.SummaryInfo(c_align)

```

Sections 6.4.1 and 14.3.1 contain more information on doing this.

Now that we've got our `summary_align` object, we want to use it to find out the number of times different residues substitute for each other. To make the example more readable, we'll focus on only amino acids with polar charged side chains. Luckily, this can be done easily when generating a replacement dictionary, by passing in all of the characters that should be ignored. Thus we'll create a dictionary of replacements for only charged polar amino acids using:

```
replace_info = summary_align.replacement_dictionary(["G", "A", "V", "L", "I",
                                                    "M", "P", "F", "W", "S",
                                                    "T", "N", "Q", "Y", "C"])
```

This information about amino acid replacements is represented as a python dictionary which will look something like:

```
{('R', 'R'): 2079.0, ('R', 'H'): 17.0, ('R', 'K'): 103.0, ('R', 'E'): 2.0,
 ('R', 'D'): 2.0, ('H', 'R'): 0, ('D', 'H'): 15.0, ('K', 'K'): 3218.0,
 ('K', 'H'): 24.0, ('H', 'K'): 8.0, ('E', 'H'): 15.0, ('H', 'H'): 1235.0,
 ('H', 'E'): 18.0, ('H', 'D'): 0, ('K', 'D'): 0, ('K', 'E'): 9.0,
 ('D', 'R'): 48.0, ('E', 'R'): 2.0, ('D', 'K'): 1.0, ('E', 'K'): 45.0,
 ('K', 'R'): 130.0, ('E', 'D'): 241.0, ('E', 'E'): 3305.0,
 ('D', 'E'): 270.0, ('D', 'D'): 2360.0}
```

This information gives us our accepted number of replacements, or how often we expect different things to substitute for each other. It turns out, amazingly enough, that this is all of the information we need to go ahead and create a substitution matrix. First, we use the replacement dictionary information to create an Accepted Replacement Matrix (ARM):

```
from Bio import SubsMat
my_arm = SubsMat.SeqMat(replace_info)
```

With this accepted replacement matrix, we can go right ahead and create our log odds matrix (i. e. a standard type Substitution Matrix):

```
my_lom = SubsMat.make_log_odds_matrix(my_arm)
```

The log odds matrix you create is customizable with the following optional arguments:

- `exp_freq_table` - You can pass a table of expected frequencies for each alphabet. If supplied, this will be used instead of the passed accepted replacement matrix when calculate expected replacements.
- `logbase` - The base of the logarithm taken to create the log odd matrix. Defaults to base 10.
- `factor` - The factor to multiply each matrix entry by. This defaults to 10, which normally makes the matrix numbers easy to work with.
- `round_digit` - The digit to round to in the matrix. This defaults to 0 (i. e. no digits).

Once you've got your log odds matrix, you can display it prettily using the function `print_mat`. Doing this on our created matrix gives:

```
>>> my_lom.print_mat()
D   6
E  -5  5
H -15 -13 10
K -31 -15 -13  6
R -13 -25 -14 -7  7
  D   E   H   K   R
```

Very nice. Now we've got our very own substitution matrix to play with!

14.5 BioSQL – storing sequences in a relational database

BioSQL is a joint effort between the OBF projects (BioPerl, BioJava etc) to support a shared database schema for storing sequence data. In theory, you could load a GenBank file into the database with BioPerl, then using Biopython extract this from the database as a record object with features - and get more or less the same thing as if you had loaded the GenBank file directly as a SeqRecord using `Bio.SeqIO` (Chapter 5).

Biopython's BioSQL module is currently documented at <http://biopython.org/wiki/BioSQL> which is part of our wiki pages.

14.6 InterPro

The `Bio.InterPro` module works with files from the InterPro database, which can be obtained from the InterPro project: <http://www.ebi.ac.uk/interpro/>.

The `Bio.InterPro.Record` contains all the information stored in an InterPro record. Its string representation also is a valid InterPro record, but it is NOT guaranteed to be equivalent to the record from which it was produced.

The `Bio.InterPro.Record` contains:

- Database
- Accession
- Name
- Dates
- Type
- Parent
- Process
- Function
- Component
- Signatures
- Abstract
- Examples
- References
- Database links

Chapter 15

The Biopython testing framework

Biopython has a regression testing framework (the file `run_tests.py`) based on `unittest`, the standard unit testing framework for Python. Providing comprehensive tests for modules is one of the most important aspects of making sure that the Biopython code is as bug-free as possible before going out. It also tends to be one of the most undervalued aspects of contributing. This chapter is designed to make running the Biopython tests and writing good test code as easy as possible. Ideally, every module that goes into Biopython should have a test (and should also have documentation!). All our developers, and anyone installing Biopython from source, are strongly encouraged to run the unit tests.

15.1 Running the tests

When you download the Biopython source code, or check it out from our source code repository, you should find a subdirectory called `Tests`. This contains the key script `run_tests.py`, lots of individual scripts named `test_XXX.py`, a subdirectory called `output` and lots of other subdirectories which contain input files for the test suite.

As part of building and installing Biopython you will typically run the full test suite at the command line from the Biopython source top level directory using the following:

```
python setup.py test
```

This is actually equivalent to going to the `Tests` subdirectory and running:

```
python run_tests.py
```

You'll often want to run just some of the tests, and this is done like this:

```
python run_tests.py test_SeqIO.py test_AlignIO.py
```

When giving the list of tests, the `.py` extension is optional, so you can also just type:

```
python run_tests.py test_SeqIO test_AlignIO
```

To run the docstring tests (see section [15.3](#)), you can use

```
python run_tests.py doctest
```

By default, `run_tests.py` runs all tests, including the docstring tests.

If an individual test is failing, you can also try running it directly, which may give you more information.

Importantly, note that the individual unit tests come in two types:

- Simple print-and-compare scripts. These unit tests are essentially short example Python programs, which print out various output text. For a test file named `test_XXX.py` there will be a matching text file called `test_XXX` under the `output` subdirectory which contains the expected output. All that the test framework does to is run the script, and check the output agrees.
- Standard `unittest`-based tests. These will `import unittest` and then define `unittest.TestCase` classes, each with one or more sub-tests as methods starting with `test_` which check some specific aspect of the code. These tests should not print any output directly.

Currently, about half of the Biopython tests are `unittest`-style tests, and half are print-and-compare tests.

Running a simple print-and-compare test directly will usually give lots of output on screen, but does not check the output matches the expected output. If the test is failing with an exception error, it should be very easy to locate where exactly the script is failing. For an example of a print-and-compare test, try:

```
python test_SeqIO.py
```

The `unittest`-based tests instead show you exactly which sub-section(s) of the test are failing. For example,

```
python test_Cluster.py
```

15.2 Writing tests

Let's say you want to write some tests for a module called `Biospam`. This can be a module you wrote, or an existing module that doesn't have any tests yet. In the examples below, we assume that `Biospam` is a module that does simple math.

Each Biopython test can have three important files and directories involved with it:

1. `test_Biospam.py` – The actual test code for your module.
2. `Biospam` [optional]– A directory where any necessary input files will be located. Any output files that will be generated should also be written here (and preferably cleaned up after the tests are done) to prevent clogging up the main Tests directory.
3. `output/Biospam` – [for print-and-compare tests only] This file contains the expected output from running `test_Biospam.py`. This file is not needed for `unittest`-style tests, since there the validation is done in the test script `test_Biospam.py` itself.

It's up to you to decide whether you want to write a print-and-compare test script or a `unittest`-style test script. The important thing is that you cannot mix these two styles in a single test script. Particularly, don't use `unittest` features in a print-and-compare test.

Any script with a `test_` prefix in the `Tests` directory will be found and run by `run_tests.py`. Below, we show an example test script `test_Biospam.py` both for a print-and-compare test and for a `unittest`-based test. If you put this script in the Biopython `Tests` directory, then `run_tests.py` will find it and execute the tests contained in it:

```
$ python run_tests.py
test_Ace ... ok
test_AlignIO ... ok
test_BioSQL ... ok
test_BioSQL_SeqIO ... ok
test_Biospam ... ok
test_CAPS ... ok
test_Clustalw ... ok
```

...

Ran 107 tests in 86.127 seconds

15.2.1 Writing a print-and-compare test

A print-and-compare style test should be much simpler for beginners or novices to write - essentially it is just an example script using your new module.

Here is what you should do to make a print-and-compare test for the `Biospam` module.

1. Write a script called `test_Biospam.py`

- This script should live in the Tests directory
- The script should test all of the important functionality of the module (the more you test the better your test is, of course!).
- Try to avoid anything which might be platform specific, such as printing floating point numbers without using an explicit formatting string to avoid having too many decimal places (different platforms can give very slightly different values).

2. If the script requires files to do the testing, these should go in the directory `Tests/Biospam` (if you just need something generic, like a FASTA sequence file, or a GenBank record, try and use an existing sample input file instead).

3. Write out the test output and verify the output to be correct.

There are two ways to do this:

(a) The long way:

- Run the script and write its output to a file. On UNIX (including Linux and Mac OS X) machines, you would do something like: `python test_Biospam.py > test_Biospam` which would write the output to the file `test_Biospam`.
- Manually look at the file `test_Biospam` to make sure the output is correct. When you are sure it is all right and there are no bugs, you need to quickly edit the `test_Biospam` file so that the first line is: `'test_Biospam'` (no quotes).
- copy the `test_Biospam` file to the directory `Tests/output`

(b) The quick way:

- Run `python run_tests.py -g test_Biospam.py`. The regression testing framework is nifty enough that it'll put the output in the right place in just the way it likes it.
- Go to the output (which should be in `Tests/output/test_Biospam`) and double check the output to make sure it is all correct.

4. Now change to the Tests directory and run the regression tests with `python run_tests.py`. This will run all of the tests, and you should see your test run (and pass!).

5. That's it! Now you've got a nice test for your module ready to check in, or submit to Biopython. Congratulations!

As an example, the `test_Biospam.py` test script to test the `addition` and `multiplication` functions in the `Biospam` module could look as follows:

```

from Bio import Biospam

print "2 + 3 =", Biospam.addition(2, 3)
print "9 - 1 =", Biospam.addition(9, -1)
print "2 * 3 =", Biospam.multiplication(2, 3)
print "9 * (- 1) =", Biospam.multiplication(9, -1)

```

We generate the corresponding output with `python run_tests.py -g test_Biospam.py`, and check the output file `output/test_Biospam`:

```

test_Biospam
2 + 3 = 5
9 - 1 = 8
2 * 3 = 6
9 * (- 1) = -9

```

Often, the difficulty with larger print-and-compare tests is to keep track which line in the output corresponds to which command in the test script. For this purpose, it is important to print out some markers to help you match lines in the input script with the generated output.

15.2.2 Writing a unittest-based test

We want all the modules in Biopython to have unit tests, and a simple print-and-compare test is better than no test at all. However, although there is a steeper learning curve, using the `unittest` framework gives a more structured result, and if there is a test failure this can clearly pinpoint which part of the test is going wrong. The sub-tests can also be run individually which is helpful for testing or debugging.

The `unittest`-framework has been included with Python since version 2.1, and is documented in the Python Library Reference (which I know you are keeping under your pillow, as recommended). There is also [online documentaion for unittest](#). If you are familiar with the `unittest` system (or something similar like the nose test framework), you shouldn't have any trouble. You may find looking at the existing example within Biopython helpful too.

Here's a minimal `unittest`-style test script for `Biospam`, which you can copy and paste to get started:

```

import unittest
from Bio import Biospam

class BiospamTestAddition(unittest.TestCase):

    def test_addition1(self):
        result = Biospam.addition(2, 3)
        self.assertEqual(result, 5)

    def test_addition2(self):
        result = Biospam.addition(9, -1)
        self.assertEqual(result, 8)

class BiospamTestDivision(unittest.TestCase):

    def test_division1(self):
        result = Biospam.division(3.0, 2.0)
        self.assertAlmostEqual(result, 1.5)

    def test_division2(self):

```

```
result = Biospam.division(10.0, -2.0)
self.assertAlmostEqual(result, -5.0)
```

```
if __name__ == "__main__":
    runner = unittest.TextTestRunner(verbosity = 2)
    unittest.main(testRunner=runner)
```

In the division tests, we use `assertAlmostEqual` instead of `assertEqual` to avoid tests failing due to roundoff errors; see the `unittest` chapter in the Python documentation for details and for other functionality available in `unittest` ([online reference](#)).

These are the key points of `unittest`-based tests:

- Test cases are stored in classes that derive from `unittest.TestCase` and cover one basic aspect of your code
- You can use methods `setUp` and `tearDown` for any repeated code which should be run before and after each test method. For example, the `setUp` method might be used to create an instance of the object you are testing, or open a file handle. The `tearDown` should do any “tidying up”, for example closing the file handle.
- The tests are prefixed with `test_` and each test should cover one specific part of what you are trying to test. You can have as many tests as you want in a class.
- At the end of the test script, you can use

```
if __name__ == "__main__":
    runner = unittest.TextTestRunner(verbosity = 2)
    unittest.main(testRunner=runner)
```

to execute the tests when the script is run by itself (rather than imported from `run_tests.py`). If you run this script, then you’ll see something like the following:

```
$ python test_BiospamMyModule.py
test_addition1 (__main__.TestAddition) ... ok
test_addition2 (__main__.TestAddition) ... ok
test_division1 (__main__.TestDivision) ... ok
test_division2 (__main__.TestDivision) ... ok
```

```
-----
Ran 4 tests in 0.059s
```

```
OK
```

- To indicate more clearly what each test is doing, you can add docstrings to each test. These are shown when running the tests, which can be useful information if a test is failing.

```
import unittest
from Bio import Biospam

class BiospamTestAddition(unittest.TestCase):

    def test_addition1(self):
```

```

        """An addition test"""
        result = Biospam.addition(2, 3)
        self.assertEqual(result, 5)

    def test_addition2(self):
        """A second addition test"""
        result = Biospam.addition(9, -1)
        self.assertEqual(result, 8)

class BiospamTestDivision(unittest.TestCase):

    def test_division1(self):
        """Now let's check division"""
        result = Biospam.division(3.0, 2.0)
        self.assertAlmostEqual(result, 1.5)

    def test_division2(self):
        """A second division test"""
        result = Biospam.division(10.0, -2.0)
        self.assertAlmostEqual(result, -5.0)

if __name__ == "__main__":
    runner = unittest.TextTestRunner(verbosity = 2)
    unittest.main(testRunner=runner)

```

Running the script will now show you:

```

$ python test_BiospamMyModule.py
An addition test ... ok
A second addition test ... ok
Now let's check division ... ok
A second division test ... ok

```

```

-----
Ran 4 tests in 0.001s

```

OK

If your module contains docstring tests (see section [15.3](#)), you may want to include those in the tests to be run. You can do so as follows by modifying the code under `if __name__ == "__main__":` to look like this:

```

if __name__ == "__main__":
    unittest_suite = unittest.TestLoader().loadTestsFromName("test_Biospam")
    doctest_suite = doctest.DocTestSuite(Biospam)
    suite = unittest.TestSuite((unittest_suite, doctest_suite))
    runner = unittest.TextTestRunner(sys.stdout, verbosity = 2)
    runner.run(suite)

```

This is only relevant if you want to run the docstring tests when you execute `python test_Biospam.py`; with `python run_tests.py`, the docstring tests are run automatically (assuming they are included in the list of docstring tests in `run_tests.py`, see the section below).

15.3 Writing doctests

Python modules, classes and functions support built in documentation using docstrings. The [doctest framework](#) (included with Python) allows the developer to embed working examples in the docstrings, and have these examples automatically tested.

Currently only a small part of Biopython includes doctests. The `run_tests.py` script takes care of running the doctests. For this purpose, at the top of the `run_tests.py` script is a manually compiled list of modules to test, which allows us to skip modules with optional external dependencies which may not be installed (e.g. the Reportlab and NumPy libraries). So, if you've added some doctests to the docstrings in a Biopython module, in order to have them included in the Biopython test suite, you must update `run_tests.py` to include your module. Currently, the relevant part of `run_tests.py` looks as follows:

```
# This is the list of modules containing docstring tests.
# If you develop docstring tests for other modules, please add
# those modules here.
DOCTEST_MODULES = ["Bio.Seq",
                   "Bio.SeqRecord",
                   "Bio.SeqIO",
                   "Bio.Align.Generic",
                   "Bio.AlignIO",
                   "Bio.KEGG.Compound",
                   "Bio.KEGG.Enzyme",
                   "Bio.Wise",
                   "Bio.Wise.psw",
                  ]
#Silently ignore any doctests for modules requiring numpy!
try:
    import numpy
    DOCTEST_MODULES.extend(["Bio.Statistics.lowess"])
except ImportError:
    pass
```

Note that we regard doctests primarily as documentation, so you should stick to typical usage. Generally complicated examples dealing with error conditions and the like would be best left to a dedicated unit test.

Note that if you want to write doctests involving file parsing, defining the file location complicates matters. Ideally use relative paths assuming the code will be run from the `Tests` directory, see the `Bio.SeqIO` doctests for an example of this.

To run the docstring tests only, use

```
$ python run_tests.py doctest
```

Chapter 16

Advanced

16.1 Parser Design

Many of the older Biopython parsers were built around an event-oriented design that includes Scanner and Consumer objects.

Scanners take input from a data source and analyze it line by line, sending off an event whenever it recognizes some information in the data. For example, if the data includes information about an organism name, the scanner may generate an `organism_name` event whenever it encounters a line containing the name.

Consumers are objects that receive the events generated by Scanners. Following the previous example, the consumer receives the `organism_name` event, and the processes it in whatever manner necessary in the current application.

This is a very flexible framework, which is advantageous if you want to be able to parse a file format into more than one representation. For example, the `Bio.GenBank` module uses this construct either `SeqRecord` objects or file-format-specific record objects.

More recently, many of the parsers added for `Bio.SeqIO` and `Bio.AlignIO` take a much simpler approach, but only generate a single object representation (`SeqRecord` and `MultipleSeqAlignment` objects respectively). In some cases the `Bio.SeqIO` parsers actually wrap another Biopython parser - for example, the `Bio.SwissProt` parser produces SwissProt format specific record objects, which get converted into `SeqRecord` objects.

16.2 Substitution Matrices

16.2.1 SubsMat

This module provides a class and a few routines for generating substitution matrices, similar to BLOSUM or PAM matrices, but based on user-provided data. Additionally, you may select a matrix from `MatrixInfo.py`, a collection of established substitution matrices. The `SeqMat` class derives from a dictionary:

```
class SeqMat(dict)
```

The dictionary is of the form $\{(i1, j1):n1, (i1, j2):n2, \dots, (ik, jk):nk\}$ where i, j are alphabet letters, and n is a value.

1. Attributes

- (a) `self.alphabet`: a class as defined in `Bio.Alphabet`
- (b) `self.ab_list`: a list of the alphabet's letters, sorted. Needed mainly for internal purposes

2. Methods

- (a) `__init__(self, data=None, alphabet=None, mat_type=NOTYPE, mat_name='', build_later=0):`
- i. `data`: can be either a dictionary, or another SeqMat instance.
 - ii. `alphabet`: a Bio.Alphabet instance. If not provided, construct an alphabet from data.
 - iii. `mat_type`: type of matrix generated. One of the following:
 - NOTYPE** No type defined
 - ACCREP** Accepted Replacements Matrix
 - OBSFREQ** Observed Frequency Matrix
 - EXPFREQ** Expsected Frequency Matrix
 - SUBS** Substitution Matrix
 - LO** Log Odds Matrix`mat_type` is provided automatically by some of SubsMat's functions.
 - iv. `mat_name`: matrix name, such as "BLOSUM62" or "PAM250"
 - v. `build_later`: default false. If true, user may supply only alphabet and empty dictionary, if intending to build the matrix later. this skips the sanity check of alphabet size vs. matrix size.
- (b) `entropy(self, obs_freq_mat)`
- i. `obs_freq_mat`: an observed frequency matrix. Returns the matrix's entropy, based on the frequency in `obs_freq_mat`. The matrix instance should be LO or SUBS.
- (c) `sum(self)`
- Calculates the sum of values for each letter in the matrix's alphabet, and returns it as a dictionary of the form `{i1: s1, i2: s2, ..., in: sn}`, where:
- `i`: an alphabet letter;
 - `s`: sum of all values in a half-matrix for that letter;
 - `n`: number of letters in alphabet.
- (d) `print_mat(self, f, format="%4d", bottomformat="%4s", alphabet=None)`
- prints the matrix to file handle `f`. `format` is the format field for the matrix values; `bottomformat` is the format field for the bottom row, containing matrix letters. Example output for a 3-letter alphabet matrix:
- ```
A 23
B 12 34
C 7 22 27
 A B C
```
- The `alphabet` optional argument is a string of all characters in the alphabet. If supplied, the order of letters along the axes is taken from the string, rather than by alphabetical order.

### 3. Usage

The following section is layed out in the order by which most people wish to generate a log-odds matrix. Of course, interim matrices can be generated and investigated. Most people just want a log-odds matrix, that's all.

#### (a) Generating an Accepted Replacement Matrix

Initially, you should generate an accepted replacement matrix (ARM) from your data. The values in ARM are the counted number of replacements according to your data. The data could be a set of pairs or multiple alignments. So for instance if Alanine was replaced by Cysteine 10 times, and Cysteine by Alanine 12 times, the corresponding ARM entries would be:

('A','C'): 10, ('C','A'): 12

as order doesn't matter, user can already provide only one entry:

('A','C'): 22

A SeqMat instance may be initialized with either a full (first method of counting: 10, 12) or half (the latter method, 22) matrices. A full protein alphabet matrix would be of the size  $20 \times 20 = 400$ . A half matrix of that alphabet would be  $20 \times 20 / 2 + 20 / 2 = 210$ . That is because same-letter entries don't change. (The matrix diagonal). Given an alphabet size of N:

- i. Full matrix size:  $N \times N$
- ii. Half matrix size:  $N(N+1)/2$

The SeqMat constructor automatically generates a half-matrix, if a full matrix is passed. If a half matrix is passed, letters in the key should be provided in alphabetical order: ('A','C') and not ('C','A').

At this point, if all you wish to do is generate a log-odds matrix, please go to the section titled Example of Use. The following text describes the nitty-gritty of internal functions, to be used by people who wish to investigate their nucleotide/amino-acid frequency data more thoroughly.

(b) Generating the observed frequency matrix (OFM)

Use:

```
OFM = SubsMat._build_obs_freq_mat(ARM)
```

The OFM is generated from the ARM, only instead of replacement counts, it contains replacement frequencies.

(c) Generating an expected frequency matrix (EFM)

Use:

```
EFM = SubsMat._build_exp_freq_mat(OFM,exp_freq_table)
```

- i. `exp_freq_table`: should be a FreqTable instance. See section [16.2.2](#) for detailed information on FreqTable. Briefly, the expected frequency table has the frequencies of appearance for each member of the alphabet. It is implemented as a dictionary with the alphabet letters as keys, and each letter's frequency as a value. Values sum to 1.

The expected frequency table can (and generally should) be generated from the observed frequency matrix. So in most cases you will generate `exp_freq_table` using:

```
>>> exp_freq_table = SubsMat._exp_freq_table_from_obs_freq(OFM)
>>> EFM = SubsMat._build_exp_freq_mat(OFM,exp_freq_table)
```

But you can supply your own `exp_freq_table`, if you wish

(d) Generating a substitution frequency matrix (SFM)

Use:

```
SFM = SubsMat._build_subs_mat(OFM,EFM)
```

Accepts an OFM, EFM. Provides the division product of the corresponding values.

(e) Generating a log-odds matrix (LOM)

Use:

```
LOM=SubsMat._build_log_odds_mat(SFM[,logbase=10,factor=10.0,round_digit=1])
```

- i. Accepts an SFM.
- ii. `logbase`: base of the logarithm used to generate the log-odds values.

- iii. **factor**: factor used to multiply the log-odds values. Each entry is generated by  $\log(\text{LOM}[\text{key}]) \times \text{factor}$ . And rounded to the **round\_digit** place after the decimal point, if required.

#### 4. Example of use

As most people would want to generate a log-odds matrix, with minimum hassle, SubsMat provides one function which does it all:

```
make_log_odds_matrix(acc_rep_mat,exp_freq_table=None,logbase=10,
 factor=10.0,round_digit=0):
```

- (a) **acc\_rep\_mat**: user provided accepted replacements matrix
- (b) **exp\_freq\_table**: expected frequencies table. Used if provided, if not, generated from the **acc\_rep\_mat**.
- (c) **logbase**: base of logarithm for the log-odds matrix. Default base 10.
- (d) **round\_digit**: number after decimal digit to which result should be rounded. Default zero.

### 16.2.2 FreqTable

`FreqTable.FreqTable(UserDict.UserDict)`

#### 1. Attributes:

- (a) **alphabet**: A `Bio.Alphabet` instance.
- (b) **data**: frequency dictionary
- (c) **count**: count dictionary (in case counts are provided).

#### 2. Functions:

- (a) **read\_count(f)**: read a count file from stream `f`. Then convert to frequencies
- (b) **read\_freq(f)**: read a frequency data file from stream `f`. Of course, we then don't have the counts, but it is usually the letter frequencies which are interesting.

#### 3. Example of use: The expected count of the residues in the database is sitting in a file, whitespace delimited, in the following format (example given for a 3-letter alphabet):

```
A 35
B 65
C 100
```

And will be read using the `FreqTable.read_count(file_handle)` function.

An equivalent frequency file:

```
A 0.175
B 0.325
C 0.5
```

Conversely, the residue frequencies or counts can be passed as a dictionary. Example of a count dictionary (3-letter alphabet):

```
{ 'A': 35, 'B': 65, 'C': 100 }
```

Which means that an expected data count would give a 0.5 frequency for 'C', a 0.325 probability of 'B' and a 0.175 probability of 'A' out of 200 total, sum of A, B and C)

A frequency dictionary for the same data would be:

```
{'A': 0.175, 'B': 0.325, 'C': 0.5}
```

Summing up to 1.

When passing a dictionary as an argument, you should indicate whether it is a count or a frequency dictionary. Therefore the FreqTable class constructor requires two arguments: the dictionary itself, and FreqTable.COUNT or FreqTable.FREQ indicating counts or frequencies, respectively.

Read expected counts. readCount will already generate the frequencies Any one of the following may be done to generate the frequency table (ftab):

```
>>> from SubsMat import *
>>> ftab = FreqTable.FreqTable(my_frequency_dictionary, FreqTable.FREQ)
>>> ftab = FreqTable.FreqTable(my_count_dictionary, FreqTable.COUNT)
>>> ftab = FreqTable.read_count(open('myCountFile'))
>>> ftab = FreqTable.read_frequency(open('myFrequencyFile'))
```

## Chapter 17

# Where to go from here – contributing to Biopython

### 17.1 Bug Reports + Feature Requests

Getting feedback on the Biopython modules is very important to us. Open-source projects like this benefit greatly from feedback, bug-reports (and patches!) from a wide variety of contributors.

The main forums for discussing feature requests and potential bugs are the [Biopython mailing lists](#):

- [biopython@biopython.org](mailto:biopython@biopython.org) – An unmoderated list for discussion of anything to do with Biopython.
- [biopython-dev@biopython.org](mailto:biopython-dev@biopython.org) – A more development oriented list that is mainly used by developers (but anyone is free to contribute!).

Additionally, if you think you've found a bug, you can submit it to our bug-tracking page at <http://bugzilla.open-bio.org/>. This way, it won't get buried in anyone's Inbox and forgotten about.

### 17.2 Mailing lists and helping newcomers

We encourage all our users to sign up to the main Biopython mailing list. Once you've got the hang of an area of Biopython, we'd encourage you to help answer questions from beginners. After all, you were a beginner once.

### 17.3 Contributing Documentation

We're happy to take feedback or contributions - either via a bug-report or on the Mailing List. While reading this tutorial, perhaps you noticed some topics you were interested in which were missing, or not clearly explained. There is also Biopython's built in documentation (the docstrings, these are also [online](#)), where again, you may be able to help fill in any blanks.

### 17.4 Contributing cookbook examples

As explained in Chapter 14, Biopython now has a wiki collection of user contributed “cookbook” examples, <http://biopython.org/wiki/Category:Cookbook> – maybe you can add to this?

## 17.5 Maintaining a distribution for a platform

We currently provide source code archives (suitable for any OS, if you have the right build tools installed), and Windows Installers which are just click and run. This covers all the major operating systems.

Most major Linux distributions have volunteers who take these source code releases, and compile them into packages for Linux users to easily install (taking care of dependencies etc). This is really great and we are of course very grateful. If you would like to contribute to this work, please find out more about how your Linux distribution handles this.

Below are some tips for certain platforms to maybe get people started with helping out:

**Windows** – Windows products typically have a nice graphical installer that installs all of the essential components in the right place. We use Distutils to create an installer of this type fairly easily.

You must first make sure you have a C compiler on your Windows computer, and that you can compile and install things (this is the hard bit - see the Biopython installation instructions for info on how to do this).

Once you are setup with a C compiler, making the installer just requires doing:

```
python setup.py bdist_wininst
```

Now you've got a Windows installer. Congrats! At the moment we have no trouble shipping installers built on 32 bit windows. If anyone would like to look into supporting 64 bit Windows that would be great.

**RPMs** – RPMs are pretty popular package systems on some Linux platforms. There is lots of documentation on RPMs available at <http://www.rpm.org> to help you get started with them. To create an RPM for your platform is really easy. You just need to be able to build the package from source (having a C compiler that works is thus essential) – see the Biopython installation instructions for more info on this.

To make the RPM, you just need to do:

```
python setup.py bdist_rpm
```

This will create an RPM for your specific platform and a source RPM in the directory `dist`. This RPM should be good and ready to go, so this is all you need to do! Nice and easy.

**Macintosh** – Since Apple moved to Mac OS X, things have become much easier on the Mac. We generally treat it as just another Unix variant, and installing Biopython from source is just as easy as on Linux. The easiest way to get all the GCC compilers etc installed is to install Apple's X-Code. We might be able to provide click and run installers for Mac OS X, but to date there hasn't been any demand.

Once you've got a package, please test it on your system to make sure it installs everything in a good way and seems to work properly. Once you feel good about it, send it off to one of the Biopython developers (write to our main mailing list at [biopython@biopython.org](mailto:biopython@biopython.org) if you're not sure who to send it to) and you've done it. Thanks!

## 17.6 Contributing Unit Tests

Even if you don't have any new functionality to add to Biopython, but you want to write some code, please consider extending our unit test coverage. We've devoted all of Chapter 15 to this topic.

## 17.7 Contributing Code

There are no barriers to joining Biopython code development other than an interest in creating biology-related code in Python. The best place to express an interest is on the Biopython mailing lists – just let us know you are interested in coding and what kind of stuff you want to work on. Normally, we try to have some discussion on modules before coding them, since that helps generate good ideas – then just feel free to jump right in and start coding!

The main Biopython release tries to be fairly uniform and interworkable, to make it easier for users. You can read about some of (fairly informal) coding style guidelines we try to use in Biopython in the contributing documentation at <http://biopython.org/wiki/Contributing>. We also try to add code to the distribution along with tests (see Chapter 15 for more info on the regression testing framework) and documentation, so that everything can stay as workable and well documented as possible (including docstrings). This is, of course, the most ideal situation, under many situations you'll be able to find other people on the list who will be willing to help add documentation or more tests for your code once you make it available. So, to end this paragraph like the last, feel free to start working!

Please note that to make a code contribution you must have the legal right to contribute it and license it under the Biopython license. If you wrote it all yourself, and it is not based on any other code, this shouldn't be a problem. However, there are issues if you want to contribute a derivative work - for example something based on GPL or LGPL licenced code would not be compatible with our license. If you have any queries on this, please discuss the issue on the biopython-dev mailing list.

Another point of concern for any additions to Biopython regards any build time or run time dependencies. Generally speaking, writing code to interact with a standalone tool (like BLAST, EMBOSS or ClustalW) doesn't present a big problem. However, any dependency on another library - even a Python library (especially one needed in order to compile and install Biopython like NumPy) would need further discussion.

Additionally, if you have code that you don't think fits in the distribution, but that you want to make available, we maintain Script Central (<http://biopython.org/wiki/Scriptcentral>) which has pointers to freely available code in Python for bioinformatics.

Hopefully this documentation has got you excited enough about Biopython to try it out (and most importantly, contribute!). Thanks for reading all the way through!



## Chapter 18

# Appendix: Useful stuff about Python

If you haven't spent a lot of time programming in Python, many questions and problems that come up in using Biopython are often related to Python itself. This section tries to present some ideas and code that come up often (at least for us!) while using the Biopython libraries. If you have any suggestions for useful pointers that could go here, please contribute!

### 18.1 What the heck is a handle?

Handles are mentioned quite frequently throughout this documentation, and are also fairly confusing (at least to me!). Basically, you can think of a handle as being a “wrapper” around text information.

Handles provide (at least) two benefits over plain text information:

1. They provide a standard way to deal with information stored in different ways. The text information can be in a file, or in a string stored in memory, or the output from a command line program, or at some remote website, but the handle provides a common way of dealing with information in all of these formats.
2. They allow text information to be read incrementally, instead of all at once. This is really important when you are dealing with huge text files which would use up all of your memory if you had to load them all.

Handles can deal with text information that is being read (e. g. reading from a file) or written (e. g. writing information to a file). In the case of a “read” handle, commonly used functions are `read()`, which reads the entire text information from the handle, and `readline()`, which reads information one line at a time. For “write” handles, the function `write()` is regularly used.

The most common usage for handles is reading information from a file, which is done using the built-in Python function `open`. Here, we open a handle to the file `m_cold.fasta` (also available online [here](#)):

```
>>> handle = open("m_cold.fasta", "r")
>>> handle.readline()
">gi|8332116|gb|BE037100.1|BE037100 MP14H09 MP Mesembryanthemum ... \n"
```

Handles are regularly used in Biopython for passing information to parsers.

#### 18.1.1 Creating a handle from a string

One useful thing is to be able to turn information contained in a string into a handle. The following example shows how to do this using `cStringIO` from the Python standard library:

```
>>> my_info = 'A string\n with multiple lines.'
>>> print my_info
A string
 with multiple lines.
>>> import cStringIO
>>> my_info_handle = cStringIO.StringIO(my_info)
>>> first_line = my_info_handle.readline()
>>> print first_line
A string

>>> second_line = my_info_handle.readline()
>>> print second_line
 with multiple lines.
```